

P-22-16 (updated October 3, 2022)

Petition Summary

Request to rezone a 4.0 acre property from Residence-B to Planned Unit Development (PUD) for a mixed-use (multi-family and single-family) residential development.

Recent Background-Update

On September 6, 2022 the applicant requested that this case be carried over to the meeting of October 3, 2022, in that proposed plans had been updated. The proposed changes to the PUD are as follows:

- Removed the alley and the Homewood lot from the proposal
- Removed pool from condo development
- Relocated service yards in condo buildings
- Revised parking layouts to accommodate 2 parking spaces/ unit
- Undergrounding the overhead electric lines between the condo development and the Chester Road lots, allowing for a higher, denser landscape buffer along that shared property line.
- Modified the privacy wall along the Miller and Kilpatrick properties to be 8'-0" tall, which will step down to 6'-0" around the Chester Road ROW.
- Modified the entry on Chester Road to include an automatic vehicular gate and a cobblestone entry drive.
- Reduced the density in Condo B by removing the south-facing penthouse units, reducing the total unit count in Condo B from 16 units to 14 units.
- Included conceptual floor plans and elevations for each condo building.

Board of Landscape Design Recommendations for PUD

The city's Board of Landscape Design (BLD) is primarily charged with trees and plantings on public property; however their input has been given on certain projects of interest, such as the public parks in the Lane Parke PUD.

Attached is a narrative of BLD's comments and suggestions for the Hollywood Gateway PUD, as well as a marked-up landscape plan (BLD's comments are in the left and bottom margins). The applicant will not have had a chance to incorporate any of these landscape suggestions into the PUD plan being considered by the planning commission on October 3, 2022. However, if the planning commission wishes to recommend that any of these landscape suggestions be incorporated into the PUD, such suggestions could accompany its recommendations to the city council.

Requests of Planning Commission

On August 1, 2022, the planning commission held a public hearing on the subject case, and carried it over to the meeting of September 6, 2022, making the following requests:

”Critical to the furtherance of the Planning Commission’s deliberations:

- Determine if the triangular-shaped western portion of the property in question is under Mountain Brook or Homewood jurisdiction; remove it from the application until such a time as jurisdiction is determined.
- Propose a clear direction for the use of the public alley along the west property line, how it will be incorporated into the proposed 20-foot wide ingress/egress drive, and who will maintain it.
- Parking for condominium buildings: The proposal for a reduced parking ratio (less than 2/unit) shall be based on demonstrated and convincing market and demographic data regarding the parking demand per each dwelling type included in the mix.”

Original Report from July 6, 2022

The original staff report and PUD plans from the July 6, 2022 planning commission meeting are attached for context and comparison to revisions to the PUD to date.

Re : Comments, Shades Valley PUD

1. Buffer Strip – Consider a vegetated buffer strip at all edges of the development that abut neighboring properties – minimum 10-feet.
2. The streetscape at Chester Road should include a mixed evergreen hedge as opposed to a regimented single plant material, planted in straight lines. Suggested selections:
 - Magnolias
 - Nellie Stevens Hollies
 - Foster Hollies
 - Camellias
3. Screen Walls - Should be architecturally detailed, referencing the overall design style, covered with Fig Vine, Trailing Clematis, Roses, etc., to soften the brick and appear more residential.
4. Montevallo Road Streetscape - Hardwoods and an understory of small ornamental flowering trees, willow trees (no Crepe myrtles) (for example Carriage Place on Montevallo), boxwood and hydrangea could artfully be employed to emphasize the residential setting, avoiding straight lines.
5. Sidewalk at Montevallo: Ramp to the underground parking interrupts the sidewalk and pushes pedestrians into the road.
 - Consider alternatives that provide a safe crossing for pedestrians with good visibility.
 - Due to grading constraints in the center (ramp length and elevation change force the sidewalk interruption), consider entering the underground parking from the ends.
6. Consider requiring separate Landscape “Planting Plan” review approval, when more specific Drawings are developed. Current plans indicate a wide range of possibilities.

HOLLYWOOD BOULEVARD GATEWAY PUD



2305 MONTEVALLO ROAD

SUBMITTED 08.19.2022

INGRAM FARRIS LLC

NEQUETTE ARCHITECTURE & DESIGN

SCHOEL ENGINEERING

SKIPPER CONSULTING

BRASFIELD & GORRIE

TABLE OF CONTENTS

1. PUD Rezoning Application2

2. Defined Terms & Site Legend3

3. Statement of Development Objectives4

4. Master Development Plan6

5. Permitted Land Use Map7

6. Permitted Land Uses8

7. Open Space & Pervious Surfaces Plan.....9

8. Base Zoning District Standards10

9. Design Standards & Pattern Book15

10. Vicinity Map with Current Zoning31

11. Survey32

12. Utilities and Storm Drainage Plan.....33

13. Legal Descriptions.....34

14. Appendices35

A. Appendix A: Traffic Study36

B. Appendix B: Renderings...106

C. Appendix C: Three-Dimensional Model Images.....110

D. Appendix D: Conceptual Landscape Plan114

E. Subdivision Covenants118

F. Condominium Declaration.....162

G. Condominium Plans & Elevations.....218



Planning Commission Application PART I

Project Data

Address of Subject Property 2305 Montevallo Road - Birmingham, Alabama - 35223

Zoning Classification PUD

Name of Property Owner(s) Shades Valley Presbyterian Church c/o Dave Dresher

Phone Number Dave Dresher Email ddresher@cjd.law

Name of Representative Agent (if applicable)

John Chapman

Phone Number 205.939.1222 Email jchapman@wynnecapitalpartners.com

Name of Engineer or Surveyor Andrew Phillips - Schoel Engineering

Phone Number 205.313.1154 Email aphillips@schoel.com

Property owner or representative agent must be present at hearing

Plans

See applicable Section of the Zoning Ordinance for submittal requirements pertaining to your particular application. Applicable Code Section may be found in Part II, list of application types. Contact City Planner with any specific questions as to required plans submittal.

2305 Montevallo Road Partners, LLC

2400 Arlington Avenue South
Birmingham, Alabama 35205

September 16, 2022

Ms. Dana O. Hazen, AICP
Director of Planning, Building and Sustainability
City of Mountain Brook

RE: Consent to Application, Case Number P-22-16

The undersigned, 2305 Montevallo Partners, LLC, hereby confirms that it has acquired title to the property which is the subject of the above captioned case, which is pending before the Planning Commission of the City of Mountain Brook, and that it hereby consents to and joins in the pending application as Applicant.

Dated this 16th day of September, 2022.

2305 Montevallo Partners, LLC



By: John F. Chapman

It's: Managing Member

2. DEFINITIONS

As used in this PUD Application, the following terms are defined as follows:

1. **Architectural Styles** means the Architectural Styles more particularly described in the Pattern Book.
2. **Building Typologies** means the permitted building types and specifications more particularly described in the Pattern Book.
3. **City** means the City of Mountain Brook, Alabama.
4. **City Code** means the Code of the City of Mountain Brook, Alabama.
5. **City Council** means the City Council of the City of Mountain Brook, Alabama.
6. **Design Committee** means the City's village design review committee as defined in the City Code.
7. **Design Review Process** means the Design Review Process described in Section 9 of this PUD Application.
8. **Design Standards** means the Design Standards set forth in this PUD Application.
9. **Gross Floor Area** means the total enclosed floor area of all floors of a building (including mezzanines), measured from the exterior faces of exterior walls and from the center line of walls separating buildings, including basements, lobbies, common areas, elevator shafts, stairwells, mechanical or equipment rooms, common corridors, building amenity areas, storage areas, enclosed garages, and any other fully enclosed spaces of the building, whether leased to tenants or not. Gross Floor Area shall exclude rooftops, plazas, covered walkways, covered parking areas, outdoor dining or market areas, balconies, porches, terraces, loading docks, roof overhangs and any other non-enclosed areas (whether covered by a roof or not).
10. **Illustrative Master Plan** means the Illustrative Master Plan included in this PUD Application.
11. **Landscape Standards** means the Landscape Standards set forth in the Landscaping, Parks and Open Space Plan included in this PUD Application.
12. **Master Association** means any Master Association created in connection with the Master Declaration of Restrictions and Easements more particularly described in this PUD Application.
13. **Parcel** means the corresponding parcel of land identified as Parcel "1 – 3" on the Site Legend or any other legal parcel of land within the subject property currently existing or created in the future by a Preliminary or Final Subdivision Plat submitted in connection with the development.
14. **Pattern Book** means the Pattern Book included in this PUD Application.
15. **Permitted Density** means the total number of unique dwelling units permitted to be constructed within the development, as more particularly set forth in this PUD Application.
16. **Phase(s)** means any one or more of the phases of anticipated construction, consisting of an Earthwork phase, Multi-Family Residential phase, & a Single-Family Residential phase, each as more particularly described and shown in this PUD Application.
17. **Planning Commission** means the Planning Commission of the City of Mountain Brook, Alabama.
18. **Property** means the real property more particularly described in this PUD Application that is to be re-zoned to a Planned Unit Development District.
19. **Project Owner** means Ingram Farris, LLC., an Alabama limited liability corporation, and its successors and/or assigns.
20. **PUD Application** means this document, all schedules and exhibits attached hereto or provided in connection herewith, and all amendments and modifications hereto.
21. **Regulating Plan** means the Regulating Plan more particularly described in the Pattern Book.
22. **Residential Infill District** means the regulations and standards for the Residential Infill District set forth in Sections 129-491 through 129-499 of the City Code as in effect as of January 1, 2012.
23. **Unit** means any dwelling unit created on any Parcel within the Property.
24. **Use Area** means any of the Use Areas more particularly described in this PUD Application.
25. **Village Master Plan** means the Village Master Plans adopted by the Planning Commission as of June, 2007.
26. **Village Overlay Standards** means the regulations and standards for the Village Overlay District set forth in Sections 129-551 through 129-558 of the City Code as in effect as of January 1, 2012.



SITE LOCATOR MAP
NTS

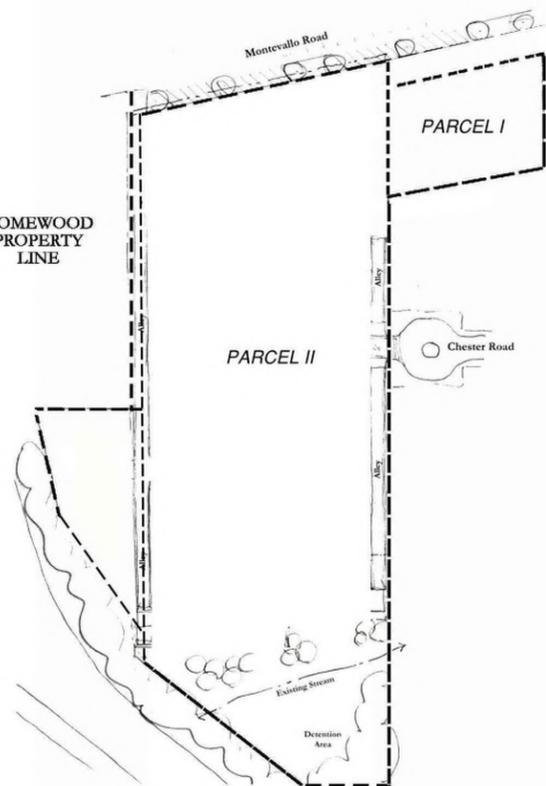

SITE LEGEND
NTS



3. DEVELOPMENT OBJECTIVES

Consistent with the goals and ideals of the Village Master Plans, 2305 Montevallo Road has been designed and planned around the following concepts:

- To be a Gateway into Mountain Brook Village that enhances and preserves the diversity of its architectural heritage and extends and encourages a pedestrian-scaled walkable village core.
- To enhance the Village by cultivating pedestrian connections, adding green space, improving storm water mitigation measures and providing ample parking.
- To create a variety of housing options aimed to attract empty nesters and current residents that want to live in a walkable environment while downsizing the space they need and minimizing the maintenance they are responsible for. When completed, this development will replace the defunct Shades Valley Presbyterian Church property with updated residential options not widely available in the surrounding area.
- The ±4 acre Property is ideally suited to act as a Village Core Gateway when comprehensively planned in accordance with the Planned Unit Development zoning classification established pursuant to Section 129-261 of the City Code. Accordingly, the Hollywood Boulevard Gateway Plan has been conceived in accordance with the following planning objectives:

1. To advance the vision for Mountain Brook Village as articulated in the Village Master Plans by (i) creating new development at the gateway of the Village that will contribute to the vitality of the Village as a whole, (ii) providing housing options that allow current residents to remain in Mountain Brook as their needs change, and (iii) attract new residents by offering housing options not prevalent in the surrounding area.
2. To preserve the character and tradition of Mountain Brook Village as a pedestrian friendly, community-oriented destination by extending that pedestrian-oriented environment from the village core to the gateway.
3. To design, construct and operate the gateway development in a manner that is sympathetic to the existing Village and minimizes impacts on adjacent neighborhoods by focusing on transitions between uses, setbacks, topography, vegetation, screening, and green space.
4. To complement the existing aesthetic of Mountain Brook Village by emphasizing architectural quality and promoting attractive and pedestrian oriented streetscapes.
5. To address current drainage and water management concerns by reducing the amount of impervious surface on-site and augmenting the existing storm water management system.
6. To minimize impact on existing traffic circulation by limiting access points while improving emergency access and circulation.
7. To minimize disruptions to the surrounding properties through restricted construction access.



EXISTING CONDITIONS



6/8/2022, 2:29:55 PM

- Municipal Boundary
- Lot Lines
- Tax Parcels 2021
- Community Shopping
- Local Business District
- Office Park District
- PUD
- Residence B District
- 2018 Aerial
- Red: Band_1
- Green: Band_2
- Blue: Band_3

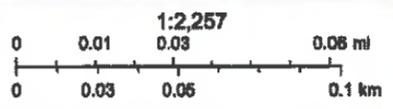

Source: Esri, HERE, Garmin, Intermap, increment P Corp., GEBCO, USGS, FAO, NPS, NRCAN, GeoBase, IGN, Kadaster NL, Ordnance Survey, Esri
AerGIS Web AppBuilder
JeffCoAL, Esri, HERE, Garmin, GeoTechnologies, Inc., USGS, EPA, USDA | Jefferson County Information Technology Services | Hunter Simmons |

MUNICIPAL BOUNDARY

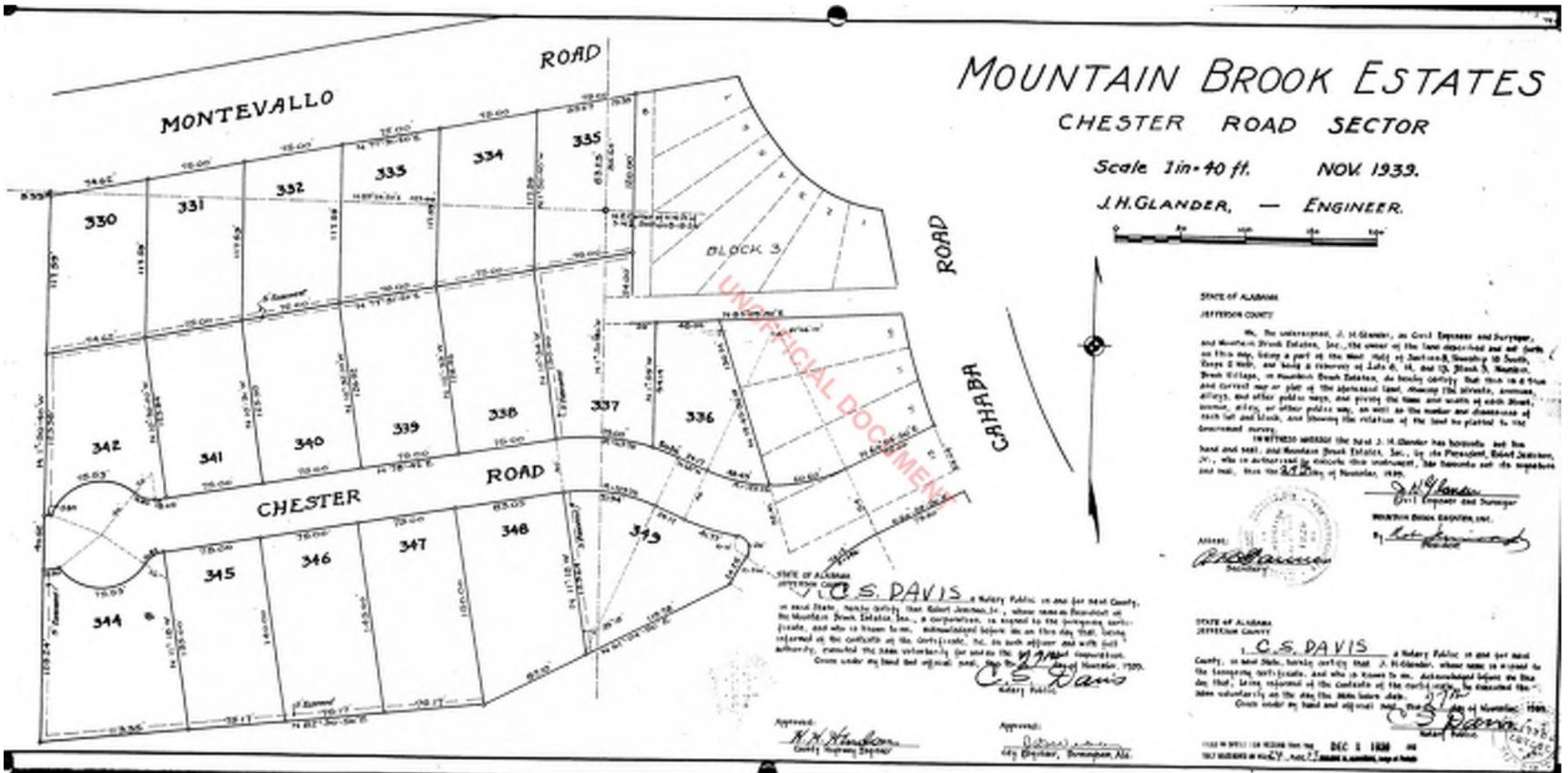

CHESTER ROAD SECTOR MAP

4. MASTER DEVELOPMENT PLAN

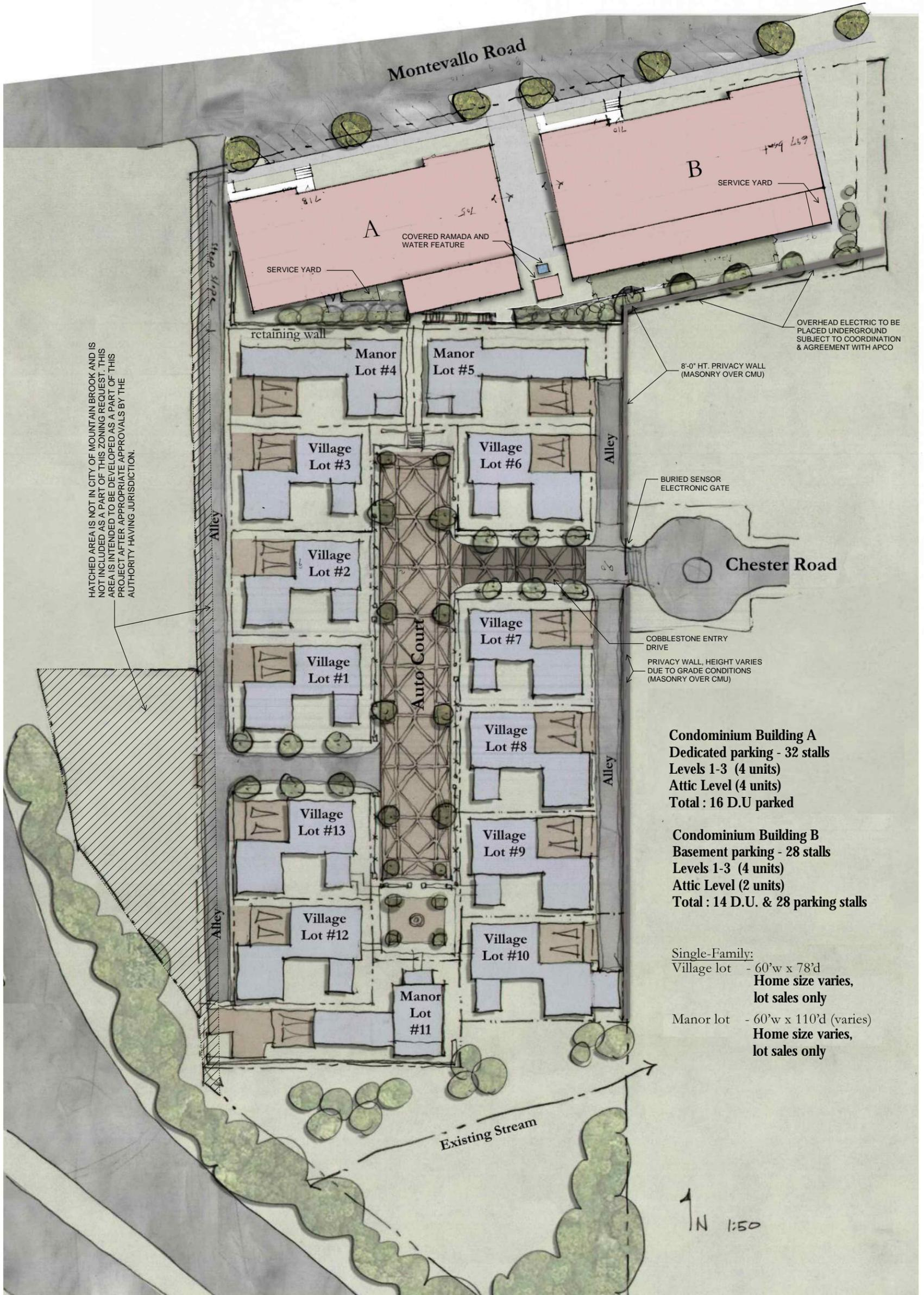

5. LAND USE PLAN

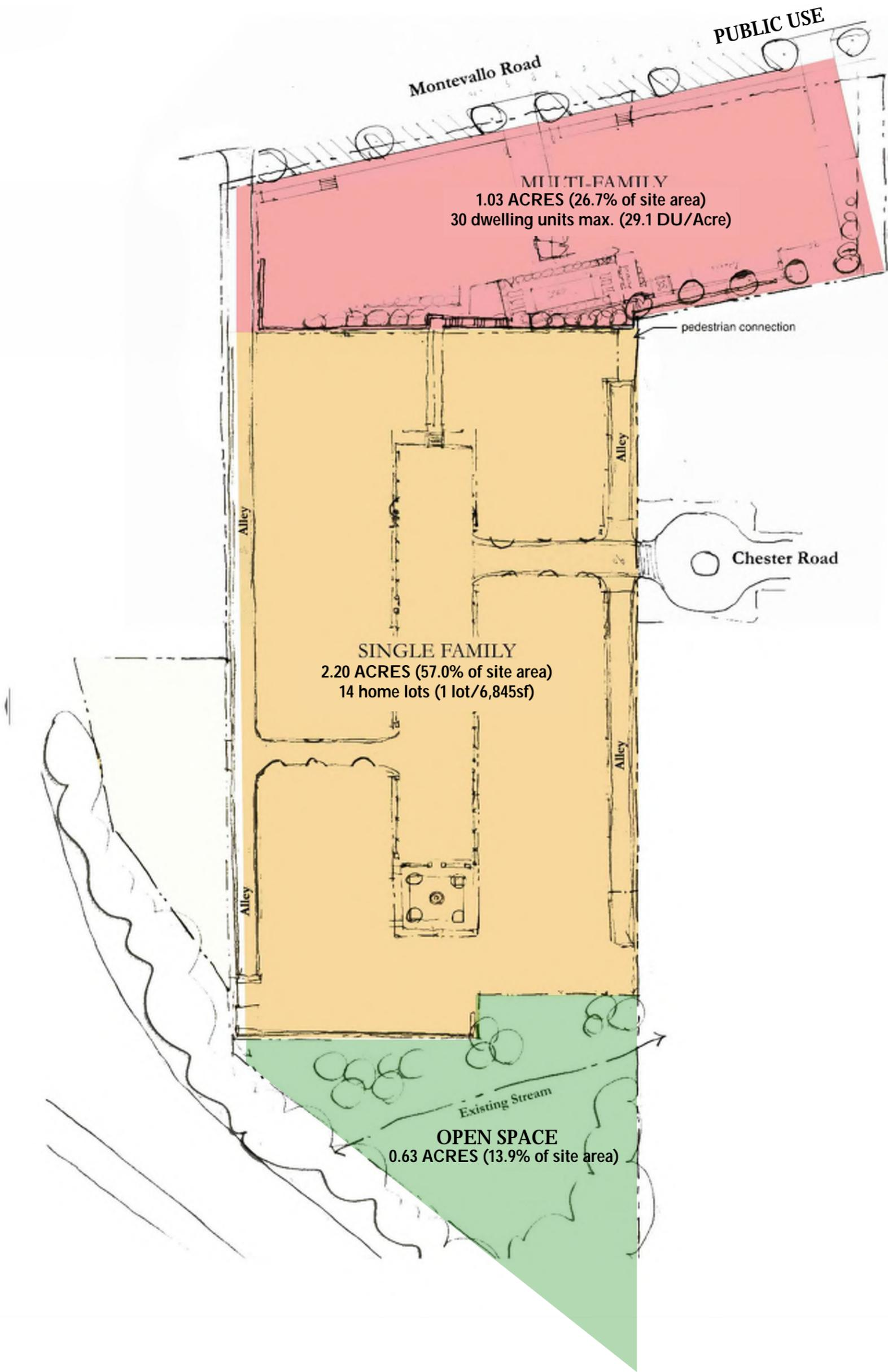

- MULTIFAMILY - APPROXIMATELY ONE ACRE CONTAINING 32 CONDOMINIUM UNITS AND 48 COVERED PARKING STALLS
- SINGLE-FAMILY - APPROXIMATELY TWO AND A QUARTER ACRES CONTAINING 14 CUSTOM HOME LOTS
- OPEN SPACE - APPROXIMATELY ONE-HALF ACRE

6. PERMITTED USES

Multifamily Use Area:

Within areas designated Multifamily Use Area, the following uses are permitted by right:

1. Residential dwelling units, provided however, the Multifamily Use Area shall not include more than thirty-two (32) residential dwelling units;
2. Enclosed garages and covered parking;
3. Sales offices;
4. Amenities, improvements, storage and mechanical uses ancillary to residential dwelling units, including but not limited to a pool, gym, laundry/cleaning services and recreational facilities;
5. Streets, rights of way, service roads, access ways and drive aisles (both public and private); and
6. Sidewalks and pedestrian passage ways.

Single family Use Area:

Within areas designated Single family Use Area, the following uses are permitted by right:

1. Residential dwelling units, provided however, the single family Use Area shall not include more than thirteen (14) residential lots;
2. Enclosed garages and covered parking;
3. Sales offices;
4. Amenities, improvements, storage and mechanical uses ancillary to residential dwelling units, including but not limited to a pool, gym, laundry/cleaning services and recreational facilities;
5. Streets, rights of way, service roads, access ways and drive aisles (both public and private); and
6. Sidewalks and pedestrian passage ways.

Open Space Use Area:

Within areas designated Open Space Use Area, the following uses are permitted by right:

1. Parks;
2. Playgrounds;
3. Green space;
4. Trails;

Public Use Area:

Within areas designated Public Use Area, the following uses are permitted by right:

1. Streets, rights of way, service roads, access ways and drive aisles (both public and private);
2. Sidewalks and pedestrian passage ways;
3. Special events, including festivals, parades, races, assemblies, gatherings and other events permitted under the City Code, provided such special events are sponsored and the sponsor thereof satisfies all requirements of the City Code with respect thereto.

EXISTING CONDITIONS

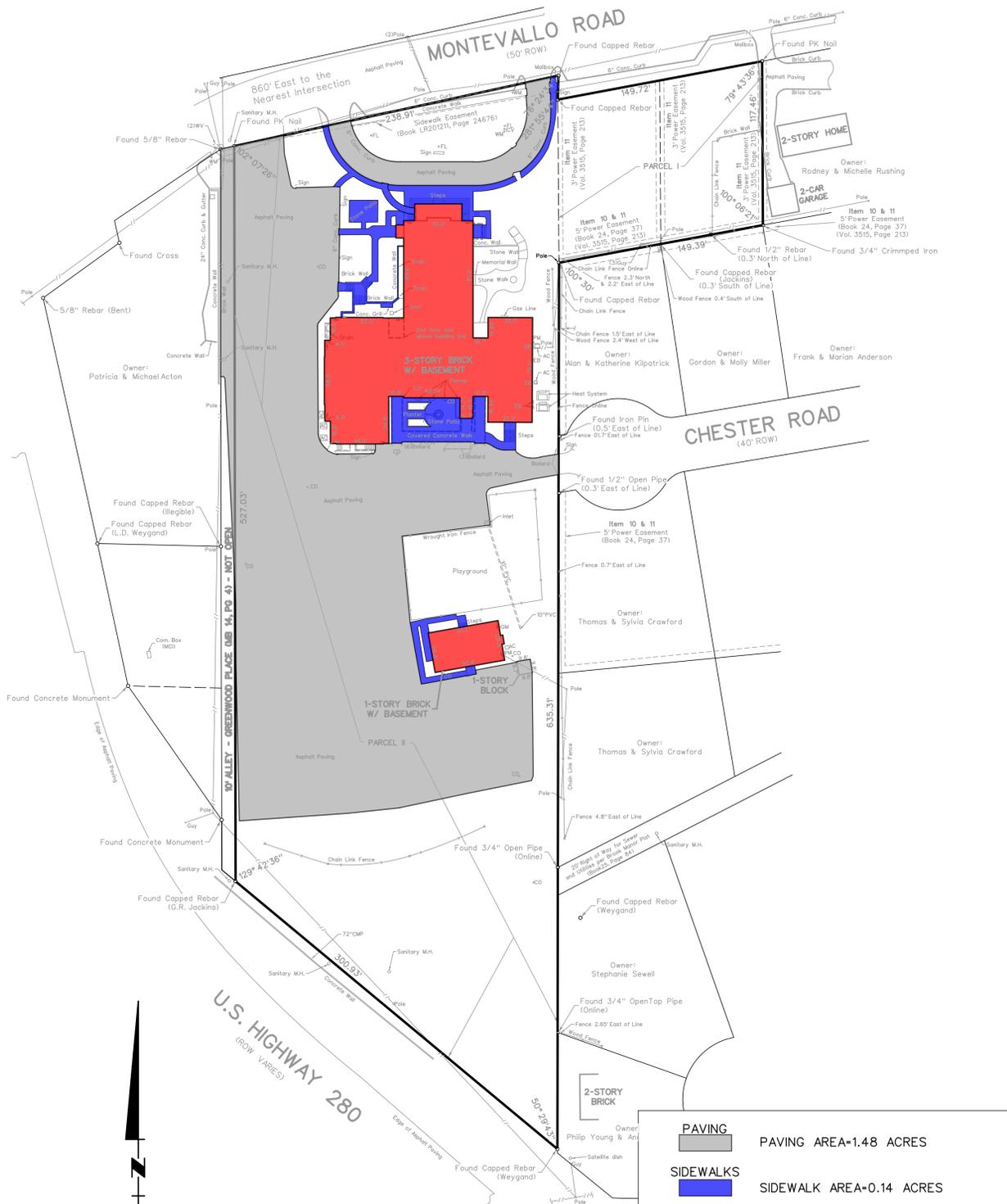

	PAVING AREA=1.48 ACRES
	SIDEWALK AREA=0.14 ACRES
	BUILDING AREA=0.37 ACRES
TOTAL IMPERVIOUS AREA=1.99 ACRES	
TOTAL ACREAGE=3.86 ACRES	
IMPERVIOUS % = 52%	

Scale: 1" = 50'
Graphic Scale



PROPOSED CONDITIONS

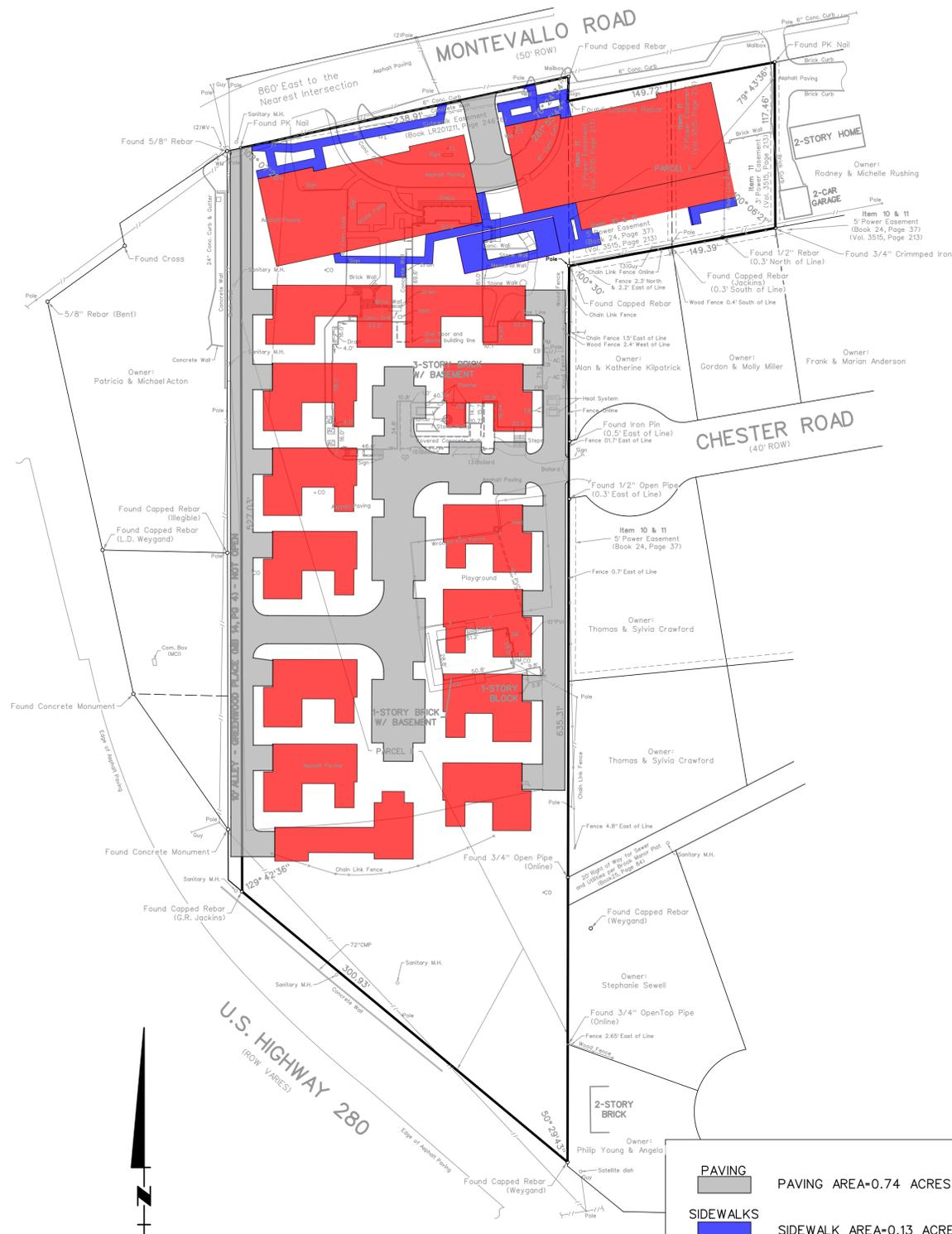

	PAVING AREA=0.74 ACRES
	SIDEWALK AREA=0.13 ACRES
	BUILDING AREA=1.25 ACRES
TOTAL IMPERVIOUS AREA=2.12 ACRES	
TOTAL ACREAGE=3.86 ACRES	
IMPERVIOUS AREA % = 55%	

Scale: 1" = 50'
Graphic Scale



IMPERVIOUS AREA EXHIBIT HOLLYWOOD BOULEVARD GATEWAY

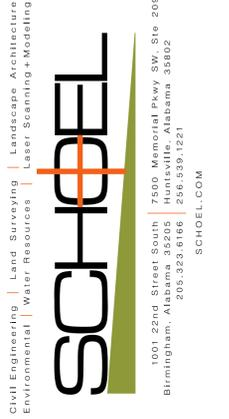

1001 22nd Street South
Birmingham, Alabama 35205
205-320-0166 | 256-539-1221
Huntsville, Alabama 35892
SCHOEEL.COM

DATE: AUGUST 19, 2022
Copyright © 2022 School Engineering Company, Inc.

8. MULTIFAMILY ZONING DATA

Multifamily Zoning (Village Overlay - Stacked Flats Building Type; Residence G)			
	BASE ZONING DISTRICT	PROPOSED PLAN	CAUSE OF DEVIATION
Purpose	(a)General purposes. The village overlay standards are designed to:(1)Implement the village master plans, officially recommended by the planning commission as part of the overall master plan for the City of Mountain Brook and promote the health, safety, morals and general welfare of the community.(2)Provide for the kind, character and use of structures and improvements that may be erected or made within the villages, to promote and preserve the unique character and encourage pedestrian use of each of the villages.(3)Regulate the erection, construction, reconstruction, alteration, repair or use of buildings, structures or land subject to the standards, in conformance with the village master plan.(4)To permit differences in the height, mass, scale, design, type, and uses of buildings subject to the standards based on the relationship of sites to specific public streets, open spaces, and to surrounding parcels.(5)To allow coordinated development in the villages according to a comprehensive master plan that best complements the design and investment by the city in streets, open space and other public infrastructure.	Complies	None
Permitted Uses	(a)Uses. The uses permitted in areas subject to the village overlay standards are those authorized by the base zoning district for each parcel. (b)Building types. Stacked Flats building types are allowed on residential street frontage. Differences in size, placement, orientation and design of each building type are regulated by this article, and the applicable building and development regulating plan.	Complies	None
Stacked Flats building type			
Site Specifications			
Required lot width	60' minimum	Complies	None
Minimum lot depth	100'	Complies	None
Required front building line	<i>Between 22' & 26'</i>	from 30'-40' from Back of Curb on Montevallo Road.	This positions the West building between 22'&26' from the property line according to the Stacked Flats requirement and allows for a consistent street edge along the Montevallo frontage where the property line geometry does not match the street edge.
Front entrance extensions	An enhanced front entry may extend up to 8' beyond the constructed front building line of the building provided: (a) it occupies no more than 60% of the front façade (b) it remains unenclosed, with no fixed windows or screens. © any roof structure on or associated with is up to one and one-half stories; and (d) it is designed as an extension of the primary building using the same foundation, building materials, architectural styles, and ornamentation as the primary building.	Complies	None
Street Wall	between 65% and 100% of the street facing façade length	Complies	None
Minimum Side Setback	10% of the lot width or 10', whichever is less; except that 15' shall be required if more than 50% of the side lot line abuts a lot zoned for, or having and existing lower intensity residential use.	Complies	None
Minimum Rear Setback	20'	minimum of 20' for adjacent properties, minimum of 5'-0" for new internal property lines	Site will comply with perimeter property line setbacks to maintain existing requirements
Maximum lot coverage (footprint)	60% reduced by an additional Open Space requirement by Section 129-554 for residential uses.	Complies	None
Site access (vehicles)	Vehicle access limited according to street frontage type and as further specified in Section 129-555 (d) (1)Primary frontages. Vehicle access is prohibited except for one mid-block shared access area providing access to multiple lots within the block, and not to exceed 20 feet in width. All other vehicle access to individual lots shall be via alleys or off secondary, access, or support streets identified in the master plan.	Complies	None

8. MULTIFAMILY ZONING DATA

Multifamily Zoning (Village Overlay - Stacked Flats Building Type; Residence G)			
	BASE ZONING DISTRICT	PROPOSED PLAN	CAUSE OF DEVIATION
Mass and Height Specifications			
Maximum Height (external)	3-story: 36' to eaves/cornices plus roof structure (actual permitted stories for individual sites is controlled by the applicable Building and Development Regulating Plan)	Complies	None
Required Ground Floor Elevation	1.5' to 4' above grade at front building line	entry on high end to be 1.5' to 4' above grade at front building line	slope drops significantly across the length of building and setting high end of the building in this position will elevate low end well over the 4' cap.
1st story height	10' to 15'	Complies	None
Upper story heights (internal)	10' to 15'	Complies	None
Roof Structure heights	Steep Pitch (14:12 to 20:12) 16' maximum provided that no building shall exceed 46 feet in height Pitched roof structures may have additional floor areas which may be occupied without counting towards the story maximum for purposes of the applicable building and development regulating plan, provided the additional floor area is: (a) associated with and accessory to the floor area of the top story and (b) limited so that the areas with clear ceiling height of 7'-0" or more is no more than 50% of the floor area of the story immediately below.	maximum of 16' in roof height and maximum of 49' in building height from level 1 finished floor elevation minus distance to grade at primary entry . Occupied attic area are proposed units similar to but independent of level below with a maximum of 75% of floor area of story below.	slope drops significantly across the length of building and total height of structure will vary if measured from natural grade. All units in this develop are intended to target an empty nester demographic and, consequently re all designed as single-level living units.
Façade Specifications			
First Story Transparency	15-40%	Complies	None
Upper Story Transparency	15-40%	Complies	None
Primary Entrance	1 Enhanced Primary Entrance for each building	Complies	None
Bays	Differentiated bays are required a minimum of every 25' and a maximum of every 50'	Complies	None
Façade Projections	Bay windows and balconies may extend up to 5' from the façade	Complies	None
Building height exceptions	(2)Ornamental features. A height exception may be permitted for ornamental features on all buildings where such features do not exceed an additional six feet in height and where said feature is limited to the following: spires, chimneys, chimney pots, flag poles, and weather vanes.	Ornamental features to be limited to an additional 10'-0" in height	to best agree with the form and scale of the primary building massing
Open Space Standards	Standards. Lots shall contain public or quasi-public open space in addition to open space created implicitly by the operation of setbacks, maximum lot coverage or other building regulations. The required open space shall be based upon the type of use and building type and mass based upon the following table. The required open space shall be in addition to any required setbacks for the lot and building type, and must occur within the otherwise allowable building footprint. Open space required for townhouse or stacked flat building types may be located at any location within the otherwise allowable building footprint. Open space must be functional and should utilize the design guidelines for open space in the village master plans, but may not consist of parking areas, service areas or site utility areas. [refer to section 5.4, Open Space Design, of the Design Guidelines of the Village Master Plan for specific strategies for open space design]. Residential Uses require 100sf of open space per dwelling unit.	Complies	None

8. MULTIFAMILY ZONING DATA

Multifamily Zoning (Village Overlay - Stacked Flats Building Type; Residence G)			
	BASE ZONING DISTRICT	PROPOSED PLAN	CAUSE OF DEVIATION
Parking, vehicle, and pedestrian access standards			
Required parking	<p>By base zoning regulations (Residence G) (1)Minimum offstreet parking per dwelling unit: Two spaces.</p> <p>a.Exception: Projects over 20 dwelling units, and which may have a substantial mix of dwelling units which could be designed for families with fewer than two vehicles may propose an alternative parking ratio. The proposal for a reduced rate shall be based on demonstrated and convincing market and demographic data regarding the parking demand per each dwelling type included in the mix. Approval of an alternative ratio is in the sole discretion of the city council, based on a recommendation of the planning commission.(2)Visitor and accessory parking shall be provided based on the following:</p> <p>Eleven or more units: Five spaces plus one-fourth additional parking space for each unit over ten;</p> <p>(3)Any offstreet surface parking, interior parking or parking structures for the dwelling units and for visitor or accessory parking shall meet the parking design and vehicle access limitations of the village overlay standards.</p>	1.5 stalls per unit	<p>Parking is in line with market rate product and above the market based on the target demographic. Parking beneath building is intended to completely meet the requirements for the residential units. 16 units / 24 parking stalls = 1.5 stalls / unit. The street parking would serve as visitor parking. Per base zoning, 5+5.5 = 10.5 stalls required, 13 stalls provided.</p>
Vehicle access limitations	<p>Vehicle access to all lots subject to the village overlay standards shall be limited according to frontage type indicated on the applicable building and development regulating plan based upon the following standards:(1)Primary frontages. Vehicle access is prohibited except for one mid-block shared access area providing access to multiple lots within the block, and not to exceed 20 feet in width. All other vehicle access to individual lots shall be via alleys or off secondary, access, or support streets identified in the master plan.</p>	Complies	None
Sidewalk standards	<p>Any development fronting on streets that do not currently have sidewalks shall include sidewalks in association with the site development according to the following:(1)Sidewalks on primary village street designated in the Circulation and Urban Design Plan of the Village Master Plan, adopted June 2007, shall be between eight-foot and 12-foot wide.</p>	Complies	None
Material specifications		See Pattern Book	

SINGLE-FAMILY ZONING (RESIDENTIAL INFILL DISTRICT BASE)			
	BASE ZONING DISTRICT	PROPOSED PLAN	CAUSE OF DEVIATION
Purpose	The residential infill district is an "overlay" district that is designed to promote the highest and best use of residential real estate by permitting the cost-effective development or redevelopment of residential property in limited areas within the city, under carefully controlled conditions, and in ways that will serve the purpose of the zoning ordinance without compromising the unique character of the residential districts within the city. (1)To permit additional, high-quality residential land use and development options for "transitional" zones between existing commercial and/or business uses and residential districts, the effect of which would be to maintain the residential character of existing residential districts while simultaneously discouraging objectionable nonresidential encroachment into such districts;	Complies	None
Permitted Uses	(a) Detached single-family dwellings. (b) Accessory structures; accessory buildings customarily incidental to residential occupancy; provided, that no accessory building may be used as a dwelling, or occupied by any person, either on a long-term or temporary basis; further provided, that such prohibition shall not apply to any accessory building which was designed for human habitation and was in existence or in the process of construction on June 28, 1993; (c) Gardens and greenhouses customarily incidental to residential occupancy; provided, that the products grown there may not be sold on the premises.	Complies	None
Area & dimensional requirements			
Max. Density	Regarding the development taken as a whole, the average lot size shall be 6,000 square feet of land area; however, the city may require lower densities to achieve compatibility with the nature, density, and character of surrounding property.	Complies	None
Minimum Yards	(c) Minimum yards, setbacks, and building separation: No structure shall be located closer than ten feet from any adjacent residential property; provided, however, that the city may require additional setback area, buffers, greenbelts, or other landscape feature to achieve compatibility with the nature, density, and character of surrounding property. All buildings shall be located so as to conform to the Southern Standard Building Code and the Standard Fire Prevention Code, both as may be adopted and amended by the city.	Minimum setbacks will be 5' from lot lines, which would provide a minimum of 10' between buildings	In order to present a more urban and compact street , the lots and setbacks will be reduced
Min. Lot Frontage	(d)Minimum lot frontage on a public street: None; however, all lots shall either adjoin a public street or have access to a public street via a recorded easement or a private right-of-way.	Complies	None
Max Building Ht.	(e)Maximum building height: Two and one-half stories or 37½ feet, provided that a lower building height may be mandated in order to achieve the purposes of this article.	Complies	None
Streets	All proposed public streets and improvements shall meet or exceed the minimum standards established by the Mountain Brook subdivision regulations. The city shall determine whether private streets or roadways are appropriate for the proposed development, based upon its master development plan review, considering the size of the development, density, relationship to the surrounding area, and public safety.	On site streets would be private but built to meet City of Mountain Brook emergency access requirements. On site alleys would be private and not intended for city access / use.	The primary vehicular court is envisioned to be a plaza and covered in a decorative / patterned paver in order to meet the aesthetic goals of the development. This material is traffic-rated but non-standard for a street surface and the maintenance and ownership would sensibly be the burden of the HOA.
Off street Parking	Driveways, parking areas, and related improvements shall be privately owned. Convenient offstreet parking shall be provided for all dwelling units. All parking spaces, driveways, and other areas necessary for the maneuvering of motor vehicles shall be arranged so as to provide convenient access to a paved street or alley. Sidewalks, parking spaces, driveways, and maneuvering areas shall be paved and shall have adequate storm drainage facilities. All driveways, parking areas, and steps shall be adequately lighted.	Complies	None
Additional Requirements	(a)Utilities. All utility lines shall be placed underground.	Complies	None
	(b)Fire protection. All buildings or structures must be located no farther from a fire hydrant than may be reached with 500 feet of hose.	Complies	None
	(c)Separate ownership. Each dwelling shall be situated on a separate lot, unless the development is a condominium which use shall be permitted in the residential infill district.	Complies	None
	(d)Title to property. All common areas, such as private streets, driveways, parks, recreational facilities, planted or forested areas, and all other improved or unimproved real property and improvements shall be privately owned, and title thereto may be held by a trustee for the benefit of the residents of such development, by a private corporation, by an association of the residents thereof, or as undivided interests owned by the owners of the lots within such development. Such trustee, corporation, association, or owners (jointly and severally) shall be responsible for the proper care and maintenance of such streets and other property and improvements.	Complies	None
	(e)Documentation of maintenance of improvements. Prior to final plat approval of a subdivision for a residential infill development, the developer shall submit to the city clerk appropriate legal documents that provide for adequate maintenance of private streets and driveways, parks, recreational facilities, planted or forested areas, and all other improved or unimproved real property and improvements located within the common areas.	Complies	None

this page intentionally left blank

9. PATTERN BOOK

MULTIFAMILY USE ZONE

Lot Layout notes:

- see zoning comparisons for lot layout requirements.

SINGLE FAMILY USE ZONE

Lot Layout notes:

- see zoning comparisons for lot layout requirements.
- There is no minimum or maximum required lot depth.
- There is no minimum or maximum required lot width.
- Maximum lot coverage is 65% of the buildable area. Pedestrian and vehicular circulation shall not count against the lot coverage.
- Side setbacks between buildings are a minimum of 10' (5' each side of property line), provided building code separation requirements are met.
- All references to a lot or depictions of a lot line shall refer to a Parcel or the boundary line of such Parcel.
- Lot layout example is shown for design intent and does not represent a prescriptive answer for the building design. Building designs will be the responsibility of the lot owner.

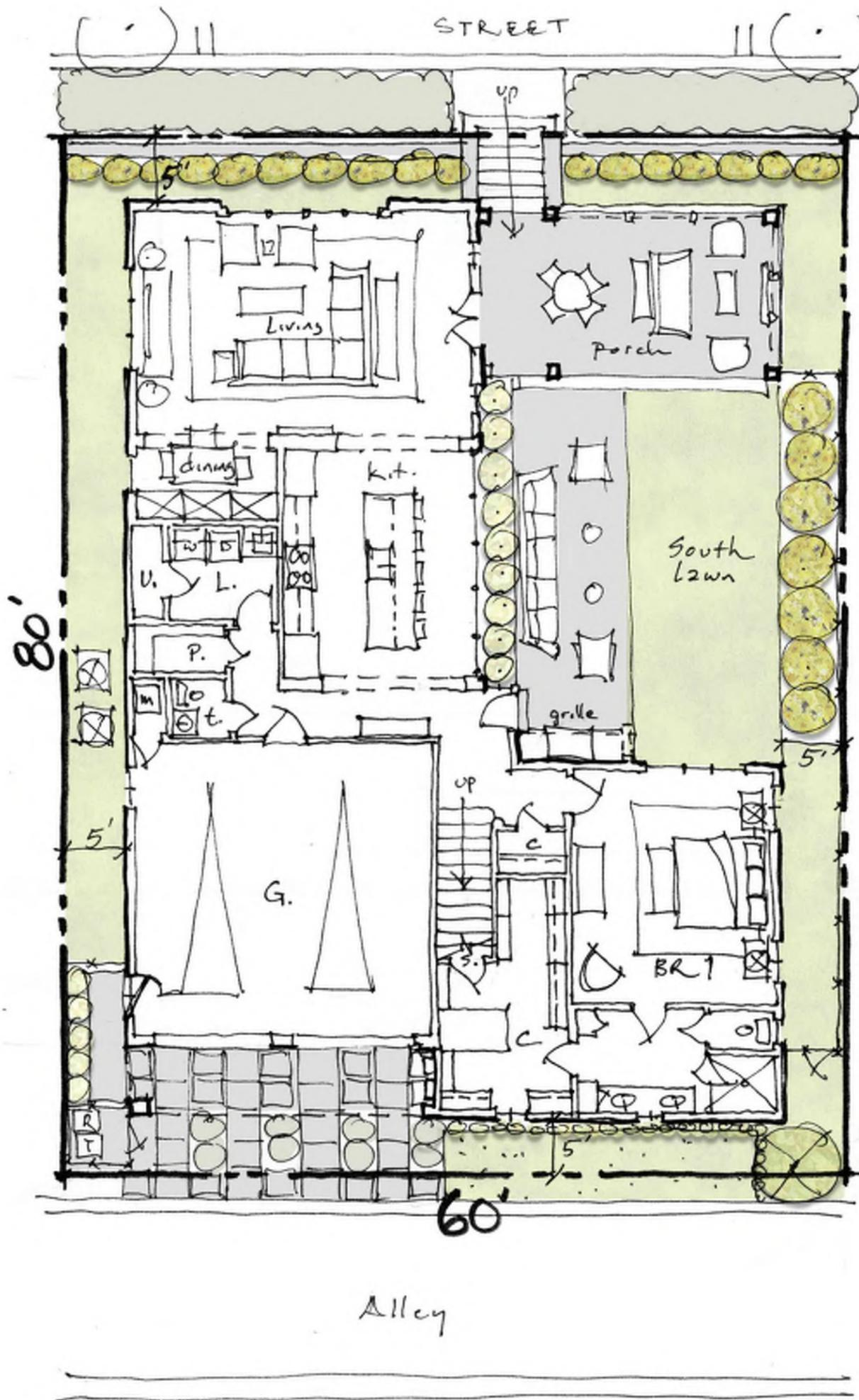

9. PATTERN BOOK

ARCHITECTURAL STYLES

The British Arts & Crafts Movement:

The British Arts and Crafts Movement- (1880-1920)- it was a revolution in the decorative and fine arts that focused on clean, simple lines in architecture, furniture and other decorative arts. It centered around a belief in craftsmanship, the inherent beauty of a material, importance of nature as inspiration, and the value of simplicity, utility and beauty.

Started by Augustus Pugin, William Morris and John Ruskin.

Notable Architects include C.F.A. Voysey, Edwin Lutyens, M.H. Baillie Scott, Charles Rennie Mackintosh to name a few.

Most Common: The English Farmhouse/Cottage

- These houses were influenced and inspired by English vernacular sources of the 16th and 17th centuries (i.e. the English Farmhouse). They used simple palettes of local materials:
- British Arts and Crafts was based on elements of vernacular architecture: white washed walls, steep slate roofs, sandstone mullions and double chimney stacks. All evoke Lakeland farmhouse architecture of the 16th and 17th centuries.
- Most Exterior walls are red masonry brick, stone or roughcast (heavy textured stucco)
- Roof were predominantly steep pitched and used clay or slate tile roofs
- Windows were predominantly steel and often ganged together in horizontal ribbons with stone surrounds.
- Emphasis on natural materials, honest use and connection back to nature.



9. PATTERN BOOK

ARCHITECTURAL STYLES

The British Arts & Crafts Movement:

Key Exterior Elements:

- Steep Roofs with smaller projected hipped or shed roofs
- Exposed roof rafter tails
- Simplified decorative beams or brackets under gables
- Tapered Buttresses
- Horizontal shape
- Ganged exterior windows/corner windows (Emphasize the horizontal)
- Punched windows
- Equally divided window lites
- Porch support bases extending to ground level
- Wood, stone or stucco siding
- Exterior brick, stucco(roughcast) and stone combinations
- Earth-tone exterior paint and stain colors



9. PATTERN BOOK

ARCHITECTURAL STYLES

The British Arts & Crafts Movement:

Exterior Materials:

- British A&C Houses typically have exteriors with
- Lime washed stone or brick masonry,
- Stone masonry with brick accents or roughcast stucco.
- Gable ends and infill areas at windows or doors are horizontal wood T&G.
- Chimney flues are typically stucco over masonry, stone or brick masonry with simple cap (or corbelling) with clay chimney pots.
- Roofing materials can be clay tile, wood shake roofing, copper soldered flat seam roofing or slate.



9. PATTERN BOOK

ARCHITECTURAL STYLES

The British Arts & Crafts Movement:

Exterior Windows:

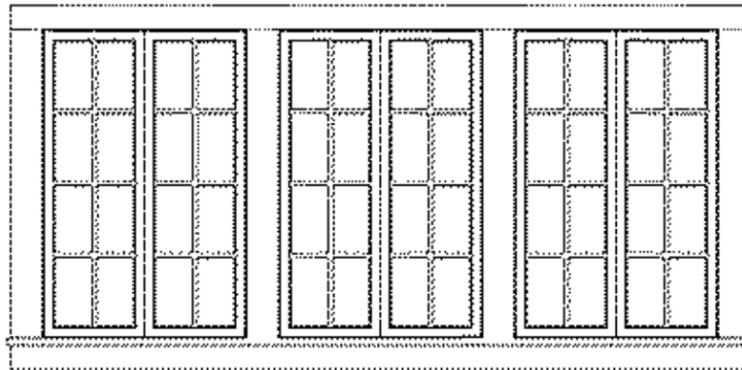
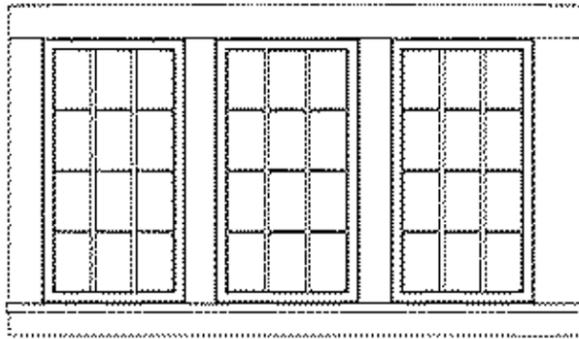
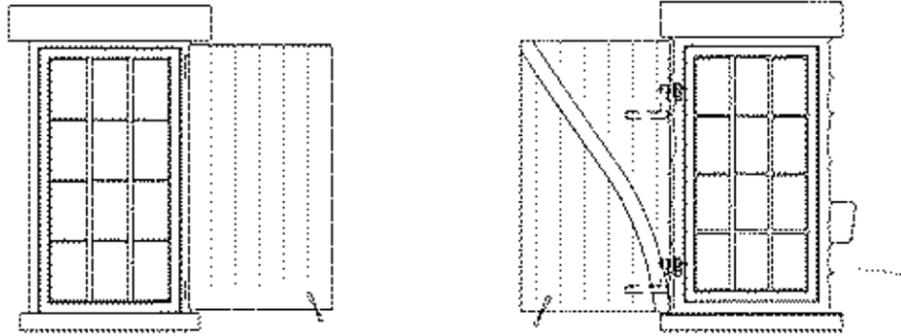

9. PATTERN BOOK

ARCHITECTURAL STYLES

The British Arts & Crafts Movement:

Exterior Doors:



Organic

Median

Refined

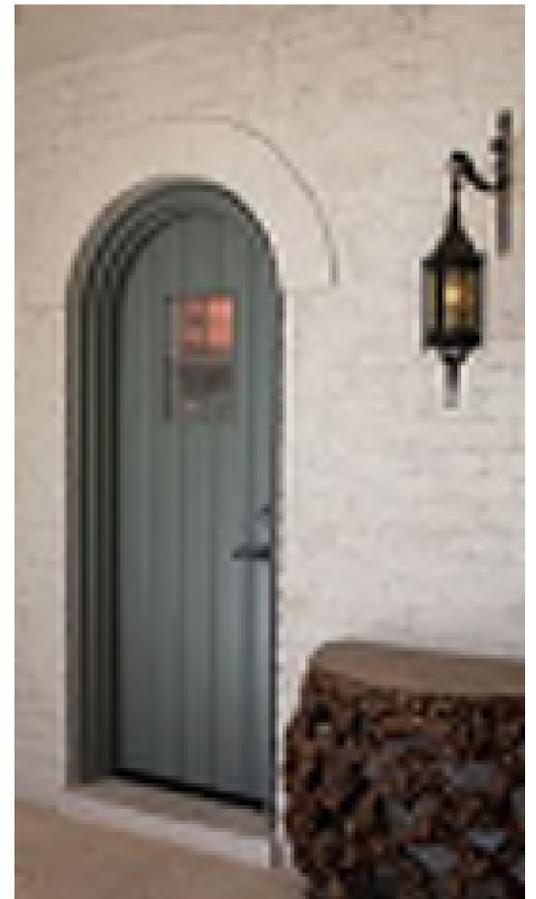

9. PATTERN BOOK

ARCHITECTURAL STYLES

The British Arts & Crafts Movement:

Exterior Porches and Brackets:

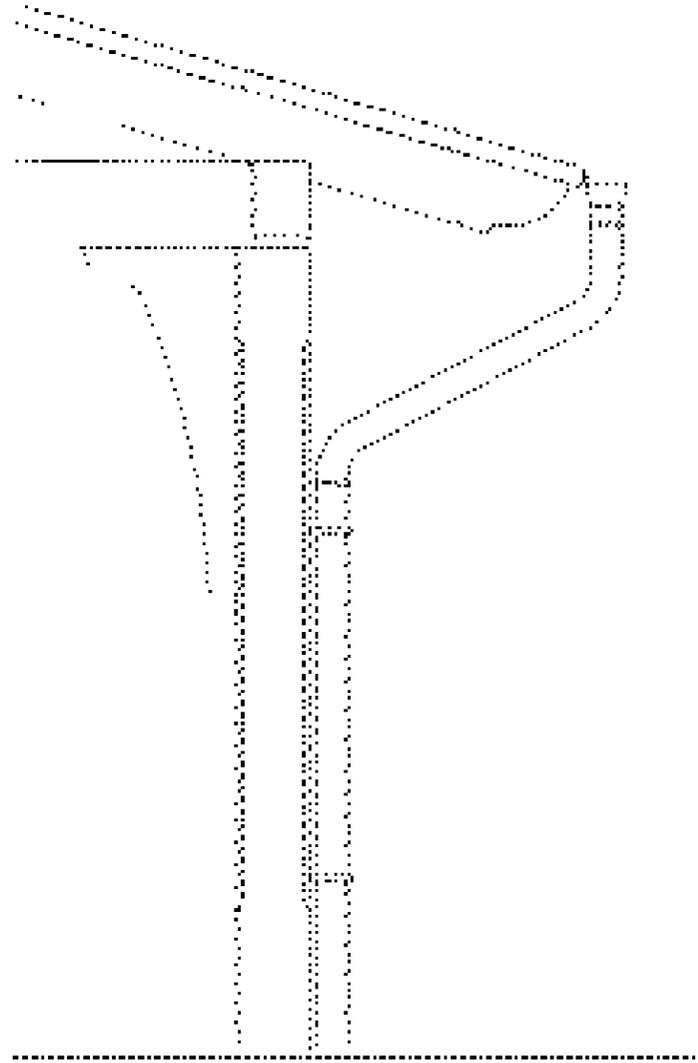
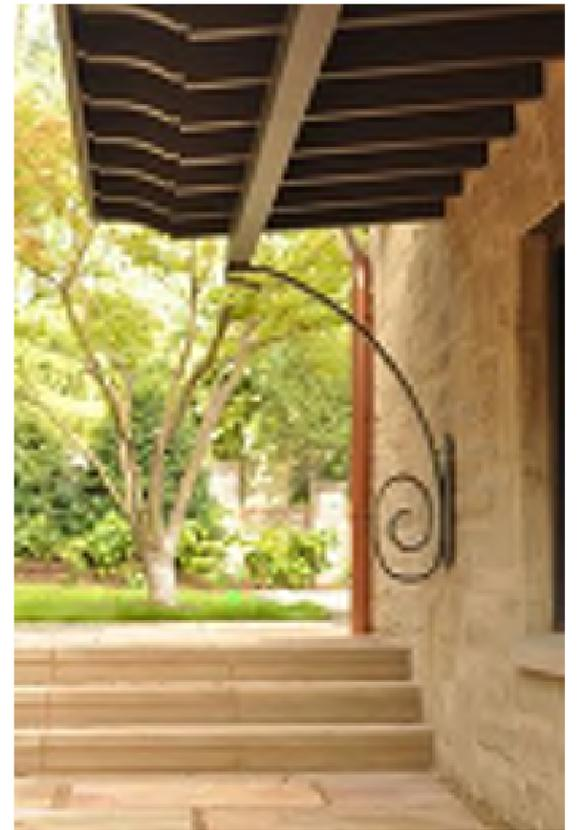
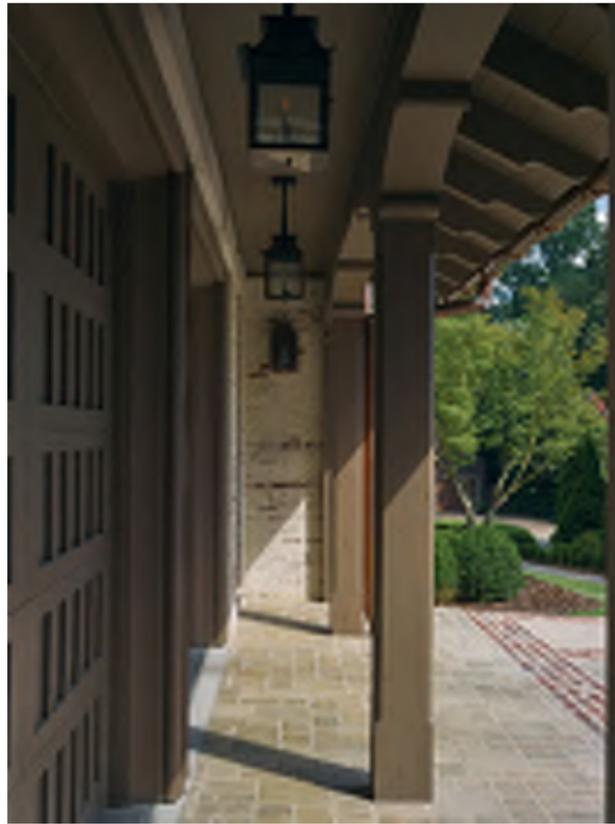

9. PATTERN BOOK

ARCHITECTURAL STYLES

The British Arts & Crafts Movement:

Roughcast & Piers:

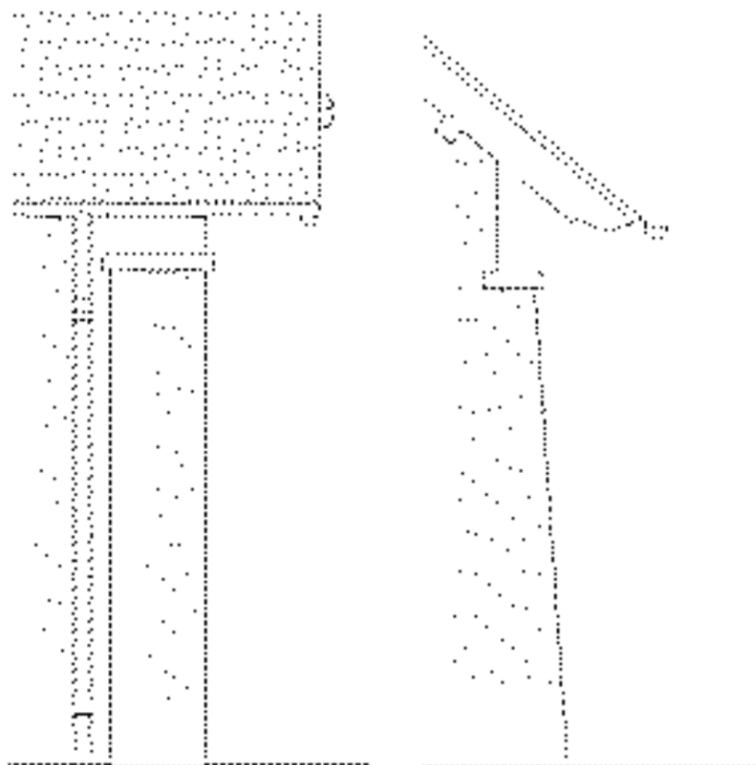

9. PATTERN BOOK

ARCHITECTURAL STYLES

The British Arts & Crafts Movement:

Dormers:

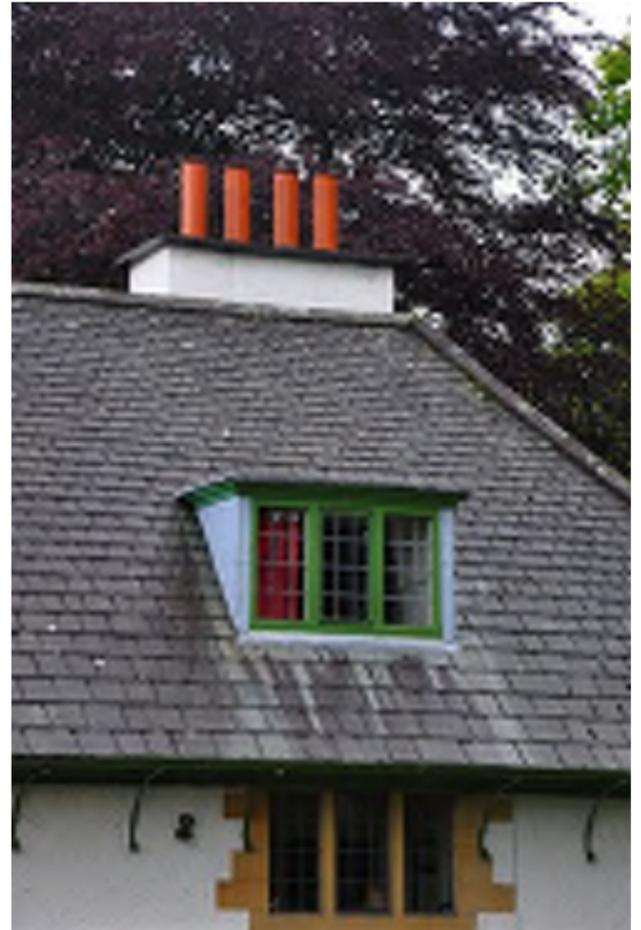

9. PATTERN BOOK

ARCHITECTURAL STYLES

The British Arts & Crafts Movement:

Exterior Lighting:



9. PATTERN BOOK

ARCHITECTURAL STYLES

The English Tudor Revival Style:

English Tudor Revival Style- Tudor Revival architecture first manifested itself in domestic architecture in the United Kingdom in the latter half of the 19th century. Based on revival of aspects that were perceived as Tudor architecture, in reality it usually took the style of English vernacular architecture of the Middle Ages that had survived into the Tudor period. The style later became an influence elsewhere, especially the British colonies. It was associated with the Arts and Crafts movement.

Largely forgotten for three centuries, the Tudor style reappeared in the United States in the early 1900s but built using the same wood-framing methods used to construct other homes of the era. Americans embraced the Tudor style, building new homes that blended some of the old-world design elements with modern home-building techniques. The Tudor Revival Style has many alternate labels: Elizabethan, Jacobean, Queene Anne & Cotswold.

Cousins of the Stick-style house, Tudor Revivals eschewed authentic half-timber construction and often featured brick or stone walls on the first story, and upper floors that were stud-framed and covered with a veneer of stucco and decorative faux timbers. Cross gables were commonly included in the plans, as were typically Tudor features like steep rooflines and gabled windows with leaded-glass mullions. The traditional thatched roof, however, was replaced by slate. They typically had clustered chimney stacks of stone and brick. Interiors incorporated such Tudor-style elements as decorative beamed ceilings, arched doorways, plaster walls, and detailed wooden staircase.

Common Characteristics:

- Decorative Half-Timbering
- Use of Mixed Building Materials
- Large Groupings of Windows
- Attention to Detail in the Entrance
- Steeply pitched roofs and multiple gables.
- Two or three stories high.
- Rectangular design.
- Half-timbered exterior façade used in conjunction with stucco or decorative brickwork.
- Cantilevered (overhanging) second story extending over a large porch.
- Tall windows with multiple square- or diamond-shaped panes; some are leaded glass.
- Tall ornate brick chimneys.
- Chunky iron door ware that lends a Medieval look.
- Earth-tone cladding colors (tan, brown, buff).
- Asymmetrical floor plans.
- Interiors with (faux) exposed ceiling beams overhead.
- Oversized, stained wood detailing, including wainscoting and trim.
- Jetties, or overhangs formed when the second floor extends beyond the dimensions of the first (a feature made popular in cities where the first-floor footprint was limited by the street outside.)

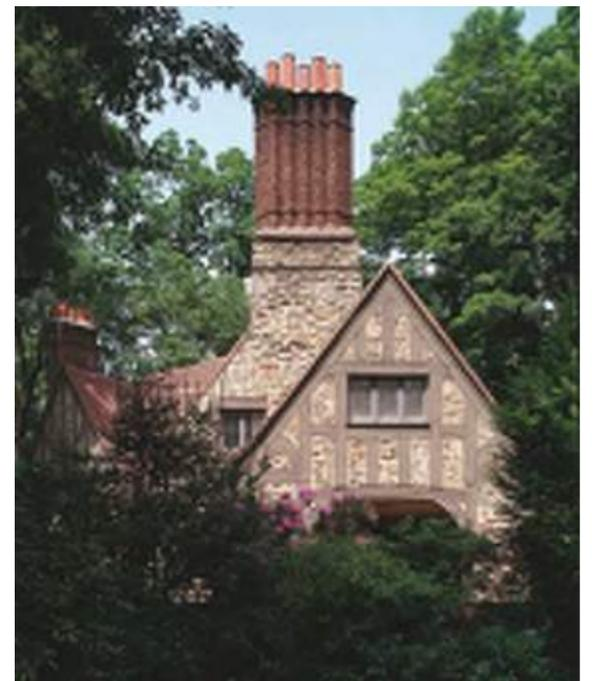

9. PATTERN BOOK

ARCHITECTURAL STYLES

The English Tudor Revival Style:

Key Exterior Elements:

- Low pitched, gabled secondary roof forms (occasionally hipped) with wide unenclosed eave overhang
- Exposed roof rafter tails
- Simplified decorative beams or brackets under gables
- One and half stories for entry porches and secondary volumes
- Horizontal shape
- Porch with thick square or tapered columns
- Porch support bases extending to ground level
- Wood, stone or stucco siding
- Chimney expressed on the exterior wall
- Earth-tone exterior paint and stain colors



9. PATTERN BOOK

ARCHITECTURAL STYLES

The English Tudor Revival Style:

Chimneys:

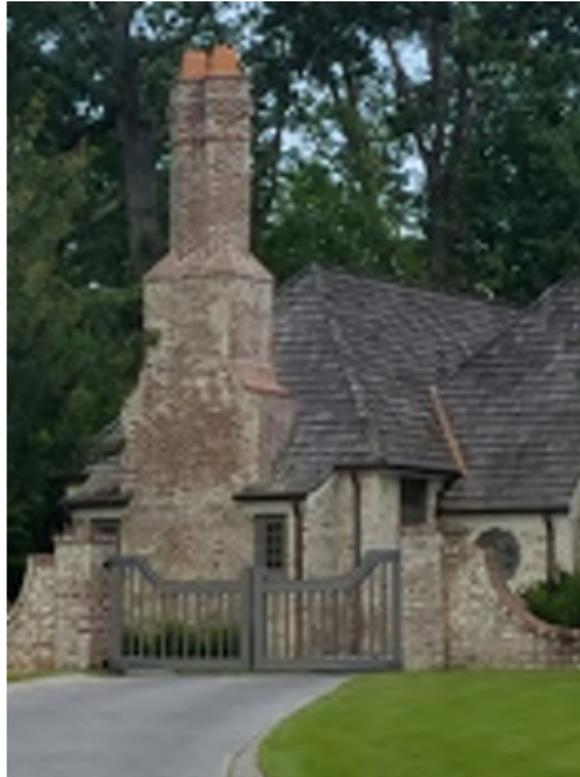

Exterior windows:

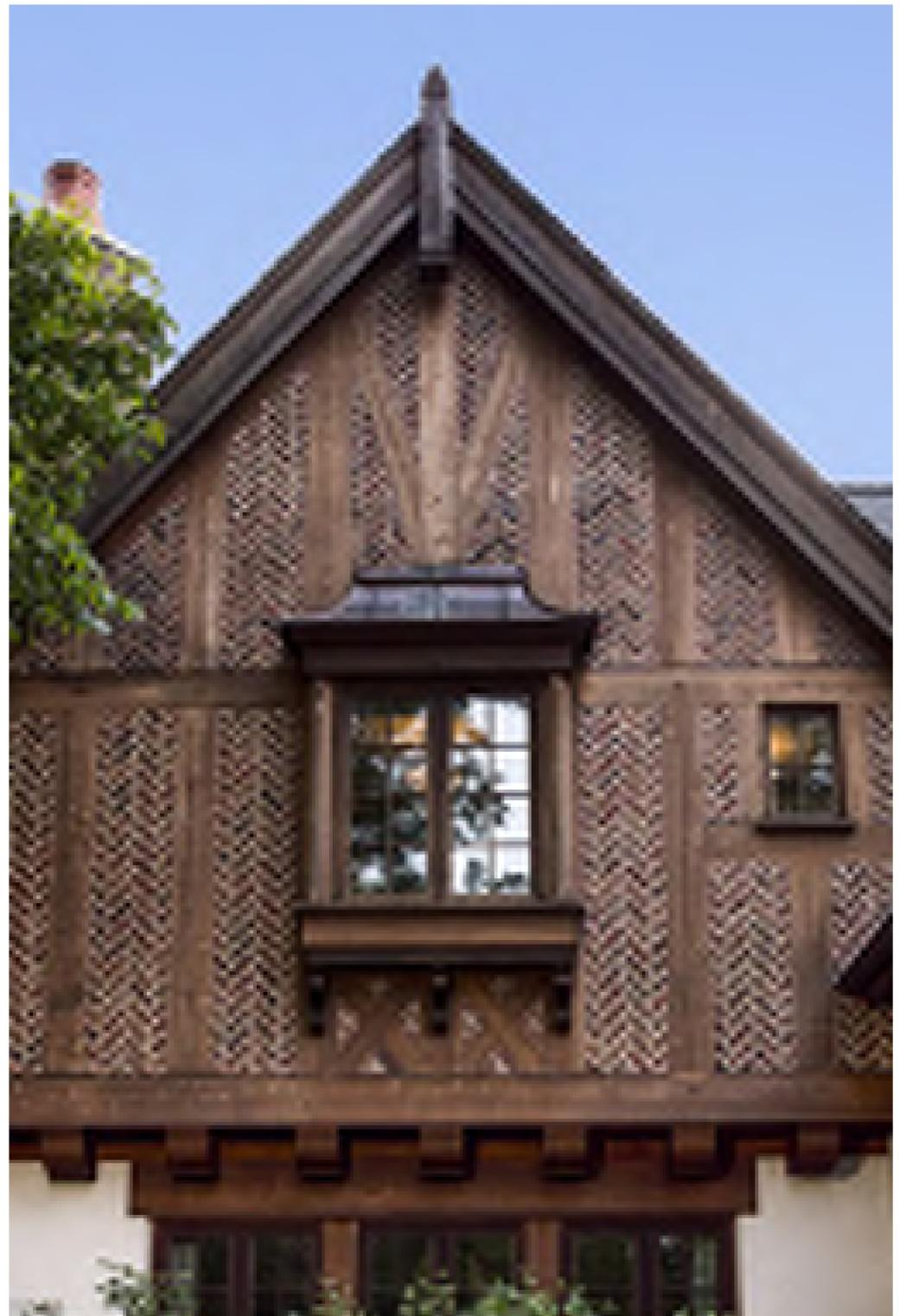

9. PATTERN BOOK

ARCHITECTURAL STYLES

The English Tudor Revival Style:

Exterior Windows:

Organic



Median

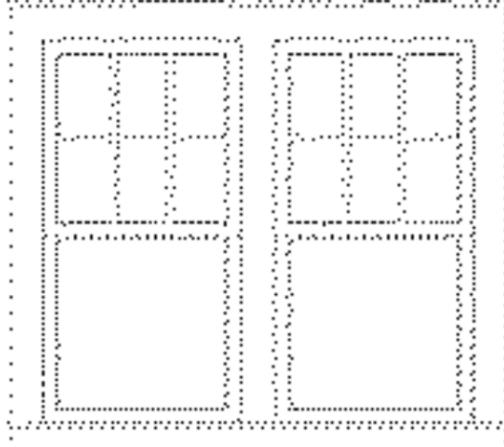

Refined



Exterior Doors:

Organic



Median



Refined

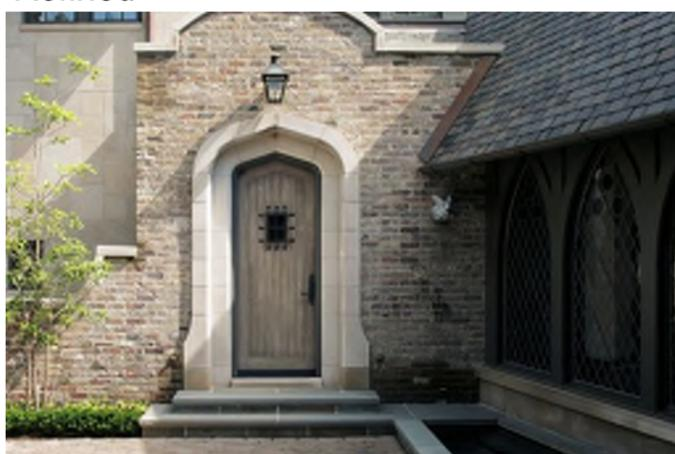

9. PATTERN BOOK

ARCHITECTURAL STYLES

The English Tudor Revival Style:

Exterior Porches and Brackets:



9. PATTERN BOOK

ARCHITECTURAL STYLES

The English Tudor Revival Style:

Exterior Lighting:



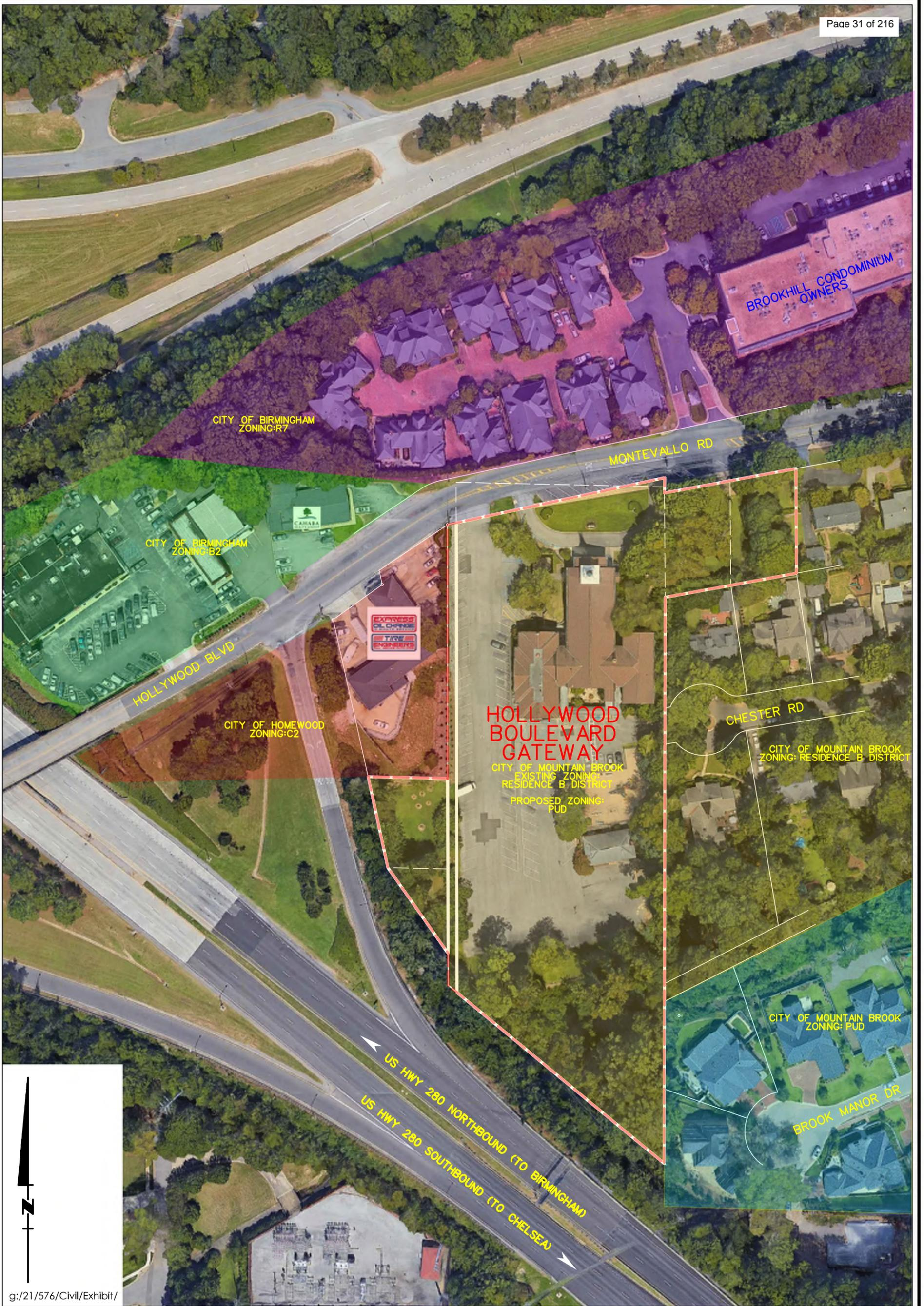

g:/21/576/Civil/Exhibit/

VICINITY MAP

HOLLYWOOD BOULEVARD GATEWAY

DATE: JUNE 09, 2022
 SCALE: 1"=60'

Copyright © 2022 School Engineering Company, Inc.

Civil Engineering | Land Surveying | Landscape Architecture
 Environmental | Water Resources | Laser Scanning + Modeling



1001 22nd Street South | 7500 Memorial Pkwy SW, Ste 209
 Birmingham, Alabama 35205 | Huntsville, Alabama 35802
 205.323.6166 | 256.539.1221

SCHOEL.COM

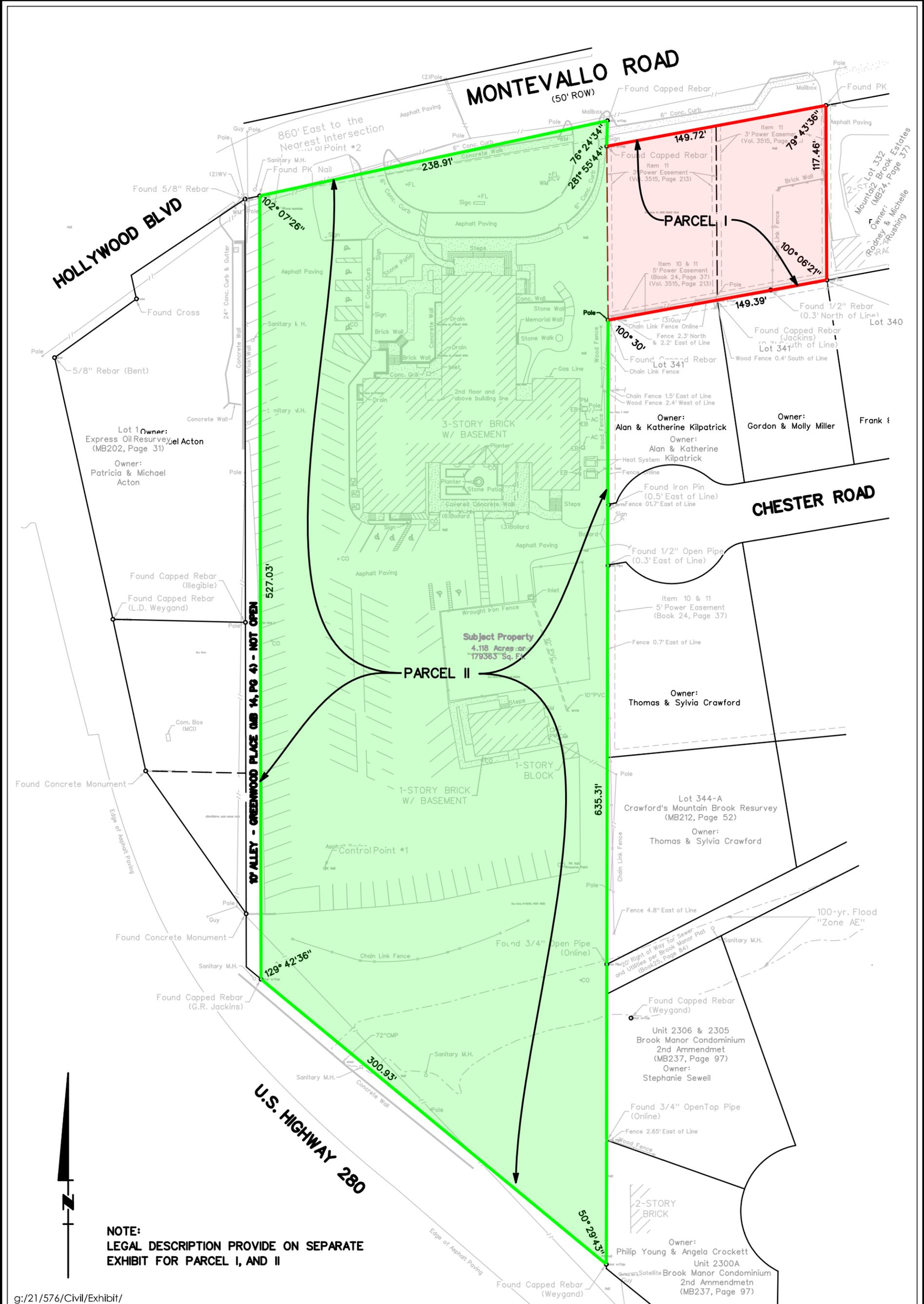

NOTE:
 LEGAL DESCRIPTION PROVIDE ON SEPARATE
 EXHIBIT FOR PARCEL I, AND II

g:/21/576/Civil/Exhibit/

PERIMETER SURVEY

HOLLYWOOD BOULEVARD GATEWAY

DATE: AUGUST 19, 2022
 SCALE: 1"=60'

Civil Engineering | Land Surveying | Landscape Architecture
 Environmental | Water Resources | Laser Scanning + Modeling



1001 22nd Street South | 7500 Memorial Pkwy SW, Ste 209
 Birmingham, Alabama 35205 | Huntsville, Alabama 35802
 205.323.6166 | 256.539.1221

SCHOEL.COM

-  COBBLE STONE HARDSCAPE
-  ASPHALT PAVING
-  CONCRETE DRIVEWAY
-  CONCRETE SIDEWALK

HATCHED AREA IS NOT IN THE CITY OF MOUNTAIN BROOK AND IS NOT INCLUDED AS A PART OF THIS ZONING REQUEST. THIS AREA IS INTENDED TO BE DEVELOPED AS A PART OF THIS PROJECT AFTER APPROPRIATE APPROVALS BY THE AUTHORITY HAVING JURISDICTION.

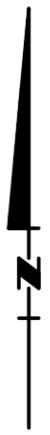
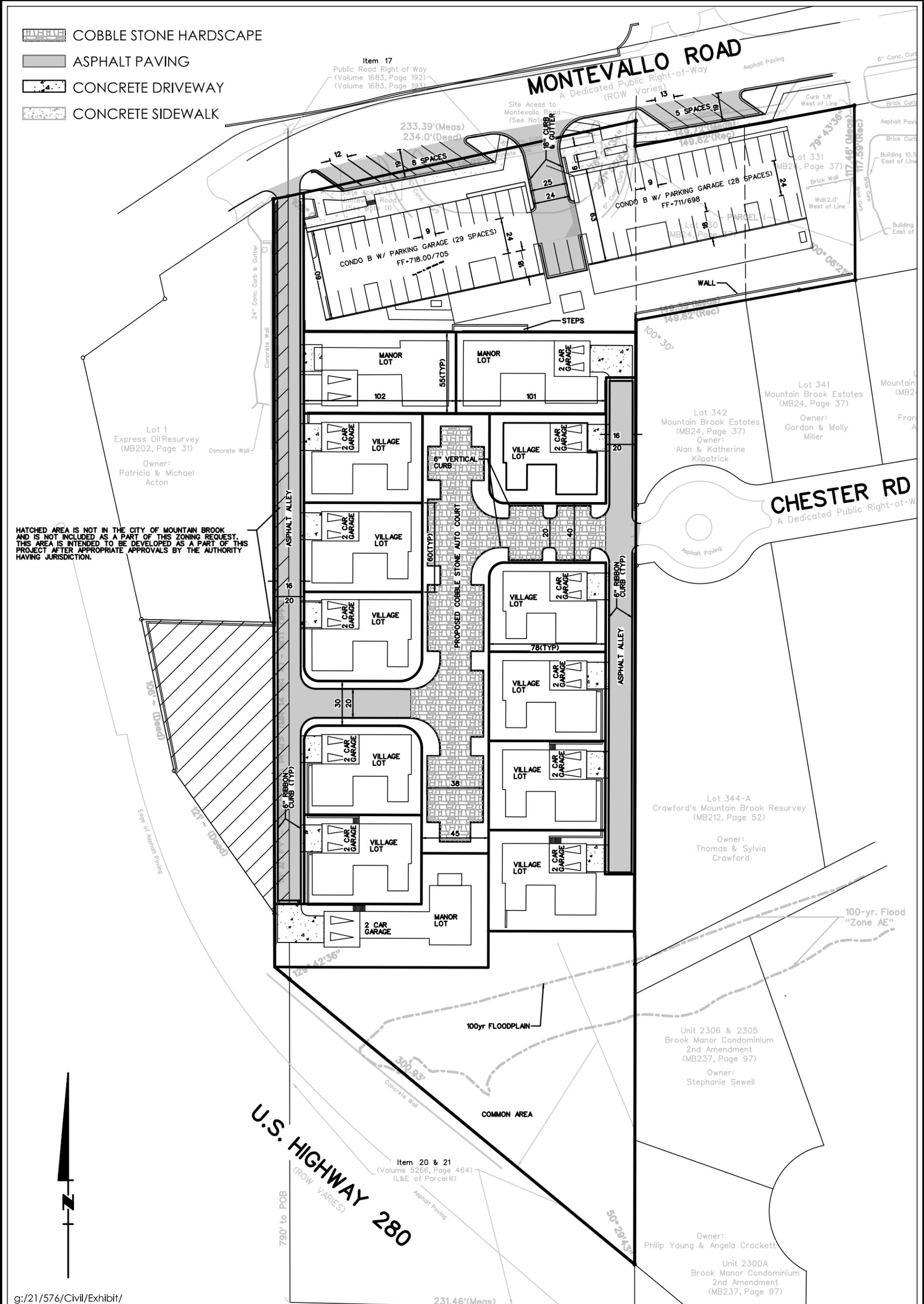

g:/21/576/Civil/Exhibit/

SITE LAYOUT PLAN HOLLYWOOD BOULEVARD GATEWAY

DATE: AUGUST 26, 2022
SCALE: 1"=60'

Civil Engineering | Land Surveying | Landscape Architecture
Environmental | Water Resources | Laser Scanning + Modeling



1001 22nd Street South | 7500 Memorial Pkwy SW, Ste 209
Birmingham, Alabama 35205 | Huntsville, Alabama 35802
205.323.6166 | 256.539.1221

SCHOEL.COM

13. LEGAL DESCRIPTIONS

LEGAL DESCRIPTIONS

PARCEL I:

Lots 330 and 331, according to the Survey of Mountain Brook Estates, Chester Road, as recorded in Map Book 24, page 37, in the Probate Office of Jefferson County, Alabama.

+/- 17,256 Square Feet or 0.4 Acres

PARCEL II:

Begin at the center of the North boundary line of the NW 1/4 of the SW 1/4 of Section 8, Township 18, Range 2 West; thence run South along the center line of said NW 1/4 of SW 1/4 790 feet; thence East and parallel with the North boundary line of the said NW 1/4 of SW 1/4 234 feet; thence North 790 feet to the North boundary line of said 40 acre tract; thence West along the said North boundary line 234 feet to Point of Beginning.

LESS AND EXCEPT any portion of subject property lying US Highway 280. Situated in Jefferson County, Alabama.

+/- 151,035.66 Square Feet or 3.5 Acres

g:/21/576/Civil/Exhibit/

SURVEY LEGAL DESCRIPTIONS HOLLYWOOD BOULEVARD GATEWAY

DATE: JUNE 09, 2022
SCALE: 1"=60'

Copyright © 2022 Schoel Engineering Company, Inc.

Civil Engineering | Land Surveying | Landscape Architecture
Environmental | Water Resources | Laser Scanning + Modeling

SCHOEL

1001 22nd Street South | 7500 Memorial Pkwy SW, Ste 209
Birmingham, Alabama 35205 | Huntsville, Alabama 35802
205.323.6166 | 256.539.1221

SCHOEL.COM

14. APPENDICES

APPENDIX B
RENDERINGS



HOLLYWOOD BOULEVARD GATEWAY LOOKING EAST



MONTEVALLO ROAD LOOKING WEST



WEST ELEVATION OF CONDO A

APPENDIX G
CONDOMINIUM PLANS AND ELEVATIONS

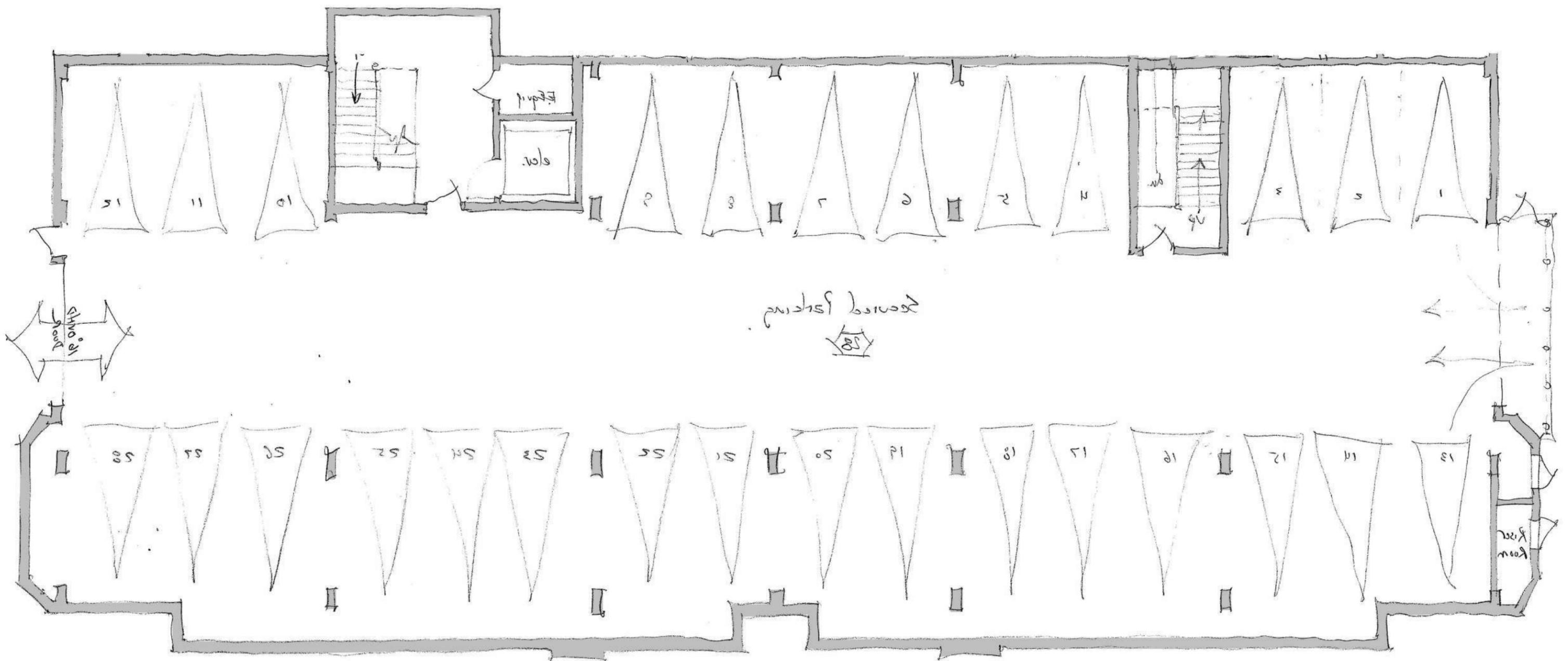

CONDO A BASEMENT LEVEL PLAN
NTS

MONTEVALLO ROAD

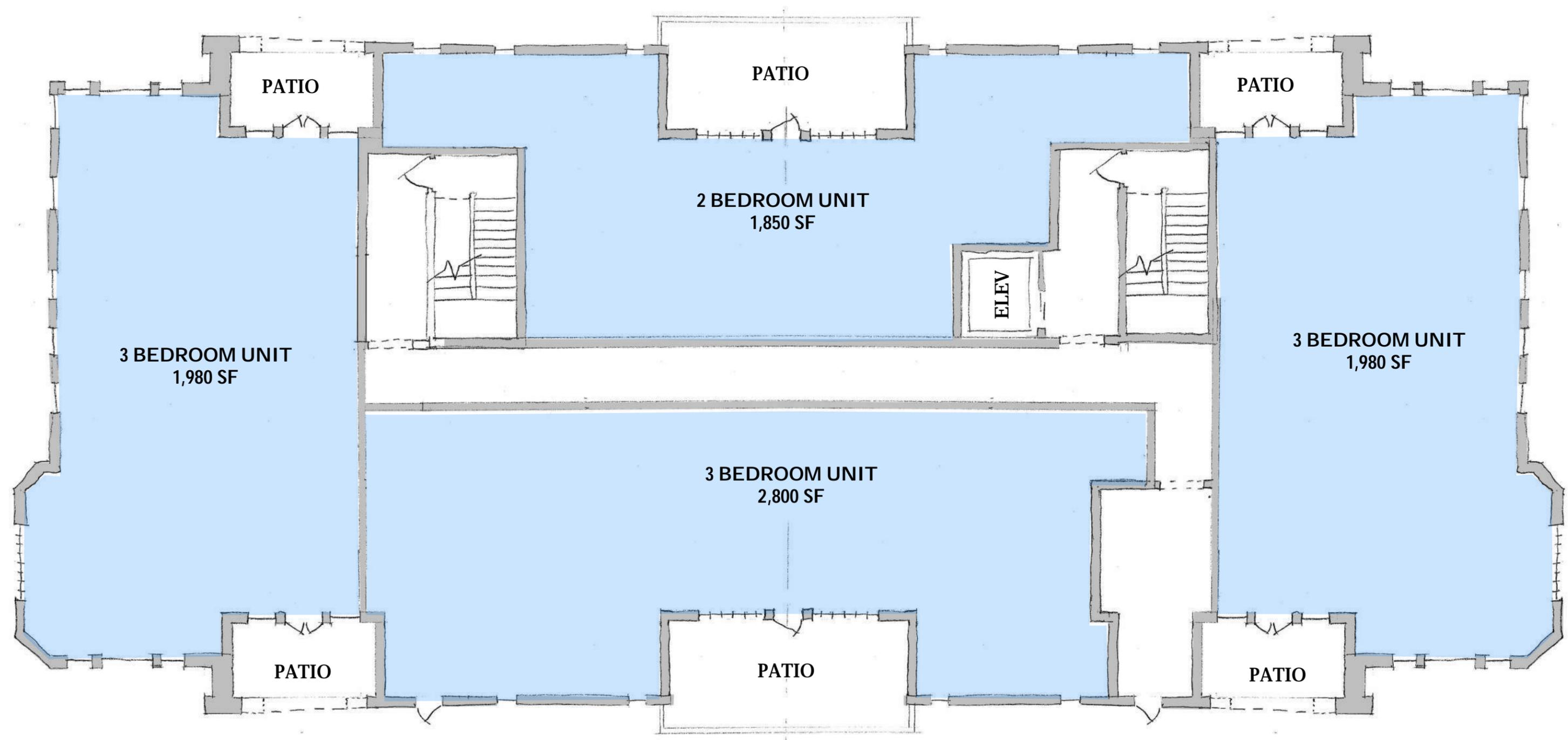

CONDO A LEVEL ONE PLAN
NTS

MONTEVALLO ROAD

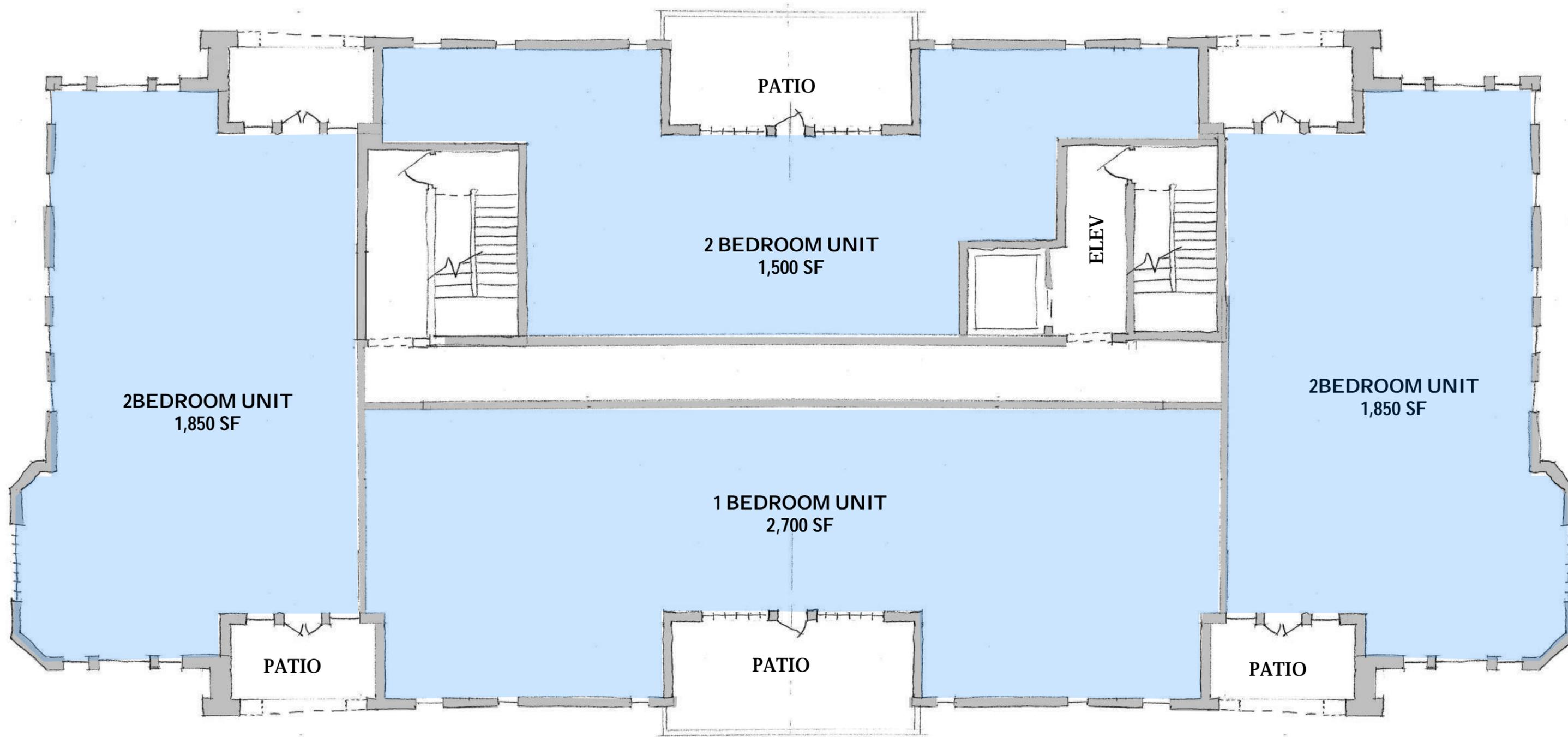

CONDO A LEVEL TWO/THREE PLAN
NTS

MONTEVALLO ROAD

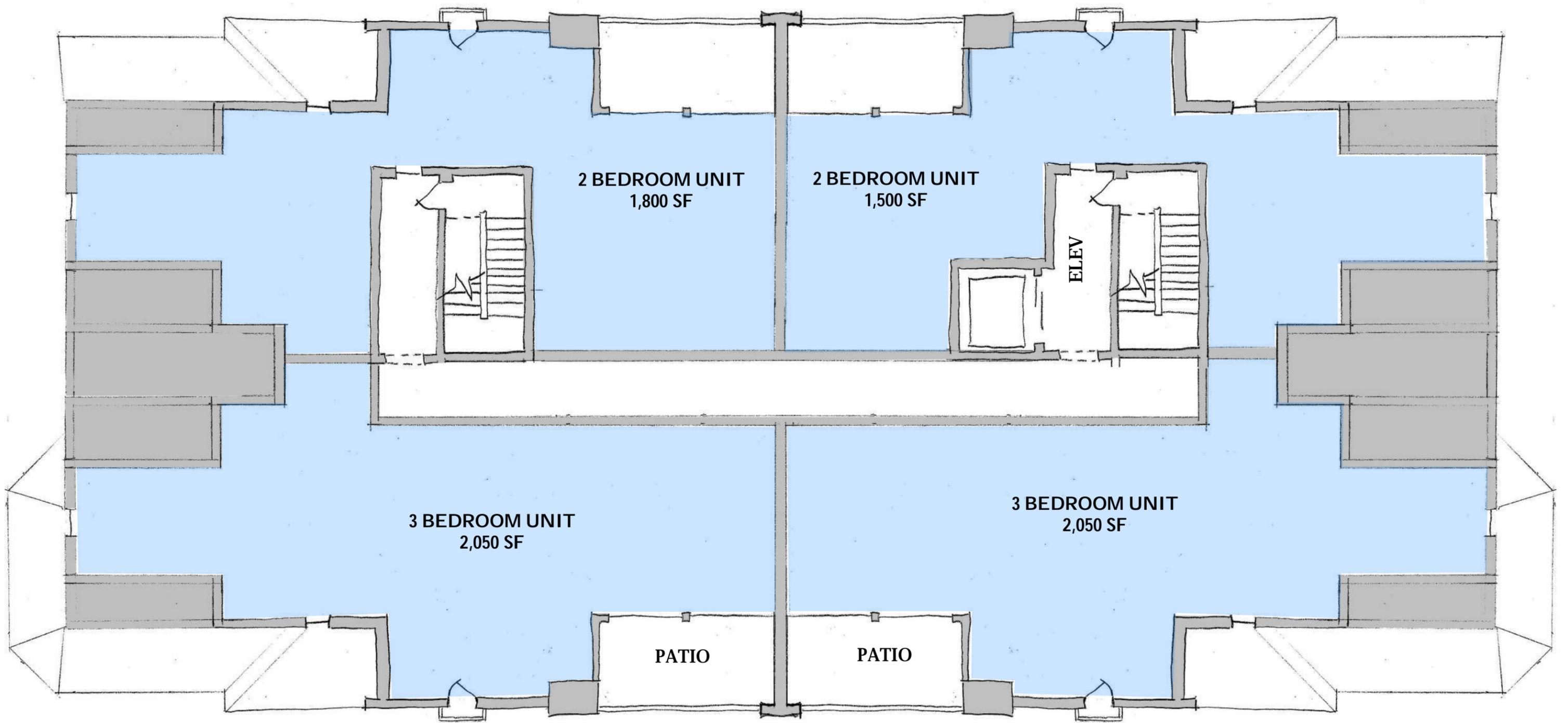

CONDO A ATTIC LEVEL PLAN
NTS

MONTEVALLO ROAD



CONDO A MONTEVALLO ROAD ELEVATION
NTS



CONDO A WEST ELEVATION
NTS



CONDO A EAST ELEVATION
NTS



CONDO A SOUTH ELEVATION
NTS

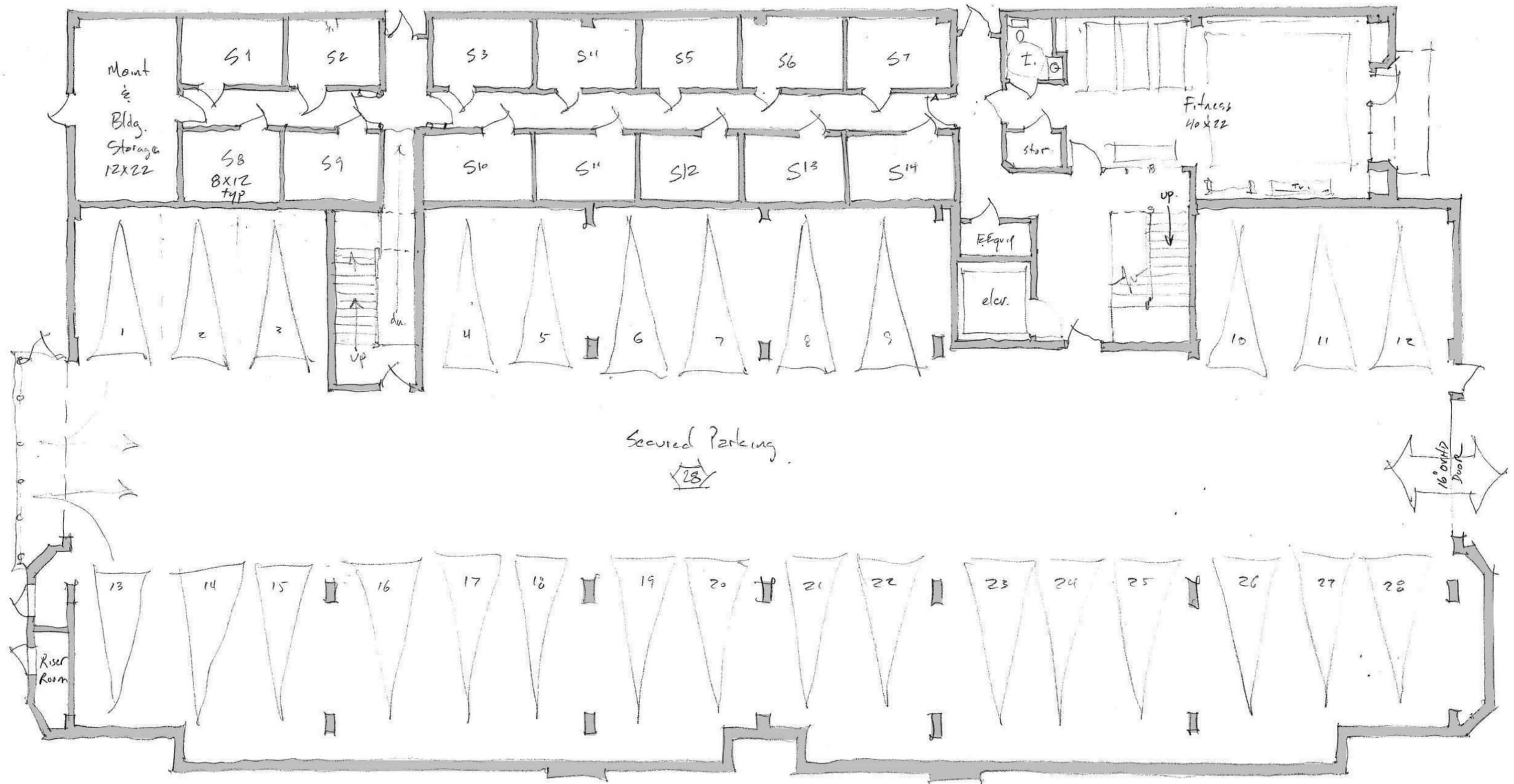

CONDO B BASEMENT LEVEL PLAN
NTS

MONTEVALLO ROAD

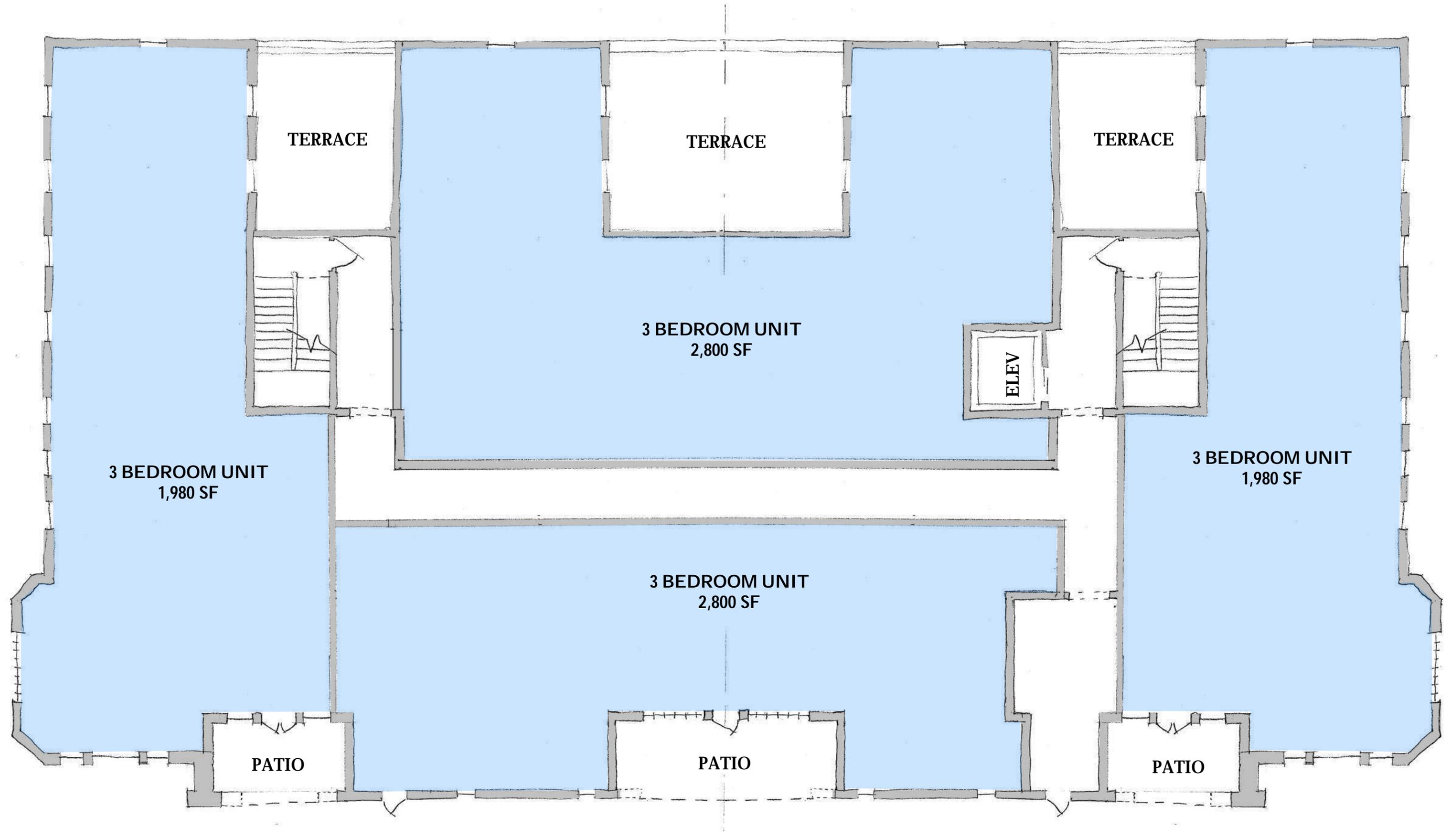

CONDO B LEVEL ONE PLAN
NTS

MONTEVALLO ROAD

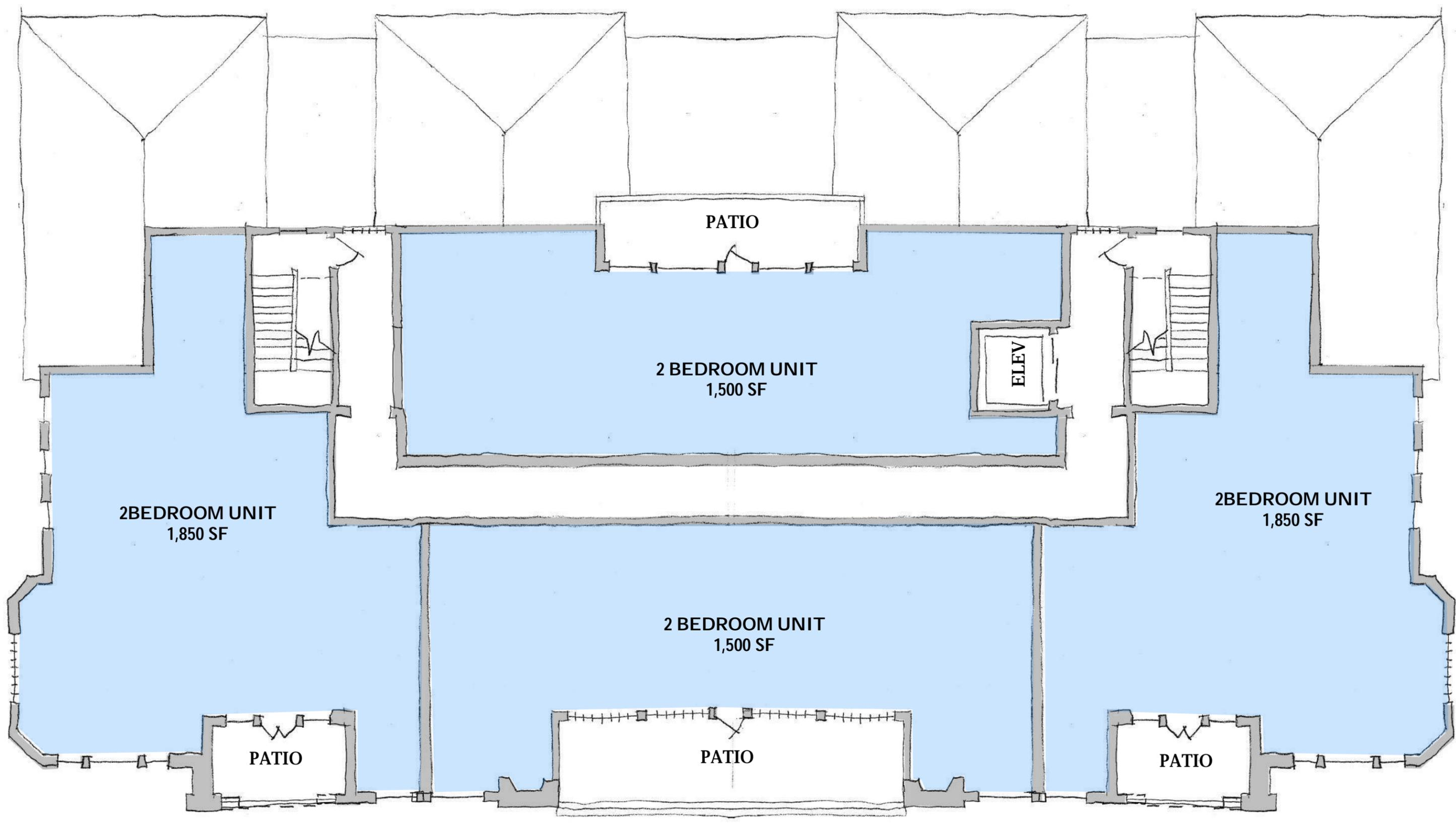

CONDO B LEVEL TWO PLAN
NTS

MONTEVALLO ROAD

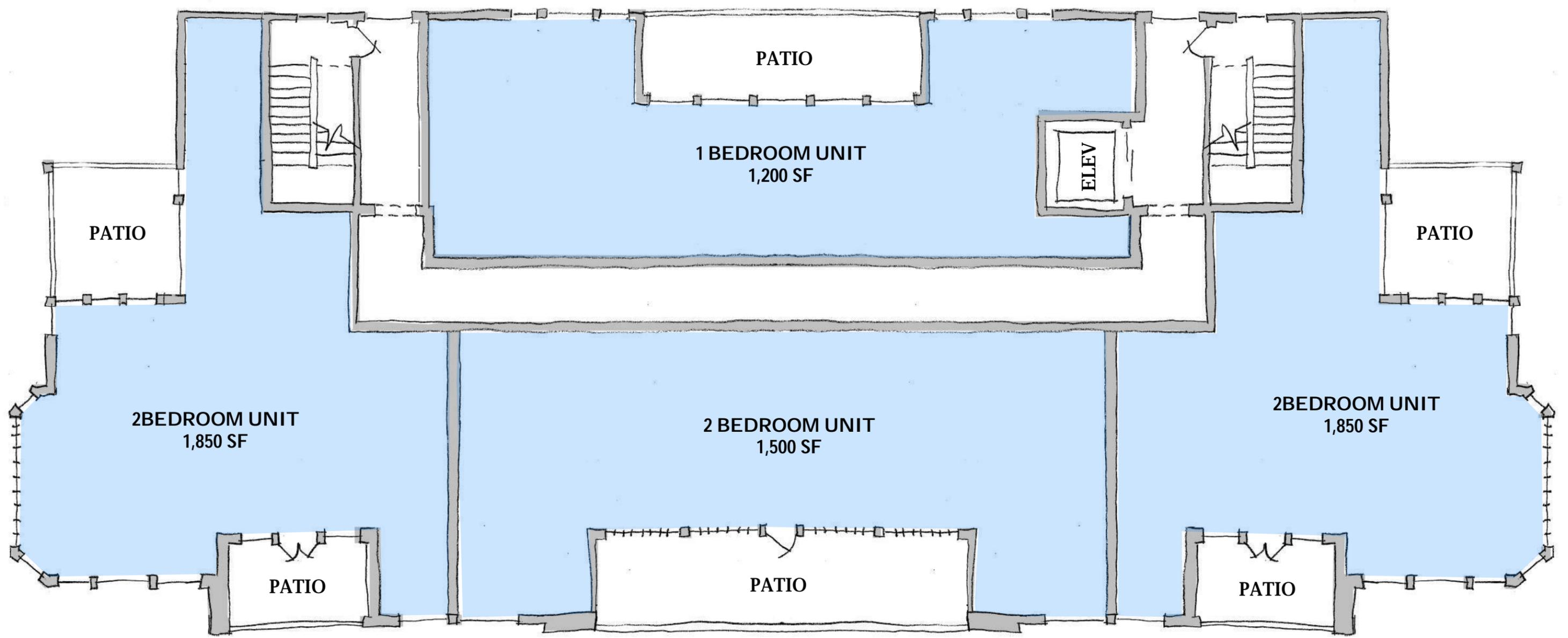

CONDO B LEVEL THREE PLAN
NTS

MONTEVALLO ROAD

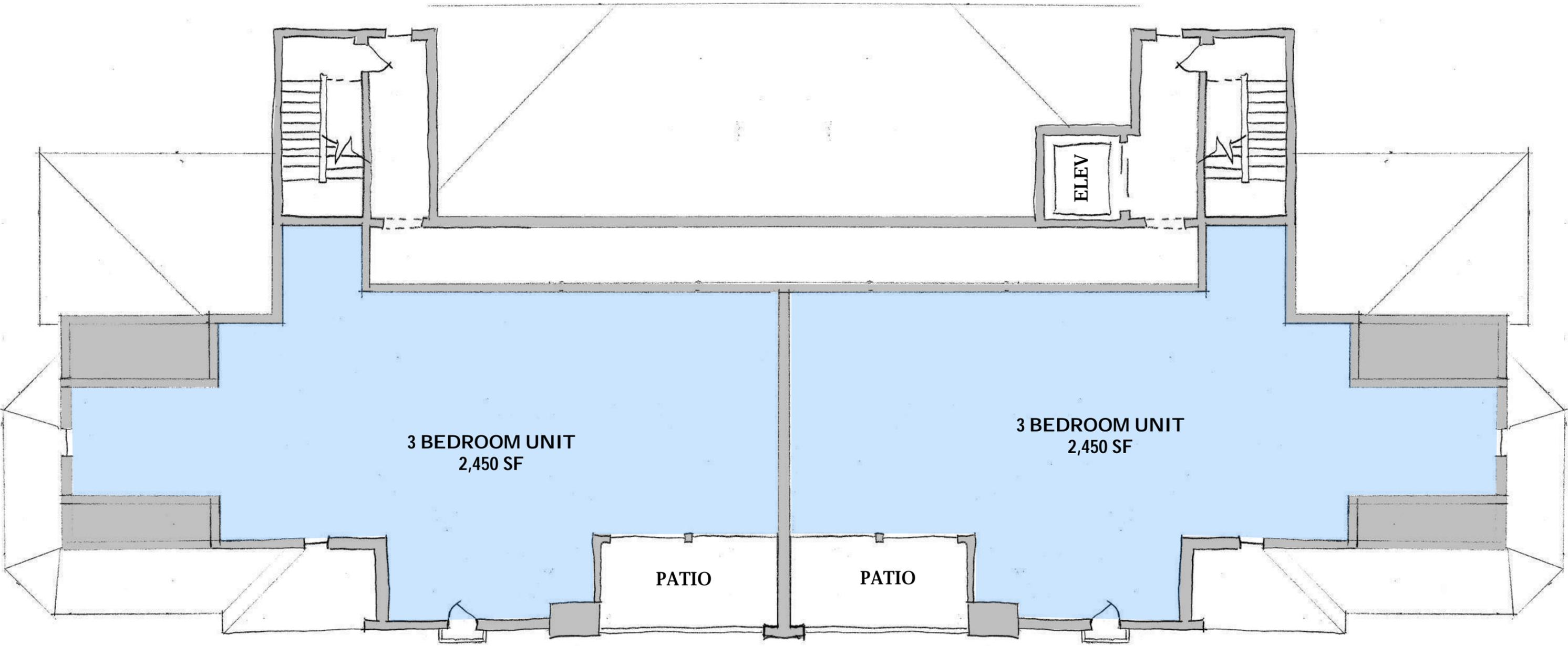

CONDO B ATTIC LEVEL PLAN
NTS

MONTEVALLO ROAD



CONDO B MONTEVALLO ROAD ELEVATION



CONDO B WEST ELEVATION



CONDO B EAST ELEVATION



CONDO B SOUTH ELEVATION

APPENDIX C
3-D MODEL IMAGES

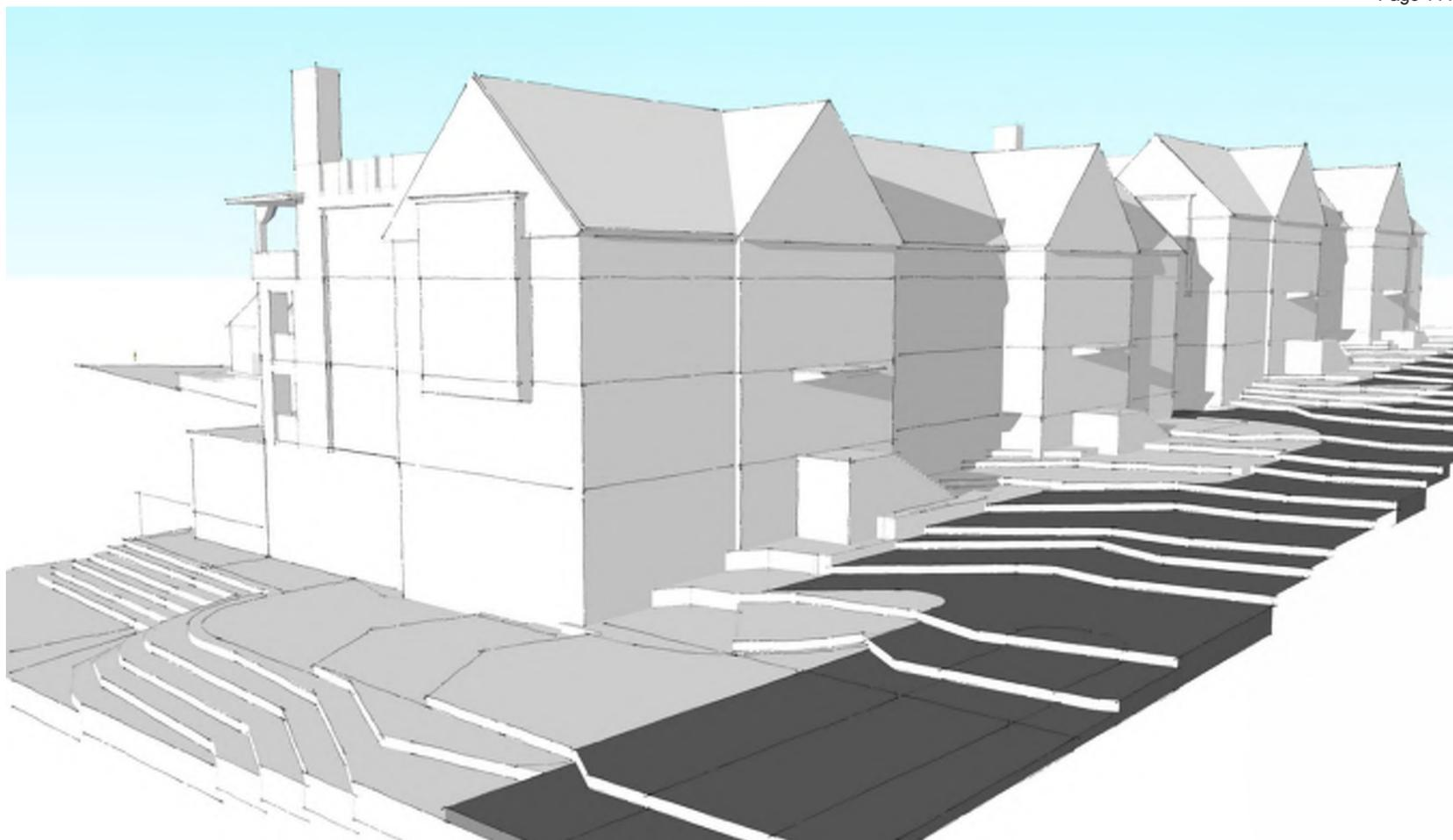

LOOKING WEST ON MONTEVALLO ROAD

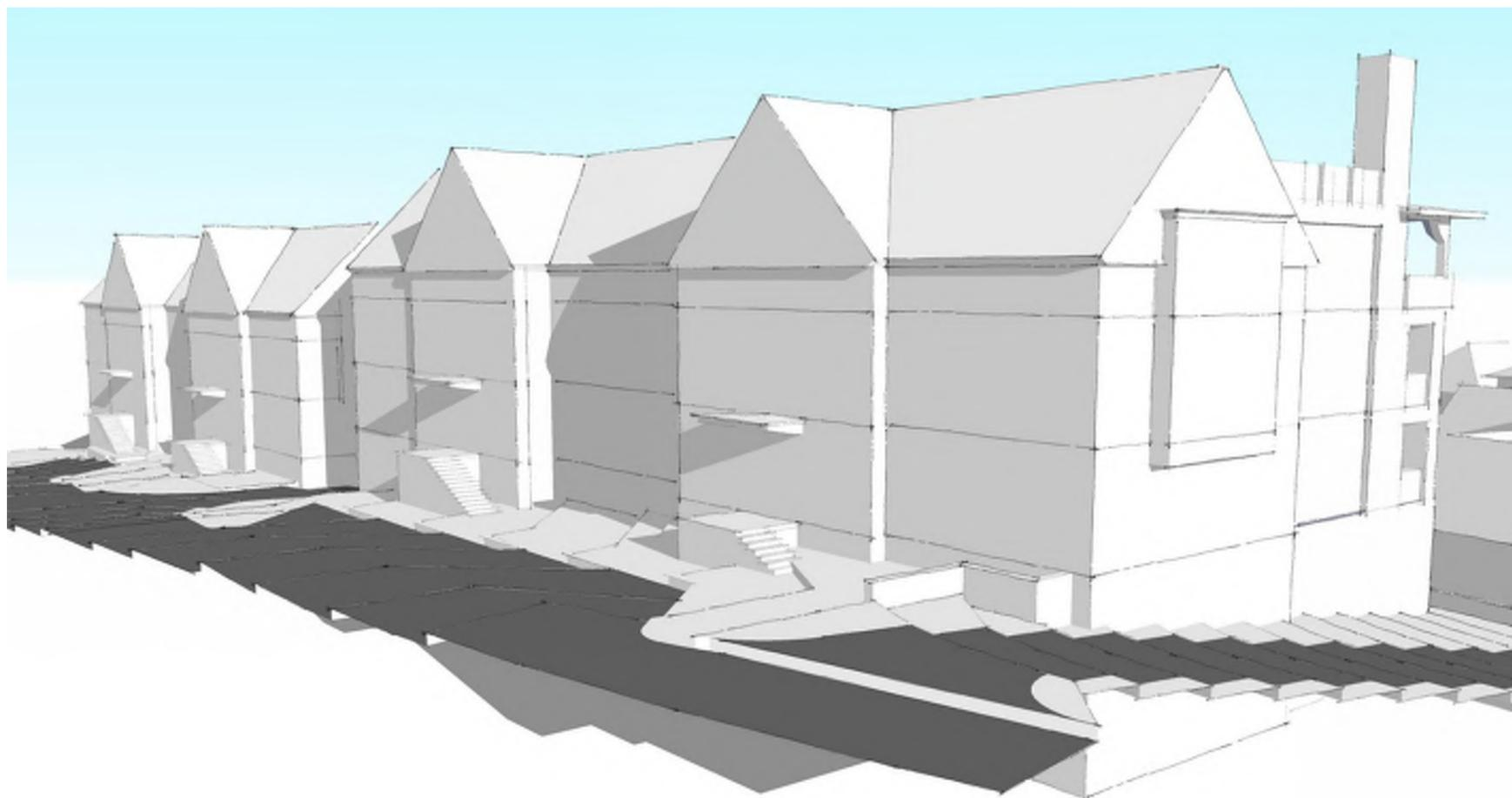

LOOKING EAST ON MONTEVALLO ROAD



LOOKING WEST ON SINGLE FAMILY

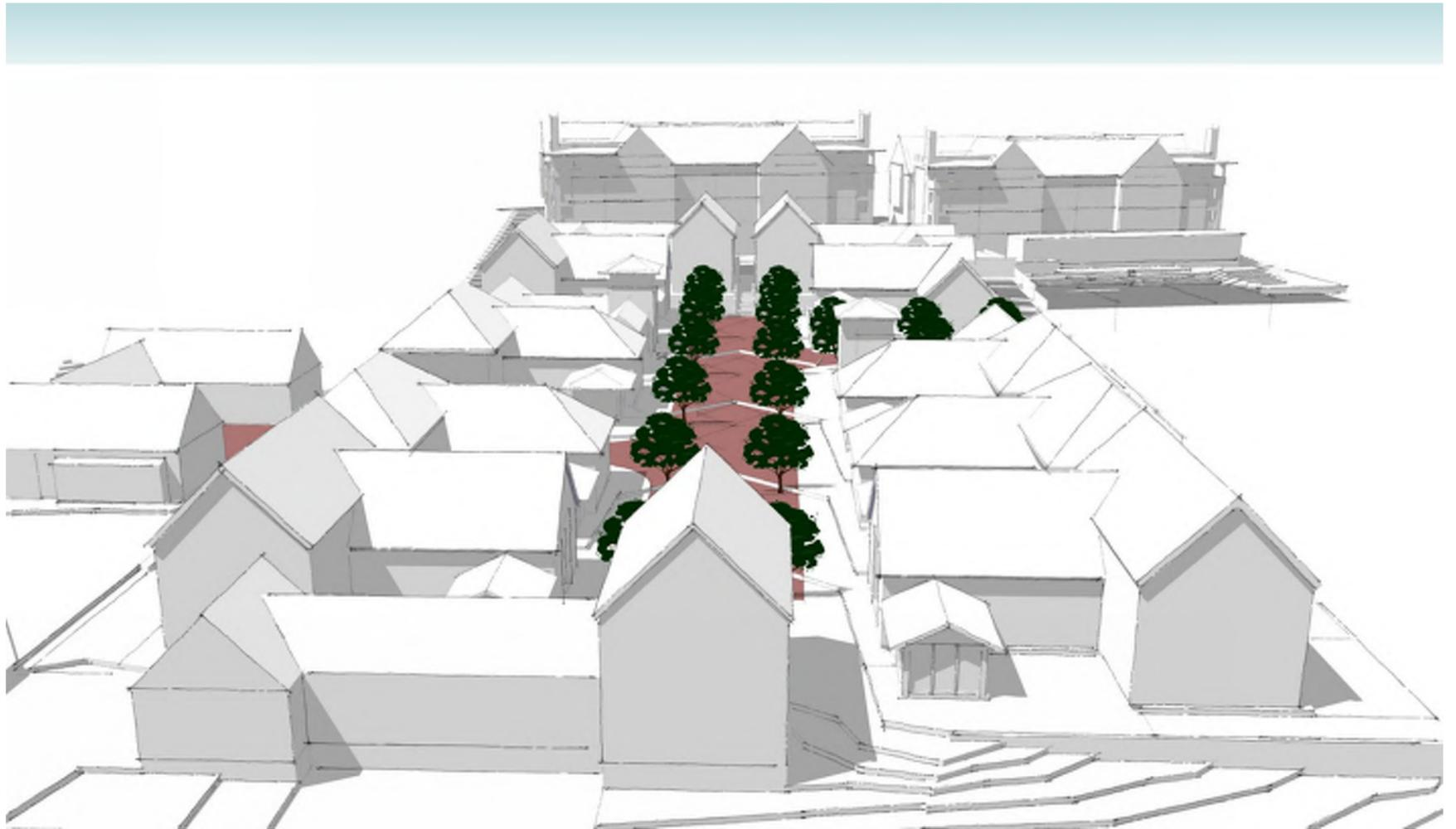

SINGLE FAMILY FROM SOUTH



LOOKING NORTHWEST FROM CHESTER ROAD



TOWARDS MONTEVALLO ROAD FROM CHESTER ROAD

APPENDIX D
CONCEPTUAL LANDSCAPE PLAN



Conceptual Plant Schedule

- CANOPY TREE**
 - Metasequoia glyptostroboides Arrowhead / Arrowhead Dawn Redwood
 - Quercus alba / White Oak
 - Quercus borealis / Northern Red Oak
 - Quercus lyrata OLFB TM / Highbeam Overcup Oak
 - Quercus nuttallii / Nuttall Oak
 - Quercus shumardii / Shumard Oak
 - Tilia americana Durable / American Linden
 - Tilia cordata / Littleleaf Linden
 - Ulmus americana Jefferson / Jefferson American Elm
 - Ulmus americana USANT TM / Create Queen American Elm
 - Ulmus parvifolia / Lacebark Elm
- UNDERSTORY STREET TREE**
 - Corpus caroliniana COSSU TM / Palisade American Hornbeam
 - Corpus caroliniana JPS-KING TM / Native Flame American Hornbeam
 - Chionanthus virginicus Grassy Graybeard / Grassy Graybeard White Fringetree
 - STD - SINGLE STEM
 - Crataegus viridis Winter King / Winter King Hawthorn
 - Ilex x Savannah / Savannah Holly
 - LIMBED UP 5' TO TREE FORM
 - Magnolia virginiana / Sweetbay Magnolia
 - Ilex x glaucocarpa Small Sweet / Small Creek Chaste Tree
 - LIMBED UP 5' TO TREE FORM
- UNDERSTORY TREE**

(IN ADDITION TO UNDERSTORY STREET TREES, NOT ACCEPTABLE AS STREET TREES DUE TO THE NEED FOR MORE PROTECTION FROM THE SUN)

 - Acer palmatum Bloodgood 551 / Bloodgood Japanese Maple
 - STD - SINGLE STEM
 - Acer palmatum 'Sango-kaku' / Coral Bark Japanese Maple
 - Acer palmatum 'Serp' / Serp Japanese Maple
 - Cercis canadensis / Eastern Redbud
 - Cornus florida / Flowering Dogwood
 - Magnolia grandiflora Little Gem / Little Gem Dwarf Southern Magnolia
 - Magnolia grandiflora Southern Charm TM / Teddy Bear Southern Magnolia
 - Magnolia stellata / Star Magnolia
 - Magnolia virginiana / Sweetbay Magnolia
 - Magnolia virginiana 'Green Shadow' / Green Shadow Sweetbay Magnolia
 - STD - SINGLE STEM
 - Magnolia virginiana 'MYMTI' TM / Kalyk Sweetbay Magnolia
 - MULTI-STEM
 - Magnolia x 'Butterflies' / Butterflies Magnolia
 - STD - SINGLE STEM
 - Magnolia x soulangeana Dark Alexandrina / Dark Alexandrina Saucer Magnolia
 - MULTI-STEM
 - Osmanthus fragrans / Sweet Olive
 - LIMBED UP 5' TO TREE FORM
 - Juniperus virginiana 'Jaylind' / Jaylind Red Cedar
 - Juniperus virginiana Taylor / Taylor Juniper
- EVERGREEN BUFFER TREE**
 - Crataegus japonica 'Yoshino' / Yoshino Japanese Cedar
 - Cupressus arizonica glabra Blue Ice / Blue Ice Arizona Cypress
 - Cupressus sempervirens / Italian Cypress
 - Ilex latifolia 'LDS' TM / Cool Fences Lusterleaf Holly
 - Ilex x 'Mary Nell' / Mary Nell Holly
 - Ilex x 'Savannah' / Savannah Holly
 - Magnolia grandiflora Little Gem / Little Gem Dwarf Southern Magnolia
 - Magnolia grandiflora Southern Charm TM / Teddy Bear Southern Magnolia
 - Osmanthus fragrans / Sweet Olive
 - LIMBED UP 5' TO TREE FORM
 - Thuja occidentalis 'Heiz Wintergreen' / Heiz Wintergreen Arborvitae
 - Thuja occidentalis 'Emerald' / Emerald Green Arborvitae
 - Thuja x 'Green Giant' / Green Giant Arborvitae

- EVERGREEN BUFFER SHRUBS**

(SHRUBS SHALL BE PLANTED BELOW POWER LINES ALONG THE PROPERTY BOUNDARY NORTH OF CHESTER ROAD AND MAINTAINED AT 6' HEIGHT MAXIMUM HEDGE AFTER INSTALLATION)

 - Ilex latifolia 'LDS' TM / Cool Fences Lusterleaf Holly
 - Ilex x 'Mary Nell' / Mary Nell Holly
 - Ilex x 'Savannah' / Savannah Holly
 - Osmanthus fragrans / Sweet Olive
 - Prunus caroliniana Hunter / Hunter Cherry Laurel
- MEDIUM - LARGE SHRUBS**
 - Camellia japonica / Camellia
 - Camellia sasanqua / Sasanqua Camellia
 - Cornus sericea / Red Twig Dogwood
 - Forsythia ovata 'Sunrise' / Sunrise Forsythia
 - Forsythia x intermedia / Border Forsythia
 - Hydrangea aquifolium / Oakleaf Hydrangea
 - Ilex cornuta 'Burfordii Nana' / Dwarf Burford Holly
 - Ilex x 'Rustic II' TM / Emerald Colonial Holly
 - BOXWOOD FORM
 - Prunus laurocerasus 'Schipkaensis' / Schipka English Laurel
 - Spiraea cantoniensis / Reeves Spirea
 - Thuja occidentalis 'Holmstrup' / Holmstrup Arborvitae
 - Thuja occidentalis 'Emerald' / Emerald Green Arborvitae
 - Viburnum dentatum / Viburnum
 - Viburnum x burkwoodii / Burkwood Viburnum
- SMALL - MEDIUM SHRUB**
 - Azalea x 'Roblex' TM / Autumn Lily Encore Azalea
 - Distylium x 'PILIDIST-II' TM / Emerald Heights Distylium
 - Distylium 'PILIDIST-III' TM / Blue Cascade Distylium
 - Distylium x 'PILIDIST-III' TM / Coppertone Distylium
 - Distylium x 'Vintage Jade' / Vintage Jade Distylium
 - Gardenia jasminoides 'Frostproof' / Frostproof Gardenia
 - Hydrangea arborescens / Wild Hydrangea
 - Hydrangea macrophylla / Largeleaf Hydrangea
 - Ilex vomitoria 'Nana' / Dwarf Yaupon Holly
 - Ilex vomitoria 'Sikes Dwarf' / Sikes Dwarf Yaupon Holly
 - Thuja occidentalis 'Congo' TM / Fire Chief Arborvitae
 - Viburnum davidii / David Viburnum
- VINES**
 - Sesamium sempervirens / Carolina Jessamine
 - Lonicera sempervirens 'Alabama Crimson' / Alabama Crimson Trumpet Honeysuckle
 - Rosa banksiae / Lady Banks Rose
 - Rosa x 'Cecile Brunner' / Cecile Brunner Climbing Rose
- ORNAMENTAL GRASSES**
 - Bouteloua gracilis / Blue Grama Grass
 - Calamagrostis x acutiflora Karl Foerster / Karl Foerster Feather Reed Grass
 - Festuca glauca / Blue Fescue
 - Helictotrichon sempervirens / Blue Oat Grass
 - Muhlenbergia capillaris 'White Cloud' / White Cloud Muhly Grass
 - Stipa tenuissima / Mexican Feather Grass

- GROUND COVER**
 - Abelia x grandiflora 'Prostrata' / Prostrate Glossy Abelia
 - Ajuga reptans / Carpet Bugle
 - Impatiens horizontalis 'Blue Rug' / Blue Rug Impatiens
 - Phlox subulata / Creeping Phlox
 - Sedum album / Stonecrop
 - Sedum rupestre 'Angelina' / Angelina Sedum
- SHADE GROUND COVER**
 - Athyrium filix-femina / Common Lady Fern
 - Dracopis angustifolia / Autumn Fern
 - Hakonechloa macra / Japanese Forest Grass
 - Osmunda cinnamomea / Cinnamon Fern
- PERENNIALS**
 - Allium sphaerocephalon / Drumstick Allium
 - Allium x Globemaster / Globemaster Ornamental Onion
 - Echinacea purpurea / Coneflower
 - Hemerocallis x / Hybrid Daylily
 - Hemerocallis x 'Stella de Oro' / Stella de Oro Daylily
 - Hosta x / Hosta
 - Hosta x 'June' / June Hosta
 - Iris sibirica / Siberian Iris
 - Iris virginica / Blue Flag Iris
 - Lavandula angustifolia / English Lavender
 - Leucanthemum x superbum / Shasta Daisy
 - Liatris spicata / Blazing Star
 - Penstemon digitalis / Beardtongue
 - Rudbeckia hirta / Black-eyed Susan
 - Ruellia humilis / Wild Petunia
 - Stachys byzantina / Lamb's Ear
- TURF (SOD)**
 - Zoysia japonica 'El Toro' / El Toro Zoysia Grass
- EROSION CONTROL GROUND COVER**
 - Andropogon ternarius Black Mountain / Black Mountain Spillbeard Bluestem
 - Seed or Plugs
 - Bouteloua curtipendula / Side Oats Grama
 - Seed or Plugs
 - Carex amplicarpa / Creek Sedge
 - Seed or Plugs
 - Carex bicknellii / Prairie Sedge
 - Seed or Plugs
 - Carex crinita / Mexican Feather Grass
 - Seed or Plugs
 - Fanicum virgatum / Switch Grass
 - Seed or Plugs

INVASIVE & UNDESIRABLE PLANTS

- TREES**
 - Tree of Heaven (Ailanthus altissima (P. Mill.) Swingle)
 - Silktree, Mimosa (Albizia julibrissin)
 - Princess Tree (Paulownia tomentosa)
 - Bradford Pear (Pyrus calleryana)
 - Chinese Tallowtree, Popcorn Tree (Triadica sebifera)
 - Beach Vitex (Vitex rotundifolia L. f.)
 - Sawtooth Oak (Quercus acutissima Carruthers)

- (DUE TO DISEASE)**
 - Crabapple (Lagerstroemia)
 - Ash (Fraxinus)
- SHRUBS**
 - Japanese Barberry (Berberis thunbergii DC.)
 - Autumn Olive (Elaeagnus umbellata Thunb.)
 - Thorny Olive (Elaeagnus pungens)
 - Amur Honeysuckle (Lonicera maackii (Rupr.) Herder)
 - Chinese Wisteria (Lonicera x bella)

- SHRUBS CONT.**
 - Chinese Privet (Ligustrum sinense)
 - Glossy Privet (Ligustrum lucidum W.T. Aiton)
 - Tropical Soda Apple (Solanum viarum)
 - Kudzu (Pueraria montana)
 - Japanese Honeysuckle (Lonicera japonica Thunb.)
 - Japanese Climbing Fern (Lygodium japonicum)
 - Chinese Wisteria (Wisteria sinensis (Sims) DC.)

- SHRUBS CONT.**
 - Japanese Spirea (Spiraea japonica L. f.)
 - Leatherleaf Mahonia (Mahonia bealei (Fortune) Carr.)
 - Nandina (Nandina domestica Thunb.)
 - Johnson Grass (Sorghum halepense (L.) Pers.)
 - Cogongrass (Imperata cylindrica)
 - Japanese stiltgrass (Microstegium vimineum)
 - Giant Reed (Arundo donax)

- VINES + GROUNDCOVERS**
 - Wintercreeper (Euonymus fortunei (Turcz.) Hand-Maz.)
 - Periwinkle (Vinca minor L.)
 - English Ivy (Hedera helix L.)
- FORBS / HERBS**
 - Alligator Weed (Alternanthera philoxeroides (Mart.) Griseb.)
 - Chinese or Sericea Lespedeza (Lespedeza cuneata)

- VINES + GROUNDCOVERS CONT.**
 - Shrubby or Bicolor Lespedeza (Lespedeza bicolor)
 - Benghal Dayflower (Commelina benghalensis)
 - Wild Garlic (Allium vineale L.)

PUBLIC SPACE LANDSCAPE CHARACTER & INTENT

- PUBLIC LANDSCAPE AREAS SHALL PROMOTE FORMAL LANDSCAPE PRINCIPALS OF SYMMETRY AND BALANCE.
- PLANTS LOCATED WITHIN PUBLIC AREAS SHOULD BE PRIMARILY WHITE IF FLOWERING.



CANOPY
TREES

STREET
TREES

UNDERSTORY
TREES

EVERGREEN
BUFFER
TREES

EVERGREEN
BUFFER
SHRUBS

SHRUBS

GREEN
WALL

ORNAMENTAL
GRASSES

GROUND
COVER

PERENNIALS

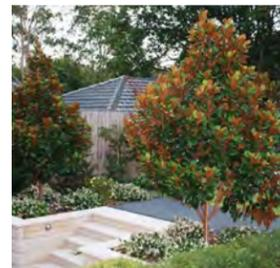
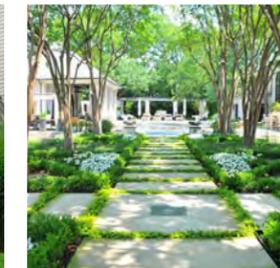
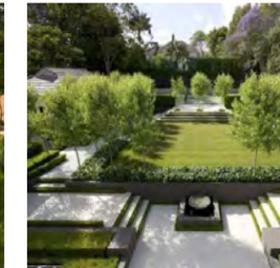
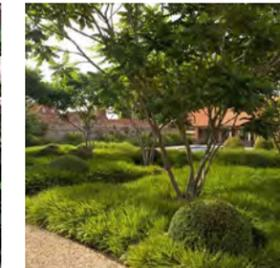

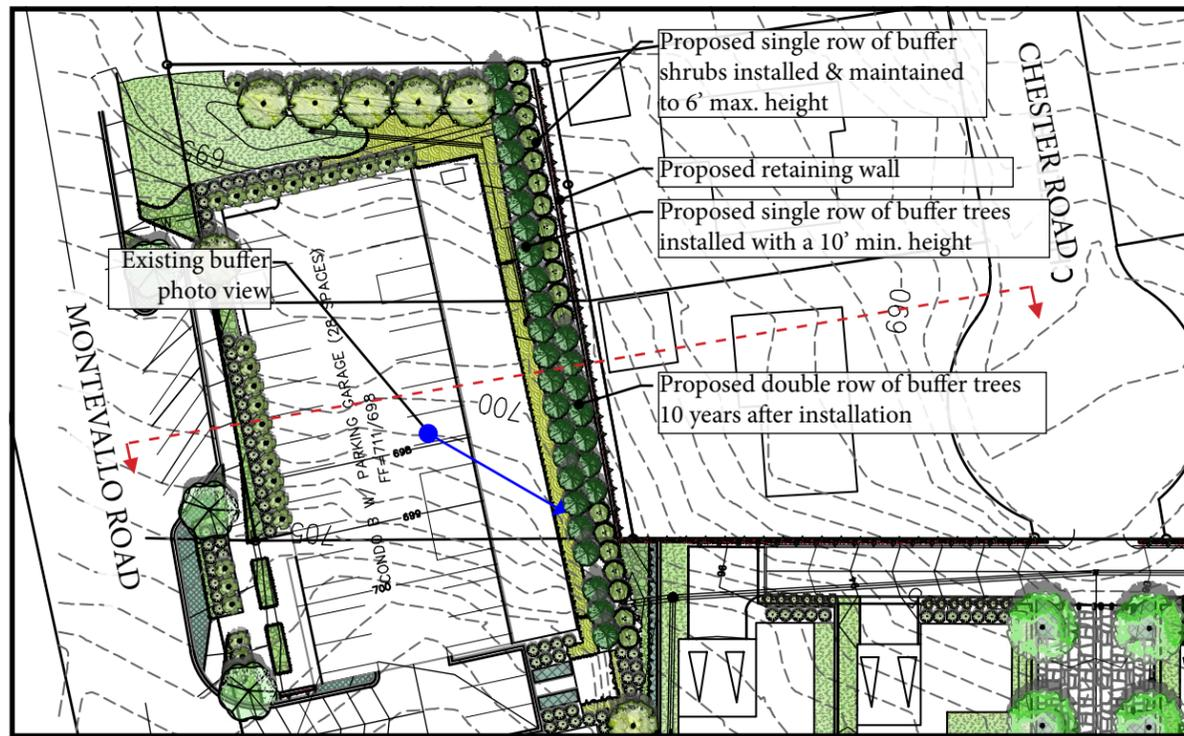

Section Location Map

Conceptual Buffer Plant Schedule

- EVERGREEN BUFFER TREE**
- Cryptomeria japonica* 'Yoshino' / Yoshino Japanese Cedar
 - Cupressus arizonica glabra* 'Blue Ice' / Blue Ice Arizona Cypress
 - Cupressus sempervirens* / Italian Cypress
 - Ilex latifolia* 'ILDG' TM / Cool Fences Lusterleaf Holly
 - Ilex* x 'Mary Nell' / Mary Nell Holly
 - Ilex* x 'Savannah' / Savannah Holly
 - Magnolia grandiflora* 'Little Gem' / Little Gem Dwarf Southern Magnolia
 - Magnolia grandiflora* 'Southern Charm' TM / Teddy Bear Southern Magnolia
 - Osmanthus fragrans* / Sweet Olive
- LIMBED UP TO TREE FORM**
- Thuja occidentalis* 'Hetz Wintergreen' / Hetz Wintergreen Arborvitae
 - Thuja occidentalis* 'Holmstrup' / Holmstrup Arborvitae
 - Thuja occidentalis* 'Smaragd' / Emerald Green Arborvitae
 - Thuja* x 'Green Giant' / Green Giant Arborvitae
- B#B, 16' Min.
 - B#B, 12' Min.
 - B#B, 14' Min.
 - B#B, 12' Min.
 - B#B, 12' Min.
 - B#B, 12' Min.
 - B#B, 3" Cal., 14' Min.
 - B#B, 12' Min.
 - B#B, 12' Min.
 - B#B, 6' Min.
 - B#B, 14' Min.
 - B#B, 8' Min.
 - B#B, 10' Min.
 - B#B, 16' Min.

- EVERGREEN BUFFER BELOW POWER LINES MAINTAINED AT 6' HEIGHT MAXIMUM HEDGE AFTER INSTALLATION**
- Ilex latifolia* 'ILDG' TM / Cool Fences Lusterleaf Holly
 - Ilex* x 'Mary Nell' / Mary Nell Holly
 - Ilex* x 'Savannah' / Savannah Holly
- TREE FORM**
- Osmanthus fragrans* / Sweet Olive
- LIMBED UP TO TREE FORM**
- Prunus caroliniana* 'Hunter' / Hunter Cherry Laurel
- B#B, 12' Min.
 - B#B, 12' Min.
 - B#B, 5" Cal., 12' Min.
 - B#B, 6' Min.
 - B#B, 6' Min.



Photo: Existing buffer located on adjacent property (2304 Chester Road)

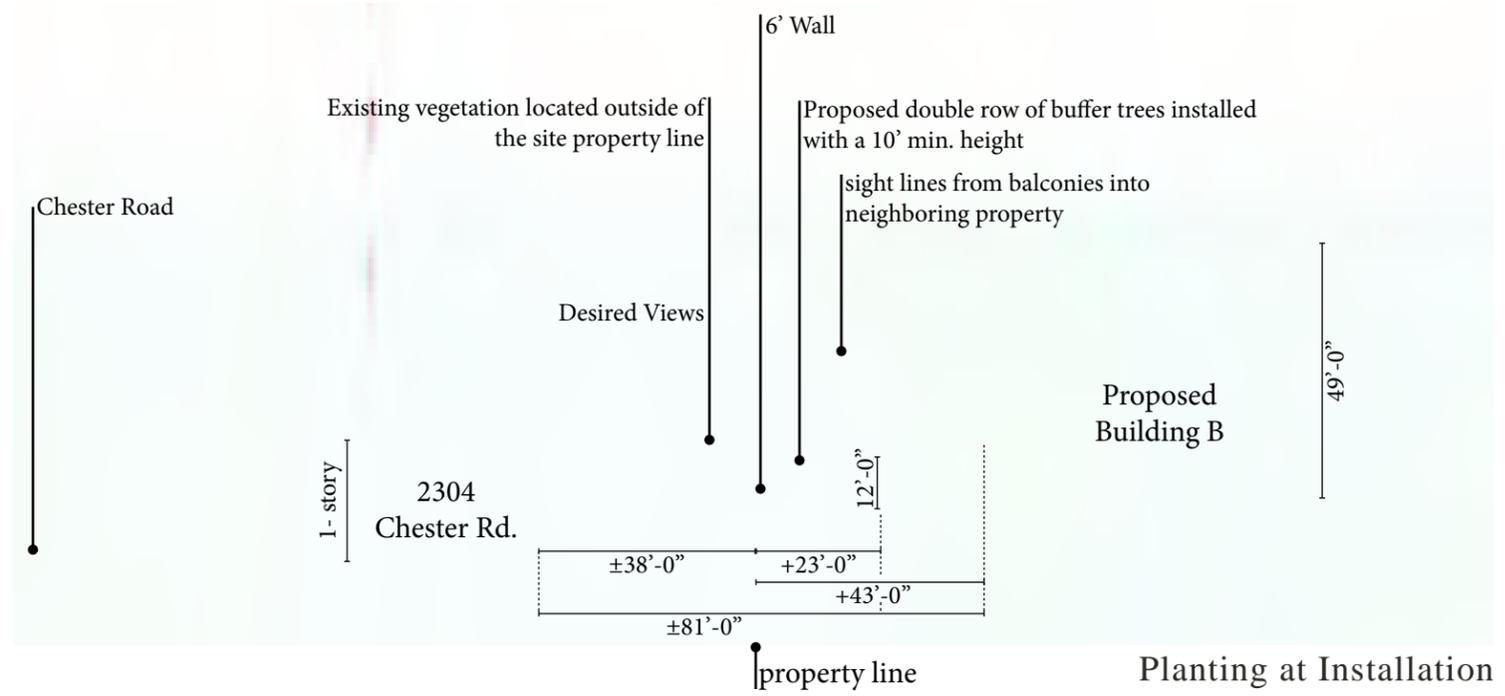

Planting at Installation

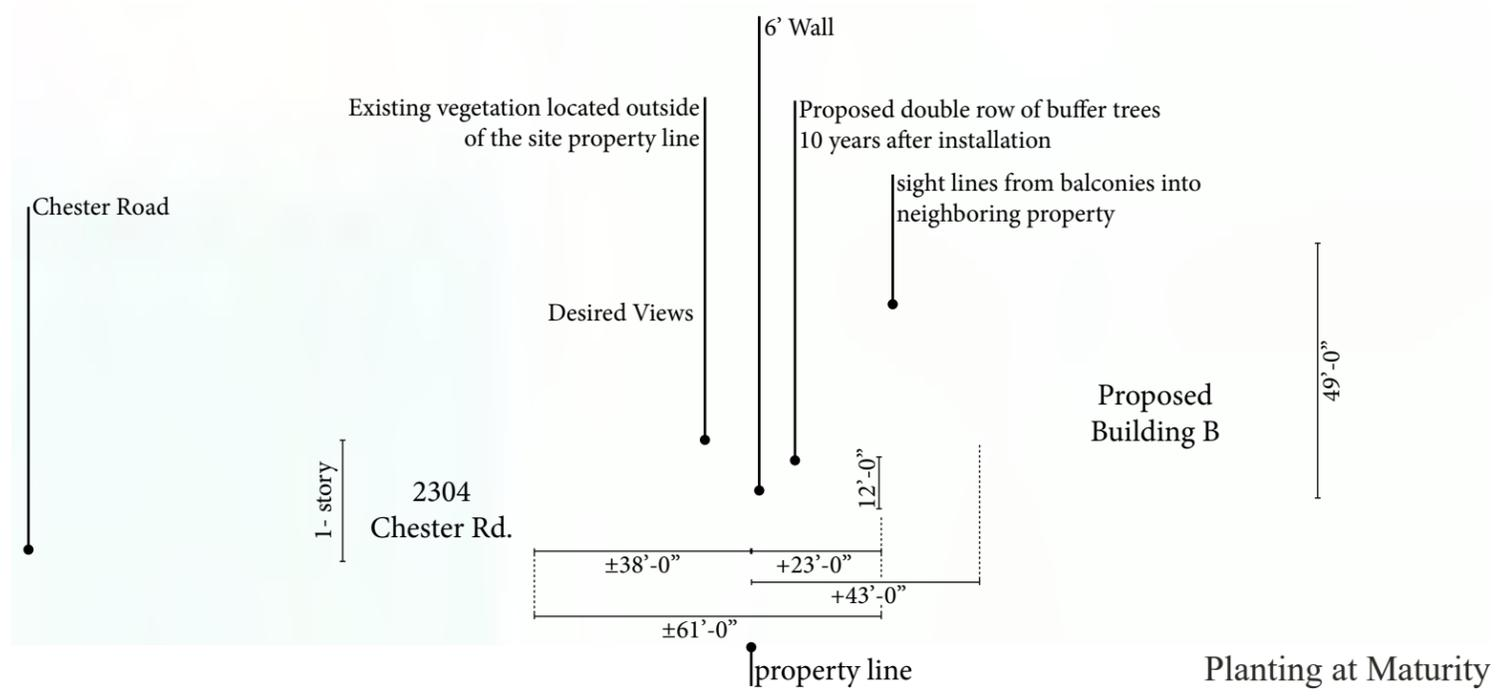

Planting at Maturity

2304 Chester Road Illustrative Evergreen Buffer Section

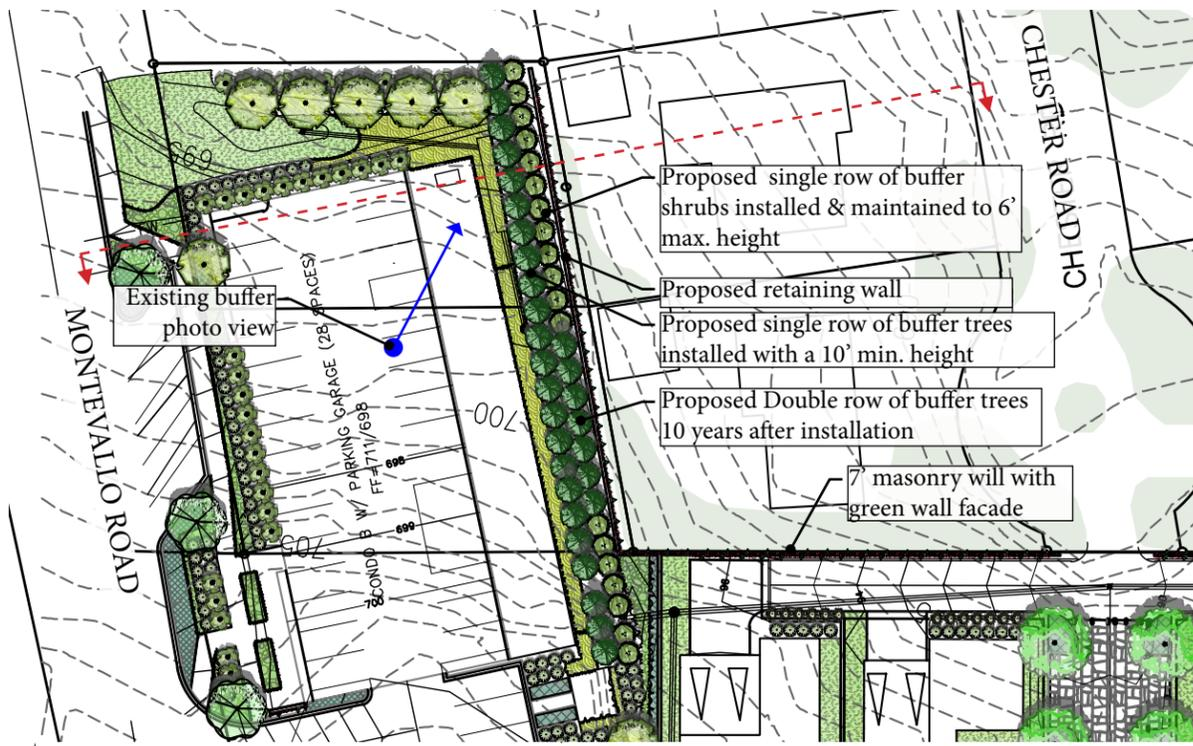

Section Location Map

Conceptual Buffer Plant Schedule

- EVERGREEN BUFFER TREE**
- Cryptomeria japonica* 'Yoshino' / Yoshino Japanese Cedar
 - Cupressus arizonica glabra* 'Blue Ice' / Blue Ice Arizona Cypress
 - Cupressus sempervirens* / Italian Cypress
 - Ilex latifolia* 'LDS' TM / Cool Fences Lusterleaf Holly
 - Ilex* x 'Mary Nell' / Mary Nell Holly
 - Ilex* x 'Savannah' / Savannah Holly
 - Magnolia grandiflora* 'Little Gem' / Little Gem Dwarf Southern Magnolia
 - Magnolia grandiflora* 'Southern Charm' TM / Teddy Bear Southern Magnolia
 - Osmanthus fragrans* / Sweet Olive
- LIMBED UP TO TREE FORM**
- Thuja occidentalis* 'Hetz Wintergreen' / Hetz Wintergreen Arborvitae
 - Thuja occidentalis* 'Holmstrup' / Holmstrup Arborvitae
 - Thuja occidentalis* 'Smaragd' / Emerald Green Arborvitae
 - Thuja* x 'Green Giant' / Green Giant Arborvitae
- EVERGREEN BUFFER BELOW POWER LINES**
- MAINTAINED AT 6' HEIGHT MAXIMUM HEDGE AFTER INSTALLATION
- Ilex latifolia* 'LDS' TM / Cool Fences Lusterleaf Holly
 - Ilex* x 'Mary Nell' / Mary Nell Holly
 - Ilex* x 'Savannah' / Savannah Holly
- TREE FORM**
- Osmanthus fragrans* / Sweet Olive
 - Prunus caroliniana* 'Hunter' / Hunter Cherry Laurel
- B&B, 16' Min.
- B&B, 12' Min.
- B&B, 14' Min.
- B&B, 12' Min.
- B&B, 12' Min.
- B&B, 5' Cal., 14' Min.
- B&B, 12' Min.
- B&B, 12' Min.
- B&B, 6' Min.
- B&B, 14' Min.
- B&B, 8' Min.
- B&B, 10' Min.
- B&B, 16' Min.
- B&B, 12' Min.
- B&B, 12' Min.
- B&B, 5' Cal., 12' Min.
- B&B, 6' Min.
- B&B, 6' Min.



Photo: Existing buffer located on adjacent property (2310 Chester Road)

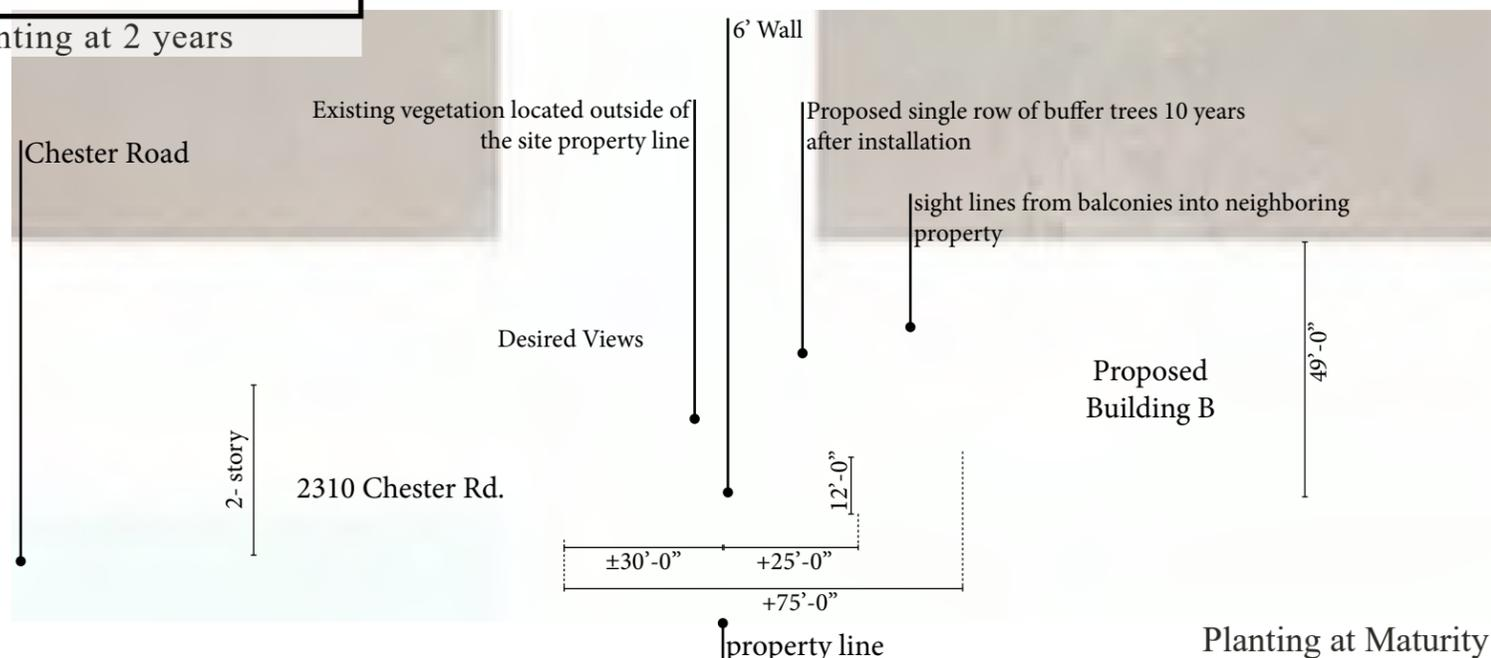
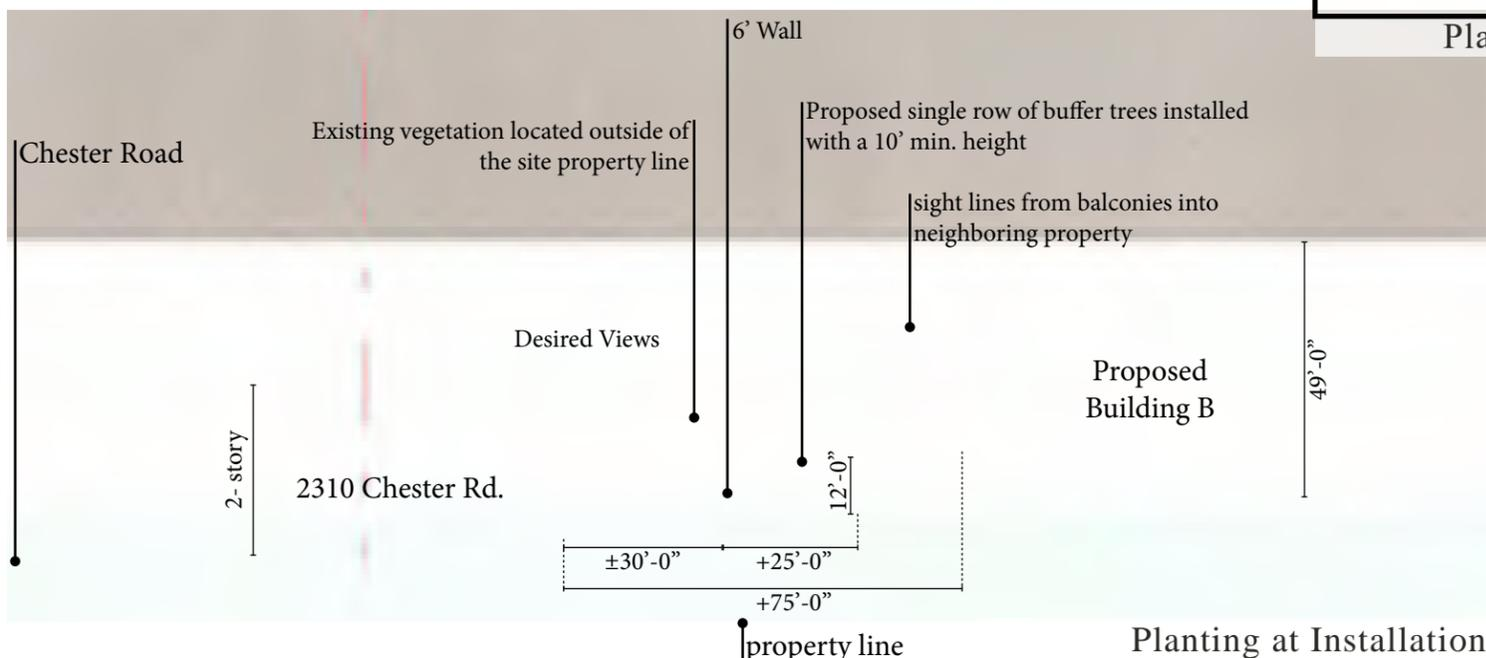
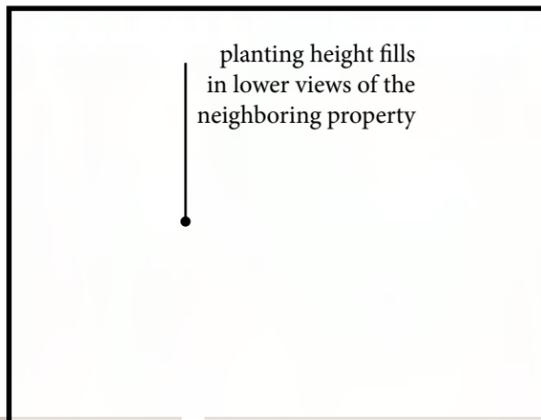

2310 Chester Road Illustrative Evergreen Buffer Section

APPENDIX A
TRAFFIC STUDY

Traffic Study

Redevelopment of 2305 Montevallo Road Mountain Brook, Alabama

Prepared for:

Ingram Farris, LLC

SKIPPER
CONSULTING INC

June, 2022

Redevelopment of 2305 Montevallo Road

Mountain Brook, Alabama

Prepared for:

Ingram Farris, LLC
1900 28th Avenue South, Suite 105
Homewood, Alabama 35209

Prepared by:

Skipper Consulting, Inc.
3644 Vann Road, Suite 100
Birmingham, Alabama 35235
Phone (205) 655-8855
Fax (205) 655-8825



SIGNED: *Richard Lynn Cagle*
DATE: 6/10/22

June, 2022

TABLE OF CONTENTS

	Page
Introduction	1
Existing Intersection Turning Movement Traffic Counts	1
Existing Machine Traffic Counts.....	1
Existing Intersection Capacity Analysis	4
Historical Traffic Growth	5
Background 2025 Traffic Volumes	6
Planned Roadway Improvement Project	6
Background 2025 Intersection Capacity Analysis	8
Trip Generation	9
Directional Distribution.....	9
Future 2025 Traffic Volumes.....	9
Future 2025 Intersection Capacity Analysis.....	9
Recommendations	9

APPENDICES

Appendix A	Proposed Site Plan
Appendix B	Existing Intersection Turning Movement Traffic Counts
Appendix C	Machine Traffic Counts
Appendix D	Existing Intersection Capacity Analysis Worksheets
Appendix E	Background 2025 Intersection Capacity Analysis Worksheets
Appendix F	Future 2025 Intersection Capacity Analysis Worksheets

LIST OF ILLUSTRATIONS

Figure		Page
1	Site Location Map.....	2
2	Existing Traffic Counts	3
3	Background 2025 Traffic Volumes	7
4	Directional Distribution	10
5	Future 2025 Traffic Volumes	11
Table		
1	Existing Machine Traffic Counts	4
2	Existing Intersection Capacity Analysis	5
3	Historical Traffic Growth	6
4	Background 2025 Intersection Capacity Analysis.....	8
5	Trip Generation	9
6	Future 2025 Intersection Capacity Analysis	12

Introduction

This report documents a traffic impact study performed for the proposed redevelopment of 2305 Montevallo Road in the City of Mountain Brook, Alabama. Currently, the site is occupied by Shades Valley Presbyterian Church. The location of the site with respect to the area roadway network is shown in Figure 1. The proposed redevelopment plan would replace the existing land use with:

- 32 condominium units
- 14 single family detached dwelling units

Currently, the site is accessed via three driveways on Montevallo Road and a restricted driveway at the cul-de-sac end of Chester Road. Proposed access to the site is via two driveways accessing Montevallo Road (one for the single family portion of the development and one for the condominium portion of the development) and an access to Chester Road (only for the single family portion of the development).

The proposed site plan is included in Appendix A.

Development buildout and full occupation of the site is projected to occur in 2025.

Study intersections addressed in this report are shown in Figure 1 and include:

- Hollywood Boulevard at the US-280 Entrance Ramp
- Montevallo Road at the US-280 Exit Ramp
- Montevallo Road at Brookhill Condominiums
- Montevallo Road at Cahaba Road
- Cahaba Road at Chester Road

Existing Intersection Turning Movement Traffic Counts

Existing intersection turning movement traffic counts were performed at the study intersections from 7:00 to 9:00 a.m. and 4:00 to 6:00 p.m. on Wednesday to Thursday, March 23 to 24, 2022 by Traffic Data, LLC on behalf of Skipper Consulting, Inc. The intersection turning movement traffic count data is included in Appendix B. The a.m. and p.m. peak hours of traffic flow at the study intersections were calculated. The a.m. and p.m. peak hour intersection turning movement traffic counts are shown in Figure 2.

Existing Machine Traffic Counts

Existing 24 hour machine traffic counts were performed on Montevallo Road east of U.S. Highway 280 and Cahaba Road south of Montevallo Road on Wednesday to Thursday, March 23 to 24, 2022 by Traffic Data, LLC on behalf of Skipper Consulting, Inc. the machine traffic count data is included in Appendix C. The machine traffic count data is summarized in Table 1.

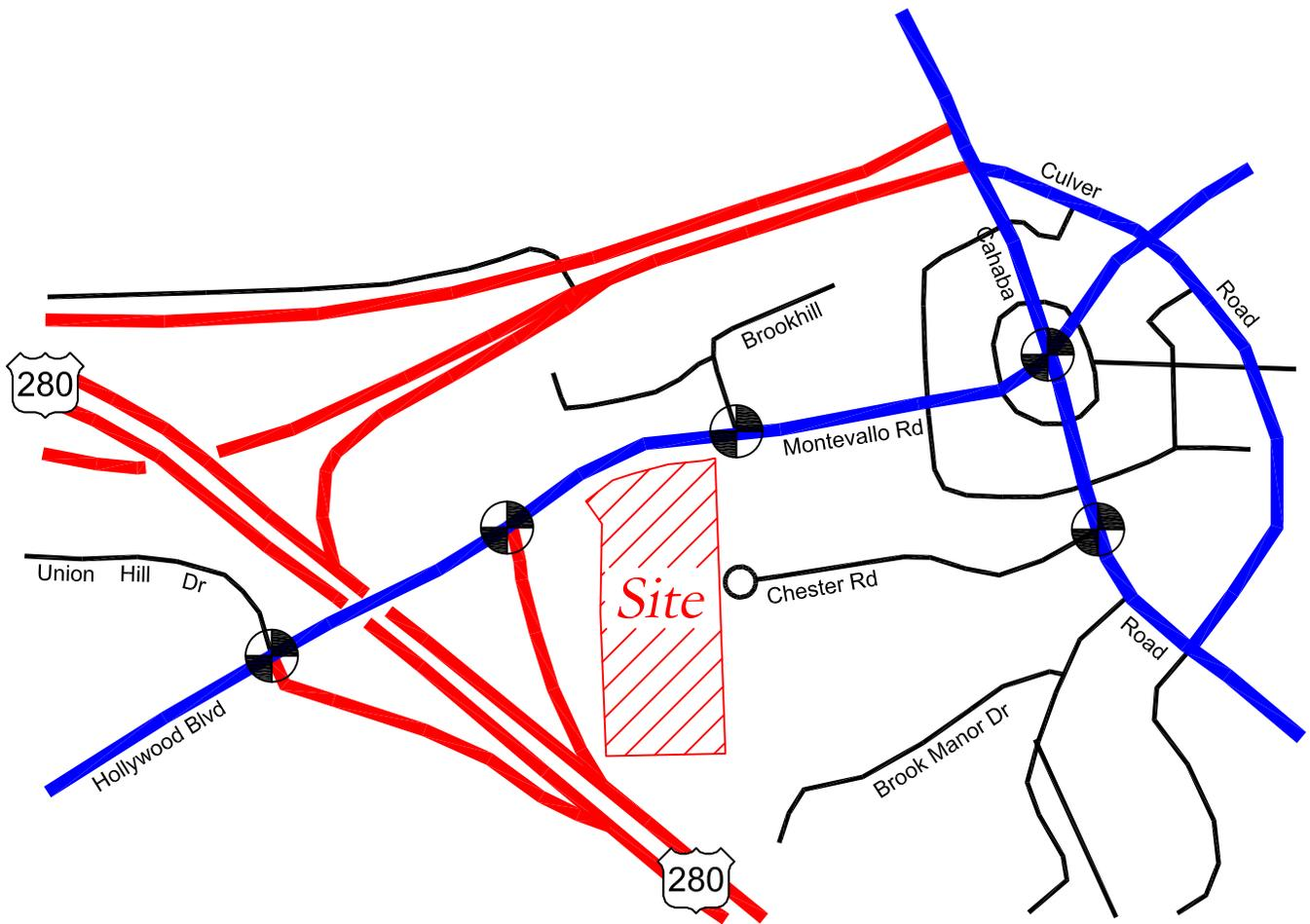

Legend

 Study Intersection



North
Scale: n.t.s

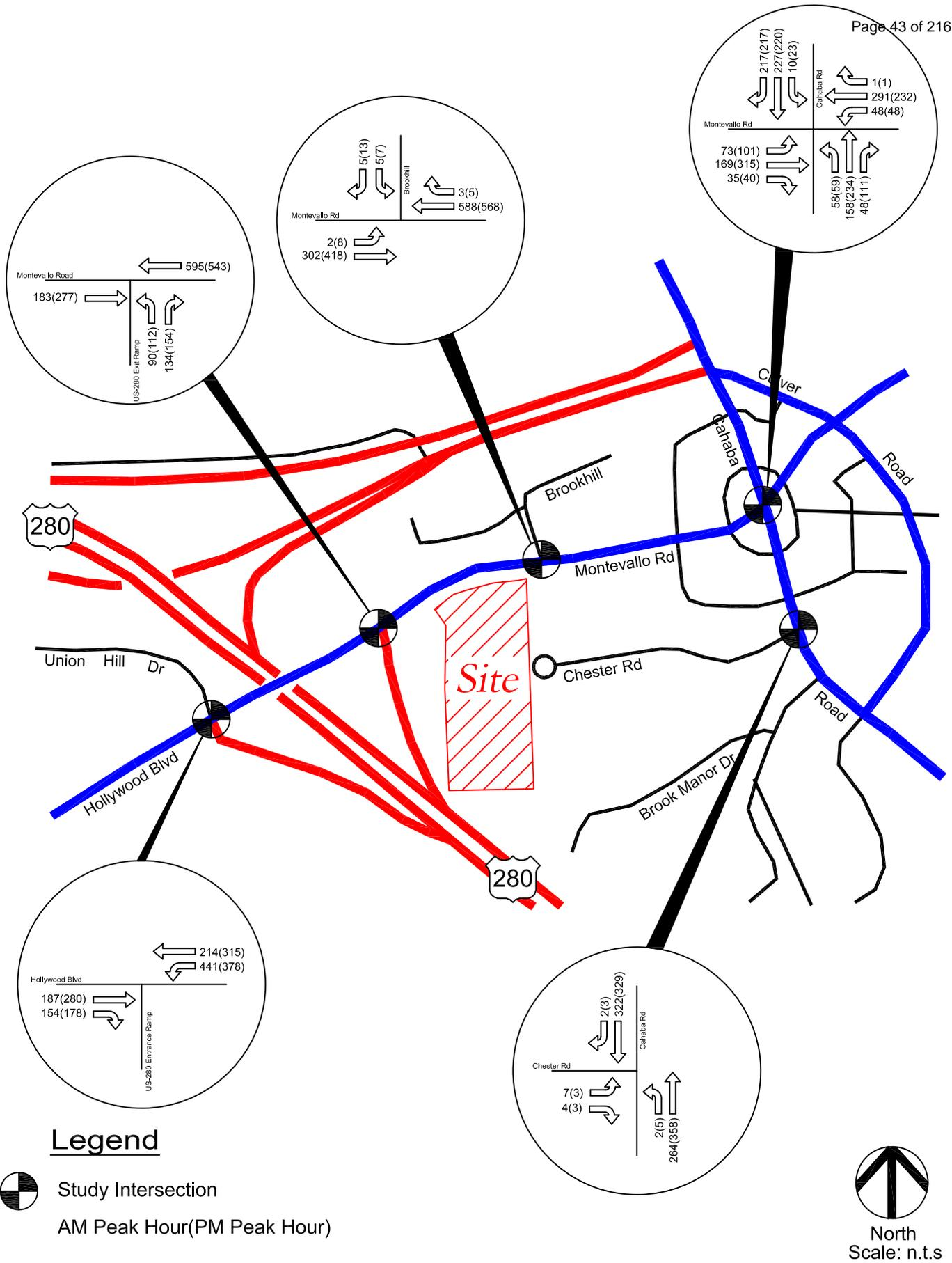

Table 1
Existing Machine Traffic Counts

<i>Time</i>	<i>Montevallo Road east of US-280</i>			<i>Cahaba Road south of Montevallo Road</i>		
	<i>Eastbound</i>	<i>Westbound</i>	<i>Total</i>	<i>Northbound</i>	<i>Southbound</i>	<i>Total</i>
12-1 AM	4	8	12	2	3	5
1-2 AM	1	6	7	2	0	2
2-3 AM	0	7	7	0	0	0
3-4 AM	1	6	7	2	5	7
4-5 AM	13	10	23	9	10	19
5-6 AM	53	61	114	17	21	38
6-7 AM	111	185	296	62	72	134
7-8 AM	277	518	795	215	261	476
8-9 AM	323	500	823	207	329	536
9-10 AM	343	477	820	263	296	559
10-11 AM	379	487	866	277	270	547
11-12 PM	410	578	988	398	328	726
12-1 PM	399	611	1010	420	347	767
1-2 PM	415	674	1089	364	352	716
2-3 PM	393	630	1023	385	325	710
3-4 PM	378	634	1012	406	281	687
4-5 PM	413	545	958	405	291	696
5-6 PM	413	521	934	391	322	713
6-7 PM	288	419	707	285	178	463
7-8 PM	184	278	462	203	139	342
8-9 PM	164	242	406	107	102	209
9-10 PM	68	152	220	72	58	130
10-11 PM	27	58	85	38	24	62
11-12 AM	6	25	31	4	8	12
Total	5063	7632	12695	4534	4022	8556

Existing Intersection Capacity Analysis

Existing a.m. and p.m. peak hour intersection capacity analyses were performed for the study intersections using the method of analysis included in the *Highway Capacity Manual*, published by the Transportation Research Board. Capacities are expressed as levels of service, and range from a level of service "A" (highest quality of service) to a level of service "F" (jammed conditions). As a general rule, operation at a level of service "C" or better is desirable, with a level of service "D" considered acceptable during peak hours of traffic flow. The results of the existing a.m. and p.m. peak hour intersection capacity analyses are included in Appendix D and are summarized in Table 2.

Table 2
Existing Intersection Capacity Analysis

<i>Intersection</i>	<i>Approach</i>	<i>Movement</i>	<i>Level of Service</i>	
			<i>AM Peak</i>	<i>PM Peak</i>
Montevallo Road at US-280 Entrance Ramp	Montevallo Road Westbound	Left-Through	A	A
Montevallo Road at US-280 Exit Ramp	US-280 Exit Ramp Northbound	Left	C	C
		Right	B	B
		<i>Overall approach</i>	<i>B</i>	<i>C</i>
Montevallo Road at Brookhill Condos	Montevallo Road Eastbound	Left	A	A
	Brookhill Southbound	Left-Right	C	C
Montevallo Road at Cahaba Road	Montevallo Road Eastbound	Left	B	B
		Through-Right	B	B
		<i>Overall approach</i>	<i>B</i>	<i>B</i>
	Montevallo Road Westbound	Left	A	B
		Through-Right	B	B
		<i>Overall approach</i>	<i>B</i>	<i>B</i>
	Cahaba Road Northbound	Left	A	A
		Through-Right	A	A
		<i>Overall approach</i>	<i>A</i>	<i>A</i>
	Cahaba Road Southbound	Left	A	A
		Through-Right	B	B
		<i>Overall approach</i>	<i>B</i>	<i>B</i>
<i>Overall intersection</i>			<i>B</i>	<i>B</i>
Cahaba Road at Chester Road	Cahaba Road Northbound	Left	A	A
	Chester Road Eastbound	Left-Right	B	B

Historical Traffic Growth

Historical traffic counts for the years 2014 to 2020 were obtained for Montevallo Road, Hollywood Boulevard, and Cahaba Road in the vicinity of the site from the Alabama Department of Transportation website. Traffic counts from the year 2020 were rejected because they appear to be significantly lower than 2019 traffic counts, probably due to Covid-19 impacts. An analysis was performed to determine the rate of traffic growth on the area roadways using the traffic count data from 2014 to 2019. The historical traffic counts and growth analysis is shown in Table 3. Montevallo Road has shown an increase in traffic, while Hollywood Boulevard and Cahaba Road have both shown decreases in traffic. Combining the results from all three count stations, and overall growth rate of 0.5% per year was calculated and was used for analysis in the remainder of this report.

Table 3
Historical Traffic Growth

Year	Montevallo Road		Hollywood Boulevard		Cahaba Road	
	Count	Growth	Count	Growth	Count	Growth
2014	11050		9040		8370	
2015	12040	9.0%	8160	-9.7%	8120	-3.0%
2016	12330	2.4%	8360	2.5%	8320	2.5%
2017	12390	0.5%	8420	0.7%	8270	-0.6%
2018	12855	3.8%	8736	3.8%	7897	-4.5%
2019	12840	-0.1%	8726	-0.1%	7888	-0.1%
average		3.1%		-0.6%		-1.1%
overall		3.2%		-0.7%		-1.2%

Background 2025 Traffic Volumes

Existing intersection turning movement traffic counts were projected forward to the year 2025 using the +0.5% per year traffic growth rate. The resultant Background 2025 traffic volumes are shown in Figure 3.

Planned Roadway Improvement Project

In 2018, the cities of Homewood and Mountain Brook began efforts to modify the existing Hollywood Boulevard bridge over U.S. Highway 280 to add a pedestrian walkway. With additional funding from Jefferson County and the State of Alabama as well as private donors, the project is currently moving forward in the design process under the direction of Jefferson County Roads and Transportation. AECOM was hired in September, 2021 to prepare construction plans. The most current concept includes not only construction of a pedestrian walkway, but also widens the bridge to three travel lanes and installs a traffic signal at the east end of the bridge for traffic exiting the U.S. Highway 280 ramp. The conceptual plan is shown below. Expected bid letting is in August, 2022.



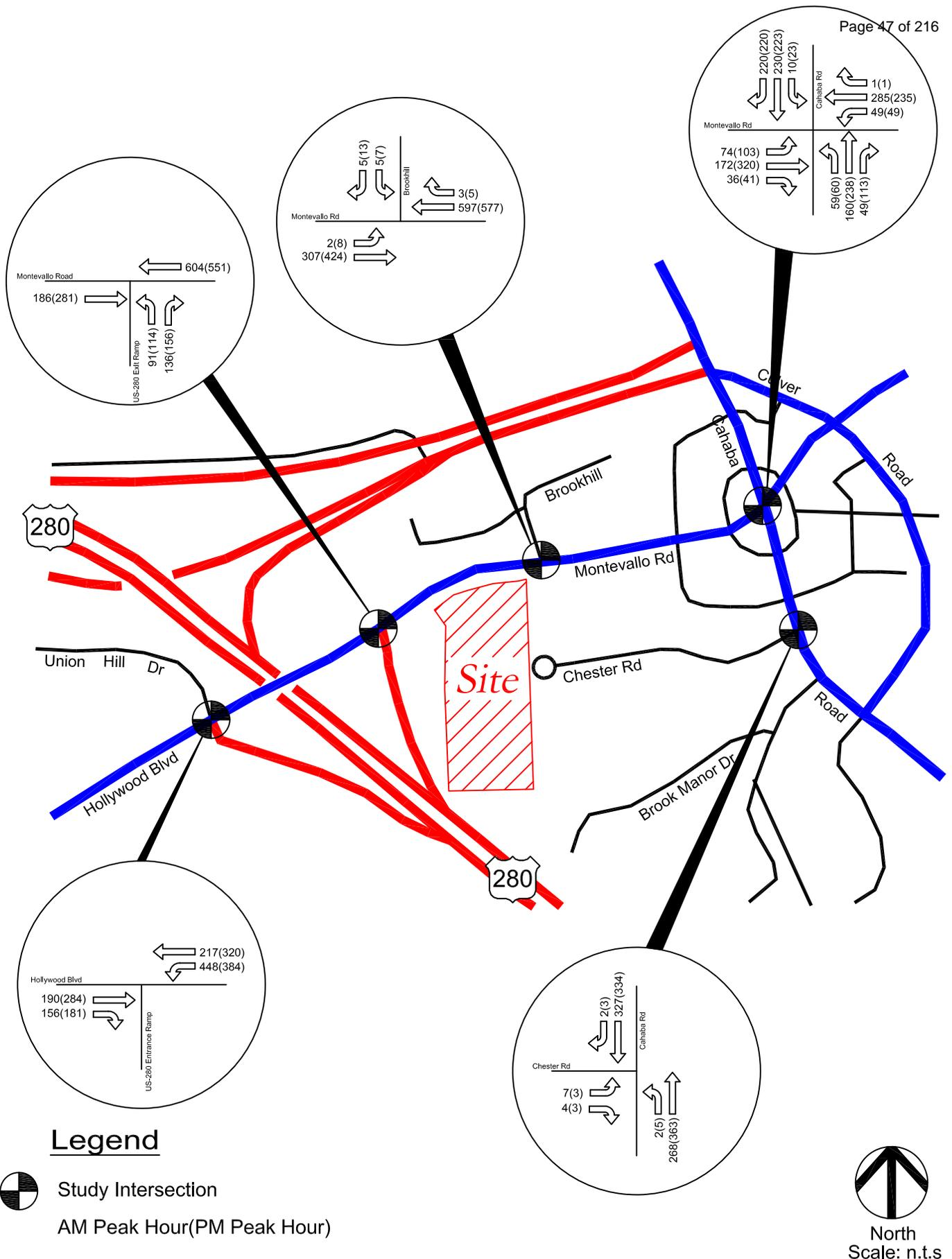

Background 2025 Intersection Capacity Analysis

Background 2025 a.m. and p.m. peak hour intersection capacity analyses were performed for the study intersections using the method of analysis included in the *Highway Capacity Manual*. The analyses include the proposed improvements documented in the previous section of this report. The results of the Background 2025 a.m. and p.m. peak hour intersection capacity analyses are included in Appendix E and are summarized in Table 4.

Table 4
Background 2025 Intersection Capacity Analysis

<i>Intersection</i>	<i>Approach</i>	<i>Movement</i>	<i>Level of Service</i>	
			<i>AM Peak</i>	<i>PM Peak</i>
Montevallo Road at US-280 Entrance Ramp	Montevallo Road Westbound	Left	A	A
Montevallo Road at US-280 Exit Ramp	Montevallo Road Eastbound	Through	A	A
	Montevallo Road Westbound	Through	A	A
	US-280 Exit Ramp Northbound	Left	B	B
		Right	B	B
		<i>Overall approach</i>	<i>B</i>	<i>B</i>
		Overall Intersection	A	A
Montevallo Road at Brookhill Condos	Montevallo Road Eastbound	Left	A	A
	Brookhill Southbound	Left-Right	C	C
Montevallo Road at Cahaba Road	Montevallo Road Eastbound	Left	B	B
		Through-Right	B	B
		<i>Overall approach</i>	<i>B</i>	<i>B</i>
	Montevallo Road Westbound	Left	A	B
		Through-Right	B	B
		<i>Overall approach</i>	<i>B</i>	<i>B</i>
	Cahaba Road Northbound	Left	A	A
		Through-Right	A	A
		<i>Overall approach</i>	<i>A</i>	<i>A</i>
	Cahaba Road Southbound	Left	A	A
		Through-Right	B	B
		<i>Overall approach</i>	<i>B</i>	<i>B</i>
		Overall intersection	B	B
Cahaba Road at Chester Road	Cahaba Road Northbound	Left	A	A
	Chester Road Eastbound	Left-Right	B	B

Trip Generation

The trip generation potential for the proposed development was estimated based on information contained in the Institute of Transportation Engineers publication *Trip Generation, 11th Edition*. The trip generation estimate for the proposed development is shown in Table 5.

**Table 5
Trip Generation**

Land Use	Size		ITE Code	Daily			AM Peak Hour			PM Peak Hour		
				In	Out	Total	In	Out	Total	In	Out	Total
Condominium	32	d.u.'s	220	108	108	216	3	10	13	10	6	16
Single Family	14	d.u.'s	210	83	83	166	3	9	12	10	6	16
Total				191	191	382	6	19	25	20	12	32

Directional Distribution

The directions of approach of traffic generated by the development was estimated based on existing patterns of traffic flow on the area roadways. The directional distribution is shown in Figure 4.

Future 2025 Traffic Volumes

Traffic projected to be generated by the proposed development during the a.m. and p.m. peak hours was assigned to the study intersections and site access points based on the directional distribution and access usage assumptions and was then added to Background 2025 traffic volumes. The resultant Future 2025 a.m. and p.m. peak hour traffic volume projections are shown in Figure 5.

Future 2025 Intersection Capacity Analysis

Future 2025 a.m. and p.m. peak hour intersection capacity analyses were performed for the study intersections using the method of analysis included in the *Highway Capacity Manual*. The results of the Future 2025 a.m. and p.m. peak hour intersection capacity analyses are included in Appendix F and are summarized in Table 6.

Recommendations

The findings of this report are that no roadway improvements are required to mitigate the traffic impacts of the proposed development. Levels of service remain unchanged from Background 2025 conditions to Future 2025 conditions with development traffic added. The proposed site access driveways can be constructed with two lane cross sections. No turn lanes are required at the site access points to provide adequate traffic operations.

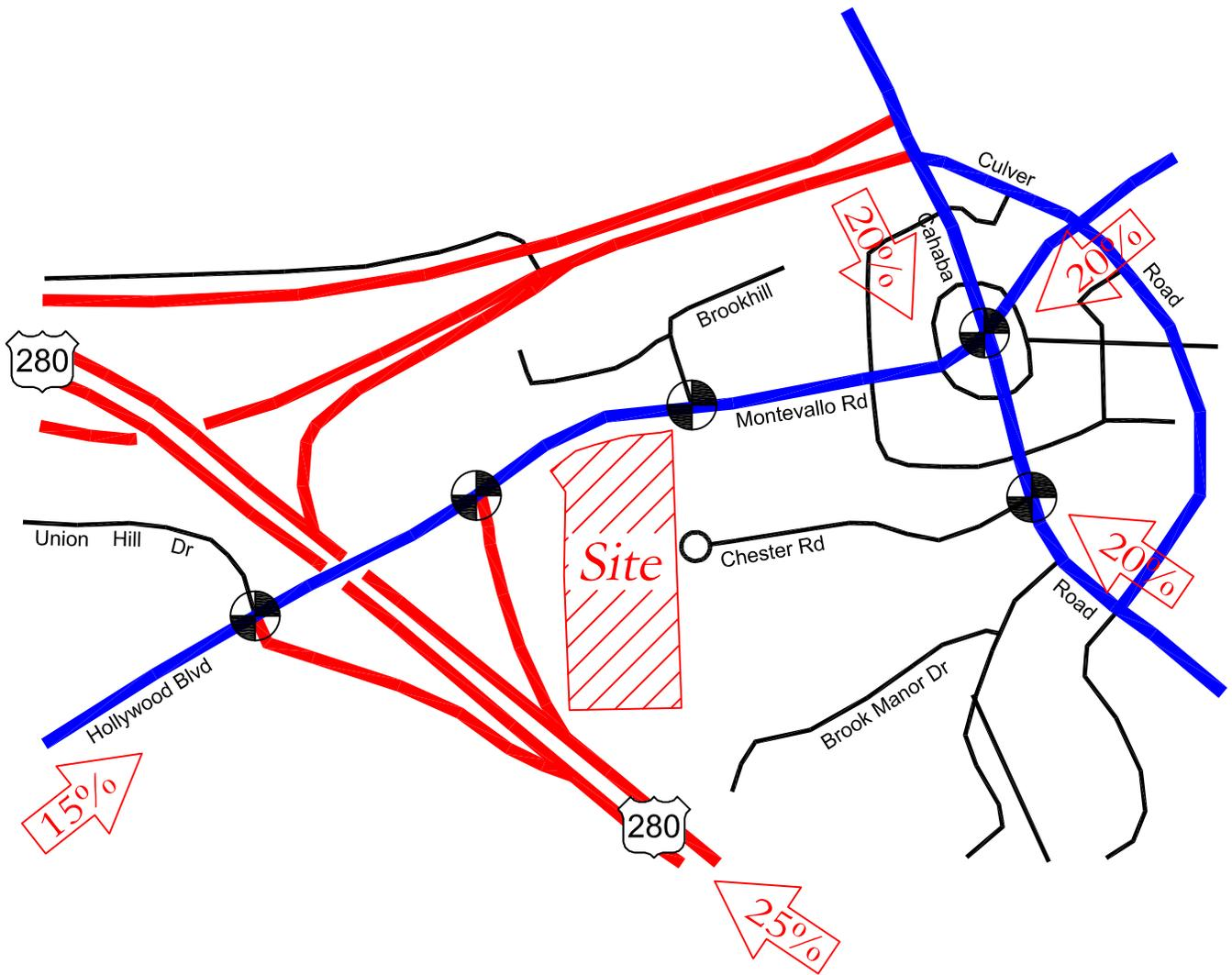

Legend

 Study Intersection



North
Scale: n.t.s



North
Scale: n.t.s

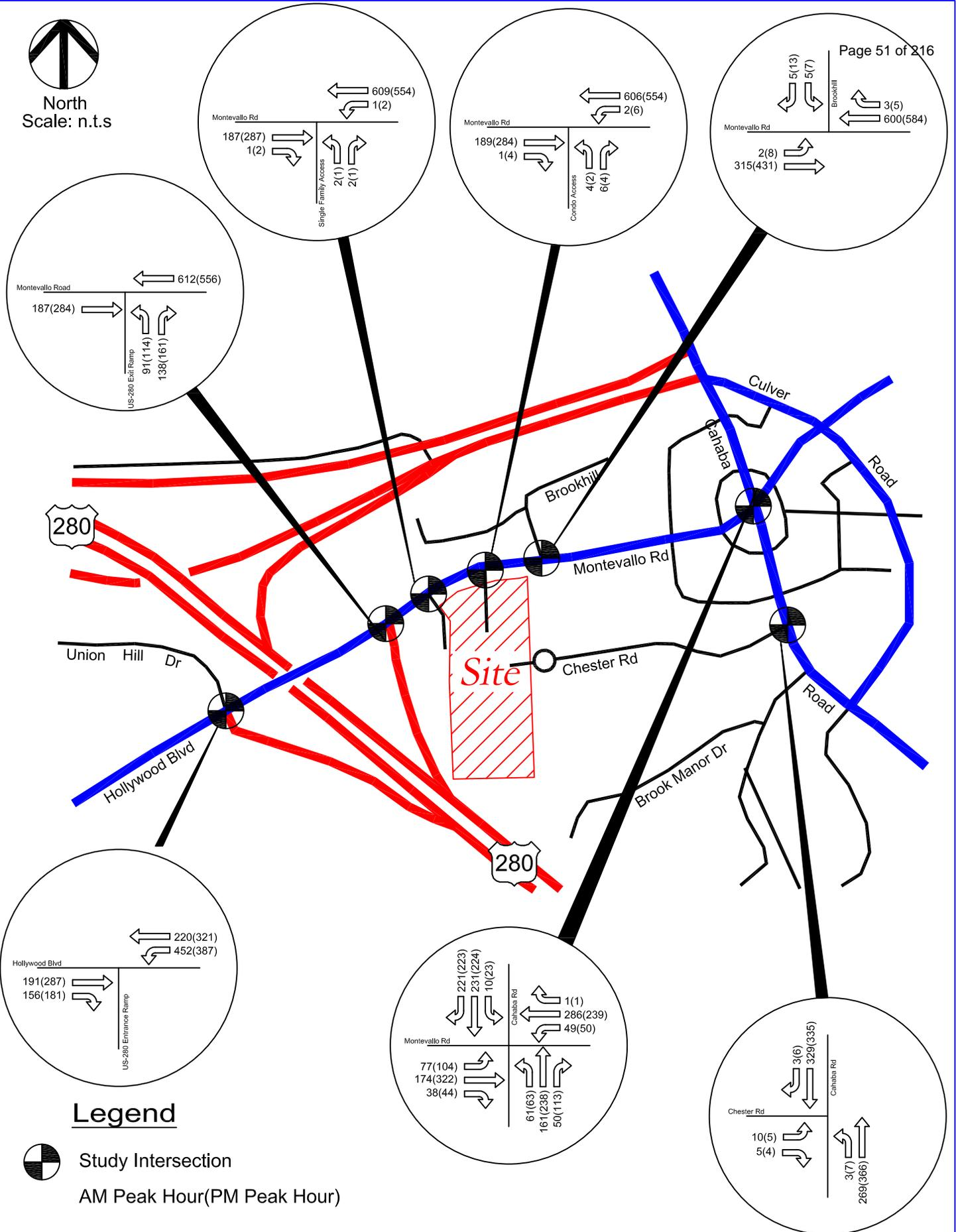
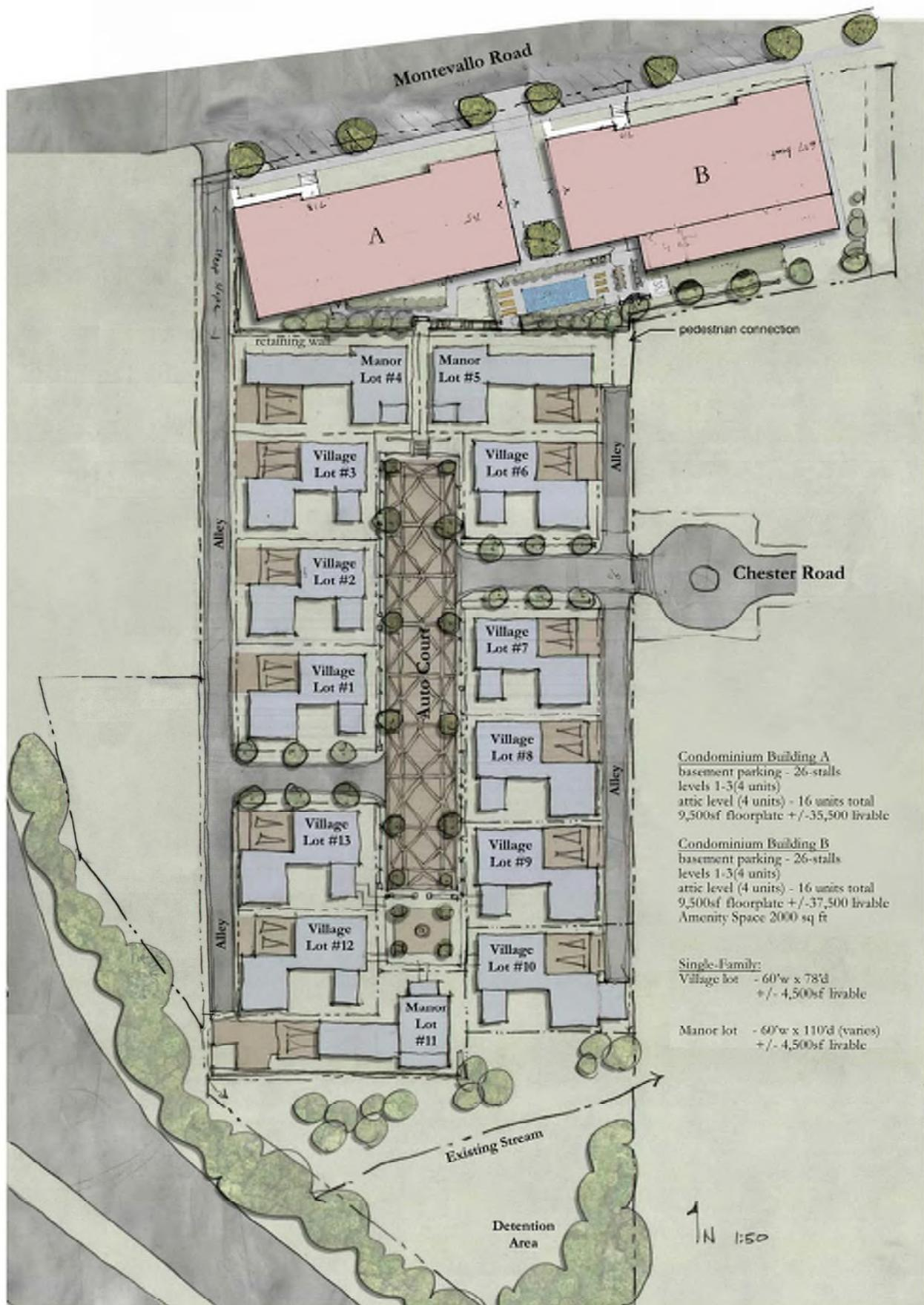

Table 6
Future 2025 Intersection Capacity Analysis

<i>Intersection</i>	<i>Approach</i>	<i>Movement</i>	<i>Level of Service</i>	
			<i>AM Peak</i>	<i>PM Peak</i>
Montevallo Road at US-280 Entrance Ramp	Montevallo Road Westbound	Left	A	A
Montevallo Road at US-280 Exit Ramp	Montevallo Road Eastbound	Through	A	A
	Montevallo Road Westbound	Through	A	A
	US-280 Exit Ramp Northbound	Left	B	B
		Right	B	B
	<i>Overall approach</i>		<i>B</i>	<i>B</i>
<i>Overall Intersection</i>		<i>A</i>	<i>A</i>	
Montevallo Road at Brookhill Condos	Montevallo Road Eastbound	Left	A	A
	Brookhill Southbound	Left-Right	C	C
Montevallo Road at Cahaba Road	Montevallo Road Eastbound	Left	B	B
		Through-Right	B	B
		<i>Overall approach</i>	<i>B</i>	<i>B</i>
	Montevallo Road Westbound	Left	A	B
		Through-Right	B	B
		<i>Overall approach</i>	<i>B</i>	<i>B</i>
	Cahaba Road Northbound	Left	A	A
		Through-Right	A	B
		<i>Overall approach</i>	<i>A</i>	<i>A</i>
	Cahaba Road Southbound	Left	A	A
		Through-Right	B	B
		<i>Overall approach</i>	<i>B</i>	<i>B</i>
<i>Overall intersection</i>		<i>B</i>	<i>B</i>	
Cahaba Road at Chester Road	Cahaba Road Northbound	Left	A	A
	Chester Road Eastbound	Left-Right	B	B
Montevallo Road at Single Family Access	Montevallo Road Westbound	Left-Through	A	A
	Site Access Northbound	Left-Right	B	B
Montevallo Road at Condo Access	Montevallo Road Westbound	Left-Through	A	A
	Site Access Northbound	Left-Right	B	B

Appendix A

Proposed Site Plan



Condominium Building A
 basement parking - 26-stalls
 levels 1-3(4 units) - 16 units total
 attic level (4 units) - 16 units total
 9,500sf floorplate +/-35,500 livable

Condominium Building B
 basement parking - 26-stalls
 levels 1-3(4 units) - 16 units total
 attic level (4 units) - 16 units total
 9,500sf floorplate +/-37,500 livable
 Amenity Space 2000 sq ft

Single-Family:
 Village lot - 60'w x 78'd
 +/- 4,500sf livable

Manor lot - 60'w x 110'd (varies)
 +/- 4,500sf livable

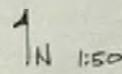

Appendix B

Existing Intersection Turning Movement Traffic Counts

TRAFFIC DATA, LLC

PO Box 187

Cullman, AL 35056

205-824-0125

Mountain Brook, AL

File Name : mountainbrook04

Site Code : 00000000

Start Date : 03/23/2022

Page No : 1

Groups Printed- Unshifted

Start Time	HOLLYWOOD BLVD Westbound		US 280 ON RAMP Northbound	HOLLYWOOD BLVD Eastbound		Int. Total
	Left	Thru	Thru	Thru	Right	
04:00 PM	109	55	0	58	51	273
04:15 PM	113	76	0	76	44	309
04:30 PM	81	71	0	56	45	253
04:45 PM	96	87	0	77	43	303
Total	399	289	0	267	183	1138
05:00 PM	88	81	0	71	46	286
05:15 PM	75	80	0	73	30	258
05:30 PM	85	92	0	67	39	283
05:45 PM	67	65	0	47	29	208
Total	315	318	0	258	144	1035
07:00 AM	65	32	0	39	24	160
07:15 AM	82	47	0	38	21	188
07:30 AM	102	49	0	38	44	233
07:45 AM	128	49	0	53	24	254
Total	377	177	0	168	113	835
08:00 AM	96	51	0	54	50	251
08:15 AM	115	65	0	42	36	258
08:30 AM	71	43	0	41	31	186
08:45 AM	110	62	0	58	34	264
Total	392	221	0	195	151	959
Grand Total	1483	1005	0	888	591	3967
Apprch %	59.6	40.4	0.0	60.0	40.0	
Total %	37.4	25.3	0.0	22.4	14.9	

Start Time	App. Total	HOLLYWOOD BLVD Westbound		App. Total	US 280 ON RAMP Northbound		HOLLYWOOD BLVD Eastbound			Int. Total
		Left	Thru		Thru	App. Total	Thru	Right	App. Total	
Peak Hour From 04:00 PM to 05:45 PM - Peak 1 of 1										
Intersection	04:15 PM									
Volume	0	378	315	693	0	0	280	178	458	1151
Percent		54.5	45.5		0.0		61.1	38.9		
04:15 Volume	0	113	76	189	0	0	76	44	120	309
Peak Factor										0.931
High Int.	3:45:00 PM	04:15 PM			3:45:00 PM		04:15 PM			
Volume	0	113	76	189	0	0	76	44	120	
Peak Factor				0.917					0.954	
Peak Hour From 04:00 PM to 05:45 PM - Peak 1 of 1										
By Approach	04:00 PM	04:15 PM			04:00 PM		04:15 PM			
Volume	0	378	315	693	0	0	280	178	458	
Percent		54.5	45.5		-		61.1	38.9		
High Int.	-	04:15 PM			-		04:15 PM			
Volume	-	113	76	189	-	-	76	44	120	
Peak Factor	-			0.917	-	-			0.954	

TRAFFIC DATA, LLC

PO Box 187
 Cullman, AL 35056
 205-824-0125

File Name : mountainbrook04
 Site Code : 00000000
 Start Date : 03/23/2022
 Page No : 2

Start Time	App. Total	HOLLYWOOD BLVD Westbound			US 280 ON RAMP Northbound			HOLLYWOOD BLVD Eastbound			Int. Total
		Left	Thru	App. Total	Thru	App. Total	Thru	Right	App. Total		
Peak Hour From 07:00 AM to 08:45 AM - Peak 1 of 1											
Intersection	07:30 AM										
Volume	0	441	214	655	0	0	187	154	341	996	
Percent		67.3	32.7		0.0		54.8	45.2			
08:15 Volume	0	115	65	180	0	0	42	36	78	258	
Peak Factor										0.965	
High Int.		08:15 AM					08:00 AM				
Volume	0	115	65	180	0	0	54	50	104		
Peak Factor				0.910					0.820		
Peak Hour From 07:00 AM to 08:45 AM - Peak 1 of 1											
By Approach	07:00 AM	07:30 AM			07:00 AM		08:00 AM				
Volume	0	441	214	655	0	0	195	151	346		
Percent		67.3	32.7		-		56.4	43.6			
High Int.	-	08:15 AM			-		08:00 AM				
Volume	-	115	65	180	-	-	54	50	104		
Peak Factor	-			0.910	-	-			0.832		

TRAFFIC DATA, LLC

PO Box 187

Cullman, AL 35056

205-824-0125

Mountain Brook, AL

File Name : mountainbrook03

Site Code : 00000000

Start Date : 03/23/2022

Page No : 1

Groups Printed- Unshifted

Start Time	BROOKHILL Southbound		MONTEVALLO RD Westbound		MONTEVALLO RD Eastbound		Int. Total
	Left	Right	Thru	Right	Left	Thru	
04:00 PM	2	1	140	5	0	85	233
04:15 PM	2	2	158	3	2	102	269
04:30 PM	3	0	133	0	2	84	222
04:45 PM	0	5	128	1	3	119	256
Total	7	8	559	9	7	390	980
05:00 PM	2	6	149	1	1	113	272
05:15 PM	4	0	117	2	2	105	230
05:30 PM	1	0	148	0	0	98	247
05:45 PM	1	0	110	3	0	86	200
Total	8	6	524	6	3	402	949
07:00 AM	2	2	90	0	1	51	146
07:15 AM	0	2	115	1	0	64	182
07:30 AM	0	1	147	0	0	73	221
07:45 AM	3	2	169	3	0	84	261
Total	5	7	521	4	1	272	810
08:00 AM	1	2	130	0	1	79	213
08:15 AM	1	0	142	0	1	66	210
08:30 AM	3	0	96	1	1	71	172
08:45 AM	1	1	133	1	2	100	238
Total	6	3	501	2	5	316	833
Grand Total	26	24	2105	21	16	1380	3572
Apprch %	52.0	48.0	99.0	1.0	1.1	98.9	
Total %	0.7	0.7	58.9	0.6	0.4	38.6	

Start Time	BROOKHILL Southbound			MONTEVALLO RD Westbound			MONTEVALLO RD Eastbound			Int. Total
	Left	Right	App. Total	Thru	Right	App. Total	App. Total	Left	Thru	
Peak Hour From 04:00 PM to 05:45 PM - Peak 1 of 1										
Intersection	04:15 PM									
Volume	7	13	20	568	5	573	0	8	418	426
Percent	35.0	65.0		99.1	0.9			1.9	98.1	
05:00 Volume	2	6	8	149	1	150	0	1	113	114
Peak Factor										0.937
High Int.	05:00 PM			04:15 PM			3:45:00 PM	04:45 PM		
Volume	2	6	8	158	3	161	0	3	119	122
Peak Factor			0.625			0.890				0.873
Peak Hour From 04:00 PM to 05:45 PM - Peak 1 of 1										
By Approach	04:15 PM			04:15 PM			04:00 PM	04:45 PM		
Volume	7	13	20	568	5	573	0	6	435	441
Percent	35.0	65.0		99.1	0.9			1.4	98.6	
High Int.	05:00 PM			04:15 PM			-	04:45 PM		
Volume	2	6	8	158	3	161	-	3	119	122
Peak Factor			0.625			0.890	-			0.904

TRAFFIC DATA, LLC

PO Box 187
 Cullman, AL 35056
 205-824-0125

File Name : mountainbrook03
 Site Code : 00000000
 Start Date : 03/23/2022
 Page No : 2

Start Time	BROOKHILL Southbound			MONTEVALLO RD Westbound			App. Total	MONTEVALLO RD Eastbound			Int. Total	
	Left	Right	App. Total	Thru	Right	App. Total		Left	Thru	App. Total		
Peak Hour From 07:00 AM to 08:45 AM - Peak 1 of 1												
Intersection	07:30 AM											
Volume	5	5	10	588	3	591	0	2	302	304	905	
Percent	50.0	50.0		99.5	0.5			0.7	99.3			
07:45 Volume	3	2	5	169	3	172	0	0	84	84	261	
Peak Factor											0.867	
High Int.	07:45 AM			07:45 AM				07:45 AM				
Volume	3	2	5	169	3	172	0	0	84	84		
Peak Factor	0.500			0.859				0.905				
Peak Hour From 07:00 AM to 08:45 AM - Peak 1 of 1												
By Approach	07:00 AM			07:30 AM			07:00 AM		08:00 AM			
Volume	5	7	12	588	3	591	0	5	318	321		
Percent	41.7	58.3		99.5	0.5			1.6	98.4			
High Int.	07:45 AM			07:45 AM					08:45 AM			
Volume	3	2	5	169	3	172	-	2	100	102		
Peak Factor	0.600			0.859			-		0.787			

TRAFFIC DATA, LLC

PO Box 187

Cullman, AL 35056

205-824-0125

Mountain Brook, AL

File Name : mountainbrook02

Site Code : 00000000

Start Date : 03/23/2022

Page No : 1

Groups Printed- Unshifted

Start Time	CAHABA RD Southbound			MONTEVALLO RD Westbound			CAHABA RD Northbound			MONTEVALLO RD Eastbound			Int. Total
	Left	Thru	Right	Left	Thru	Right	Left	Thru	Right	Left	Thru	Right	
04:00 PM	4	47	57	4	58	1	19	53	38	26	55	12	374
04:15 PM	8	38	55	7	75	0	17	53	23	26	61	10	373
04:30 PM	10	57	49	16	49	1	14	53	27	23	59	6	364
04:45 PM	6	58	42	15	65	1	19	65	17	20	90	12	410
Total	28	200	203	42	247	3	69	224	105	95	265	40	1521
05:00 PM	4	41	53	14	53	0	18	66	28	26	79	11	393
05:15 PM	11	60	59	7	45	0	10	60	34	31	70	7	394
05:30 PM	2	61	63	12	69	0	12	43	32	24	76	10	404
05:45 PM	4	54	33	5	59	0	10	46	31	19	60	7	328
Total	21	216	208	38	226	0	50	215	125	100	285	35	1519
07:00 AM	1	16	27	7	45	0	6	17	7	6	33	3	168
07:15 AM	1	40	27	8	71	0	10	27	5	16	30	6	241
07:30 AM	3	60	58	8	74	0	12	48	15	15	42	7	342
07:45 AM	3	46	61	15	84	0	14	43	15	18	50	15	364
Total	8	162	173	38	274	0	42	135	42	55	155	31	1115
08:00 AM	3	61	45	13	65	0	15	33	8	23	45	7	318
08:15 AM	1	60	53	12	68	1	17	34	10	17	32	6	311
08:30 AM	0	42	27	15	52	0	9	35	11	17	43	5	256
08:45 AM	0	47	50	14	64	1	8	31	12	28	49	10	314
Total	4	210	175	54	249	2	49	133	41	85	169	28	1199
Grand Total	61	788	759	172	996	5	210	707	313	335	874	134	5354
Apprch %	3.8	49.0	47.2	14.7	84.9	0.4	17.1	57.5	25.4	24.9	65.1	10.0	
Total %	1.1	14.7	14.2	3.2	18.6	0.1	3.9	13.2	5.8	6.3	16.3	2.5	

Start Time	CAHABA RD Southbound				MONTEVALLO RD Westbound				CAHABA RD Northbound				MONTEVALLO RD Eastbound				Int. Total
	Left	Thru	Right	App. Total	Left	Thru	Right	App. Total	Left	Thru	Right	App. Total	Left	Thru	Right	App. Total	
Peak Hour From 04:00 PM to 05:45 PM - Peak 1 of 1																	
Intersection	04:45 PM				04:45 PM				05:00 PM				04:45 PM				0.976
Volume	23	220	217	460	48	232	1	281	59	234	111	404	101	315	40	456	
Percent	5.0	47.8	47.2		17.1	82.6	0.4		14.6	57.9	27.5		22.1	69.1	8.8		
04:45	04:45 PM				04:45 PM				05:00 PM				04:45 PM				0.934
Volume	6	58	42	106	15	65	1	81	19	65	17	101	20	90	12	122	
Peak Factor	0.885				0.867				0.902				0.934				
High Int.	05:15 PM				04:45 PM				05:00 PM				04:45 PM				
Volume	11	60	59	130	15	65	1	81	18	66	28	112	20	90	12	122	
Peak Factor	0.885				0.867				0.902				0.934				
Peak Hour From 04:00 PM to 05:45 PM - Peak 1 of 1																	
By Approach	04:45 PM				04:15 PM				04:30 PM				04:45 PM				
Volume	23	220	217	460	52	242	2	296	61	244	106	411	101	315	40	456	
Percent	5.0	47.8	47.2		17.6	81.8	0.7		14.8	59.4	25.8		22.1	69.1	8.8		
High Int.	05:15 PM				04:15 PM				05:00 PM				04:45 PM				
Volume	11	60	59	130	7	75	0	82	18	66	28	112	20	90	12	122	
Peak Factor	0.885				0.902				0.917				0.934				

TRAFFIC DATA, LLC

PO Box 187
Cullman, AL 35056
205-824-0125

File Name : mountainbrook02
Site Code : 00000000
Start Date : 03/23/2022
Page No : 2

Start Time	CAHABA RD Southbound				MONTEVALLO RD Westbound				CAHABA RD Northbound				MONTEVALLO RD Eastbound				Int. Total
	Left	Thru	Right	App. Total	Left	Thru	Right	App. Total	Left	Thru	Right	App. Total	Left	Thru	Right	App. Total	
Peak Hour From 07:00 AM to 08:45 AM - Peak 1 of 1																	
Intersection	07:30 AM				07:45 AM				07:30 AM				07:45 AM				
Volume	10	227	217	454	48	291	1	340	58	158	48	264	73	169	35	277	1335
Percent	2.2	50.0	47.8		14.1	85.6	0.3		22.0	59.8	18.2		26.4	61.0	12.6		
07:45																	
Volume	3	46	61	110	15	84	0	99	14	43	15	72	18	50	15	83	364
Peak Factor																	0.917
High Int.	07:30 AM				07:45 AM				07:30 AM				07:45 AM				
Volume	3	60	58	121	15	84	0	99	12	48	15	75	18	50	15	83	
Peak Factor	0.938				0.859				0.880				0.834				
Peak Hour From 07:00 AM to 08:45 AM - Peak 1 of 1																	
By Approach	07:30 AM				07:30 AM				07:30 AM				08:00 AM				
Volume	10	227	217	454	48	291	1	340	58	158	48	264	85	169	28	282	
Percent	2.2	50.0	47.8		14.1	85.6	0.3		22.0	59.8	18.2		30.1	59.9	9.9		
High Int.	07:30 AM				07:45 AM				07:30 AM				08:45 AM				
Volume	3	60	58	121	15	84	0	99	12	48	15	75	28	49	10	87	
Peak Factor	0.938				0.859				0.880				0.810				

TRAFFIC DATA, LLC

PO Box 187

Cullman, AL 35056

205-824-0125

Mountain Brook, AL

File Name : mountainbrook05

Site Code : 00000000

Start Date : 03/23/2022

Page No : 1

Groups Printed- 1 - Unshifted

Start Time	CAHABA RD Southbound		CAHABA RD Northbound		CHESTER RD Eastbound		Int. Total
	Thru	Right	Left	Thru	Left	Right	
04:00 PM	64	1	0	97	4	1	167
04:15 PM	51	0	1	93	0	2	147
04:30 PM	77	0	1	80	1	2	161
04:45 PM	85	0	1	99	0	1	186
Total	277	1	3	369	5	6	661
05:00 PM	70	2	1	103	2	0	178
05:15 PM	81	1	2	89	1	1	175
05:30 PM	93	0	1	67	0	1	162
05:45 PM	75	0	0	84	1	1	161
Total	319	3	4	343	4	3	676
07:00 AM	29	0	0	23	1	0	53
07:15 AM	56	0	0	42	0	0	98
07:30 AM	80	0	1	81	0	1	163
07:45 AM	82	1	0	70	2	1	156
Total	247	1	1	216	3	2	470
08:00 AM	80	1	1	63	5	1	151
08:15 AM	80	0	0	50	0	1	131
08:30 AM	64	0	1	48	1	1	115
08:45 AM	75	0	1	51	2	0	129
Total	299	1	3	212	8	3	526
Grand Total	1142	6	11	1140	20	14	2333
Apprch %	99.5	0.5	1.0	99.0	58.8	41.2	
Total %	48.9	0.3	0.5	48.9	0.9	0.6	

Start Time	CAHABA RD Southbound			App. Total	CAHABA RD Northbound			App. Total	CHESTER RD Eastbound			Int. Total
	Thru	Right	App. Total		Left	Thru	App. Total		Left	Right	App. Total	
Peak Hour From 04:00 PM to 05:45 PM - Peak 1 of 1												
Intersection	04:45 PM											
Volume	329	3	332	0	5	358	363		3	3	6	701
Percent	99.1	0.9			1.4	98.6			50.0	50.0		
04:45 Volume	85	0	85	0	1	99	100		0	1	1	186
Peak Factor												0.942
High Int.	05:30 PM			3:45:00 PM	05:00 PM				05:00 PM			
Volume	93	0	93	0	1	103	104		2	0	2	
Peak Factor	0.892				0.873				0.750			
Peak Hour From 04:00 PM to 05:45 PM - Peak 1 of 1												
By Approach	04:45 PM			04:00 PM	04:15 PM				04:00 PM			
Volume	329	3	332	0	4	375	379		5	6	11	
Percent	99.1	0.9			1.1	98.9			45.5	54.5		
High Int.	05:30 PM			-	05:00 PM				04:00 PM			
Volume	93	0	93	-	1	103	104		4	1	5	
Peak Factor	0.892			-	0.911				0.550			

TRAFFIC DATA, LLC

PO Box 187
 Cullman, AL 35056
 205-824-0125

File Name : mountainbrook05
 Site Code : 00000000
 Start Date : 03/23/2022
 Page No : 2

Start Time	CAHABA RD Southbound			App. Total	CAHABA RD Northbound			CHESTER RD Eastbound			Int. Total
	Thru	Right	App. Total		Left	Thru	App. Total	Left	Right	App. Total	
Peak Hour From 07:00 AM to 08:45 AM - Peak 1 of 1											
Intersection	07:30 AM										
Volume	322	2	324	0	2	264	266	7	4	11	601
Percent	99.4	0.6			0.8	99.2		63.6	36.4		
07:30 Volume	80	0	80	0	1	81	82	0	1	1	163
Peak Factor											0.922
High Int.	07:45 AM				07:30 AM			08:00 AM			
Volume	82	1	83	0	1	81	82	5	1	6	
Peak Factor			0.976				0.811			0.458	
Peak Hour From 07:00 AM to 08:45 AM - Peak 1 of 1											
By Approach	07:30 AM			07:00 AM	07:30 AM			07:45 AM			
Volume	322	2	324	0	2	264	266	8	4	12	
Percent	99.4	0.6			0.8	99.2		66.7	33.3		
High Int.	07:45 AM			-	07:30 AM			08:00 AM			
Volume	82	1	83	-	1	81	82	5	1	6	
Peak Factor			0.976	-			0.811			0.500	

TRAFFIC DATA, LLC

PO Box 187

Cullman, AL 35056

205-824-0125

Mountain Brook, AL

File Name : mountainbrook01

Site Code : 00000000

Start Date : 03/23/2022

Page No : 1

Groups Printed- Unshifted

Start Time	ORTHODONTICS Southbound			HOLLYWOOD BLVD Westbound			US 280 EXIT RAMP Northbound			HOLLYWOOD BLVD Eastbound			Int. Total
	Left	Thru	Right	Left	Thru	Right	Left	Thru	Right	Left	Thru	Right	
04:00 PM	0	0	0	0	140	0	22	0	32	0	56	0	250
04:15 PM	0	0	3	0	159	1	26	0	32	0	68	0	289
04:30 PM	1	0	1	0	130	1	21	0	35	1	50	0	240
04:45 PM	0	0	2	0	132	0	35	1	38	0	76	0	284
Total	1	0	6	0	561	2	104	1	137	1	250	0	1063
05:00 PM	0	0	0	0	144	0	20	0	43	0	66	0	273
05:15 PM	0	0	0	0	120	0	30	0	33	0	76	0	259
05:30 PM	0	0	0	0	147	0	27	0	40	0	59	0	273
05:45 PM	0	0	0	0	112	0	25	0	38	0	49	0	224
Total	0	0	0	0	523	0	102	0	154	0	250	0	1029
07:00 AM	0	0	0	0	89	0	16	0	17	0	36	0	158
07:15 AM	0	0	0	0	119	0	14	0	32	0	34	0	199
07:30 AM	1	0	0	0	148	0	21	0	38	0	35	0	243
07:45 AM	0	0	0	0	165	1	19	0	36	0	52	0	273
Total	1	0	0	0	521	1	70	0	123	0	157	0	873
08:00 AM	0	0	1	0	136	0	22	0	32	0	51	0	242
08:15 AM	0	0	0	0	146	0	28	0	28	0	45	0	247
08:30 AM	0	0	0	0	94	0	19	0	30	0	37	0	180
08:45 AM	1	0	0	0	131	0	46	0	46	1	52	0	277
Total	1	0	1	0	507	0	115	0	136	1	185	0	946
Grand Total	3	0	7	0	2112	3	391	1	550	2	842	0	3911
Apprch %	30.0	0.0	70.0	0.0	99.9	0.1	41.5	0.1	58.4	0.2	99.8	0.0	
Total %	0.1	0.0	0.2	0.0	54.0	0.1	10.0	0.0	14.1	0.1	21.5	0.0	

Start Time	ORTHODONTICS Southbound				HOLLYWOOD BLVD Westbound				US 280 EXIT RAMP Northbound				HOLLYWOOD BLVD Eastbound				Int. Total
	Left	Thru	Right	App. Total	Left	Thru	Right	App. Total	Left	Thru	Right	App. Total	Left	Thru	Right	App. Total	
Peak Hour From 04:00 PM to 05:45 PM - Peak 1 of 1																	
Intersection	04:45 PM				05:30 PM				04:45 PM				04:45 PM				
Volume	0	0	2	2	0	543	0	543	112	1	154	267	0	277	0	277	1089
Percent	0.0	0.0	100.0		0.0	100.0	0.0		41.9	0.4	57.7		0.0	100.0	0.0		
04:45	0	0	2	2	0	132	0	132	35	1	38	74	0	76	0	76	284
Volume																	0.959
Peak Factor	0.250				0.923				0.902				0.911				
High Int.	04:45 PM				05:30 PM				04:45 PM				04:45 PM				
Volume	0	0	2	2	0	147	0	147	35	1	38	74	0	76	0	76	
Peak Factor	0.250				0.923				0.902				0.911				
Peak Hour From 04:00 PM to 05:45 PM - Peak 1 of 1																	
By Approach	04:00 PM				04:15 PM				04:45 PM				04:45 PM				
Volume	1	0	6	7	0	565	2	567	112	1	154	267	0	277	0	277	
Percent	14.3	0.0	85.7		0.0	99.6	0.4		41.9	0.4	57.7		0.0	100.0	0.0		
High Int.	04:15 PM				04:15 PM				04:45 PM				04:45 PM				
Volume	0	0	3	3	0	159	1	160	35	1	38	74	0	76	0	76	
Peak Factor	0.583				0.886				0.902				0.911				

TRAFFIC DATA, LLC

PO Box 187
Cullman, AL 35056
205-824-0125

File Name : mountainbrook01
Site Code : 00000000
Start Date : 03/23/2022
Page No : 2

Start Time	ORTHODONTICS Southbound				HOLLYWOOD BLVD Westbound				US 280 EXIT RAMP Northbound				HOLLYWOOD BLVD Eastbound				Int. Total
	Left	Thru	Right	App. Total	Left	Thru	Right	App. Total	Left	Thru	Right	App. Total	Left	Thru	Right	App. Total	
Peak Hour From 07:00 AM to 08:45 AM - Peak 1 of 1																	
Intersection	07:30 AM																
Volume	1	0	1	2	0	595	1	596	90	0	134	224	0	183	0	183	1005
Percent	50.0	0.0	50.0		0.0	99.8	0.2		40.2	0.0	59.8		0.0	100.0	0.0		
07:45																	
Volume	0	0	0	0	0	165	1	166	19	0	36	55	0	52	0	52	273
Peak Factor																	0.920
High Int.	07:30 AM				07:45 AM				07:30 AM				07:45 AM				
Volume	1	0	0	1	0	165	1	166	21	0	38	59	0	52	0	52	
Peak Factor	0.500								0.898				0.949				0.880
Peak Hour From 07:00 AM to 08:45 AM - Peak 1 of 1																	
By Approach	07:15 AM				07:30 AM				08:00 AM				08:00 AM				
Volume	1	0	1	2	0	595	1	596	115	0	136	251	1	185	0	186	
Percent	50.0	0.0	50.0		0.0	99.8	0.2		45.8	0.0	54.2		0.5	99.5	0.0		
High Int.	07:30 AM				07:45 AM				08:45 AM				08:45 AM				
Volume	1	0	0	1	0	165	1	166	46	0	46	92	1	52	0	53	
Peak Factor	0.500								0.898				0.682				0.877

Appendix C

Machine Traffic Counts

TRAFFIC DATA, LLC
 PO Box 187, Cullman, AL 35056
 205-824-0125

Location: MONTEVALLO RD west of BROOKHILL
 City, State: MOUNTAIN BROOK, AL

Date: 3/23/2022
 Wednesday

24 Hour Volume

Begin	EB	WB	Combined	Begin	EB	WB	Combined
3:00 PM	108	149	634	3:00 AM	0	1	1
3:15 PM	91	171	262	3:15 AM	1	1	2
3:30 PM	99	155	254	3:30 AM	0	1	1
3:45 PM	80	159	239	3:45 AM	0	3	3
4:00 PM	98	134	545	4:00 AM	4	13	4
4:15 PM	101	158	259	4:15 AM	5	3	8
4:30 PM	96	123	219	4:30 AM	2	5	7
4:45 PM	118	130	248	4:45 AM	2	2	4
5:00 PM	113	146	259	5:00 AM	9	53	4
5:15 PM	113	130	243	5:15 AM	15	14	29
5:30 PM	102	136	238	5:30 AM	11	14	25
5:45 PM	85	109	194	5:45 AM	18	29	47
6:00 PM	80	118	419	6:00 AM	19	111	27
6:15 PM	79	112	191	6:15 AM	29	54	83
6:30 PM	60	106	166	6:30 AM	21	45	66
6:45 PM	69	83	152	6:45 AM	42	59	101
7:00 PM	50	70	278	7:00 AM	51	277	92
7:15 PM	50	85	135	7:15 AM	62	118	180
7:30 PM	45	56	101	7:30 AM	76	137	213
7:45 PM	39	67	106	7:45 AM	88	171	259
8:00 PM	53	56	242	8:00 AM	85	323	219
8:15 PM	49	79	128	8:15 AM	65	143	208
8:30 PM	25	59	84	8:30 AM	75	100	175
8:45 PM	37	48	85	8:45 AM	98	123	221
9:00 PM	28	46	152	9:00 AM	85	343	202
9:15 PM	20	53	73	9:15 AM	75	119	194
9:30 PM	13	22	35	9:30 AM	83	120	203
9:45 PM	7	31	38	9:45 AM	100	121	221
10:00 PM	9	14	23	10:00 AM	98	379	206
10:15 PM	3	26	29	10:15 AM	90	117	207
10:30 PM	11	10	21	10:30 AM	89	129	218
10:45 PM	4	8	12	10:45 AM	102	133	235
11:00 PM	2	10	12	11:00 AM	106	410	220
11:15 PM	1	4	5	11:15 AM	105	154	259
11:30 PM	2	7	9	11:30 AM	107	144	251
11:45 PM	1	4	5	11:45 AM	92	166	258
12:00 AM	0	4	8	12:00 PM	98	399	252
12:15 AM	0	2	2	12:15 PM	92	154	255
12:30 AM	4	3	7	12:30 PM	85	142	227
12:45 AM	0	2	2	12:45 PM	124	152	276
1:00 AM	0	3	3	1:00 PM	98	415	278
1:15 AM	1	0	1	1:15 PM	119	185	304
1:30 AM	0	1	1	1:30 PM	107	136	243
1:45 AM	0	2	2	1:45 PM	91	173	264
2:00 AM	0	3	3	2:00 PM	102	393	278
2:15 AM	0	1	1	2:15 PM	89	149	238
2:30 AM	0	0	0	2:30 PM	106	161	267
2:45 AM	0	3	3	2:45 PM	96	144	240
24 Hour Volume				24 Hour Volume			
EB 5063 (39.9%)				WB 7632 (60.1%)			
WB 7632 (60.1%)				EB 5063 (39.9%)			

12:00 AM - 12:00 PM

Count	Peak Hour	Volume	Factor	EB	WB	Combined
1915	10:45 AM	420	0.98	3148	4789	7937
40.2 %	7:30 AM	585	0.86	39.7 %	60.3 %	60.3 %
420	11:00 AM	988	0.95	12:45 PM	1:00 PM	12:45 PM
0.98	7:30 AM	585	0.86	448	674	1101
				0.90	0.91	0.91

TRAFFIC DATA, LLC
 PO Box 187, Cullman, AL 35056
 205-824-0125

Location: CAHABA RD north of CHESTER RD
 City, State: MOUNTAIN BROOK, AL

Date: 3/23/2022
 Wednesday

24 Hour Volume

Begin	NB	SB	Combined	Begin	NB	SB	Combined
3:00 PM	105	406	281	3:00 AM	1	2	3
3:15 PM	82	80	176	3:15 AM	0	0	0
3:30 PM	100	69	169	3:30 AM	0	1	1
3:45 PM	119	61	180	3:45 AM	1	2	3
4:00 PM	104	405	291	4:00 AM	1	0	1
4:15 PM	100	56	156	4:15 AM	4	6	10
4:30 PM	89	82	171	4:30 AM	2	2	4
4:45 PM	112	88	200	4:45 AM	2	2	4
5:00 PM	118	391	322	5:00 AM	5	17	22
5:15 PM	95	81	176	5:15 AM	4	3	7
5:30 PM	87	99	186	5:30 AM	3	6	9
5:45 PM	91	75	166	5:45 AM	5	8	13
6:00 PM	79	285	178	6:00 AM	8	62	70
6:15 PM	65	49	114	6:15 AM	16	15	31
6:30 PM	75	47	122	6:30 AM	14	24	38
6:45 PM	66	29	95	6:45 AM	24	19	43
7:00 PM	65	203	139	7:00 AM	29	215	244
7:15 PM	57	48	105	7:15 AM	39	59	98
7:30 PM	48	26	74	7:30 AM	76	82	158
7:45 PM	43	33	76	7:45 AM	71	89	160
8:00 PM	33	107	102	8:00 AM	57	95	152
8:15 PM	38	23	61	8:15 AM	54	92	146
8:30 PM	20	27	47	8:30 AM	46	63	109
8:45 PM	16	24	40	8:45 AM	50	79	129
9:00 PM	25	72	58	9:00 AM	61	80	141
9:15 PM	23	15	38	9:15 AM	64	61	125
9:30 PM	14	12	26	9:30 AM	81	83	164
9:45 PM	10	8	18	9:45 AM	57	72	129
10:00 PM	19	38	24	10:00 AM	61	277	338
10:15 PM	10	2	12	10:15 AM	72	52	124
10:30 PM	4	4	8	10:30 AM	65	62	127
10:45 PM	5	6	11	10:45 AM	79	85	164
11:00 PM	3	4	7	11:00 AM	73	398	471
11:15 PM	0	3	3	11:15 AM	97	92	189
11:30 PM	0	1	1	11:30 AM	114	70	184
11:45 PM	1	0	1	11:45 AM	114	83	197
12:00 AM	0	2	2	12:00 PM	102	420	522
12:15 AM	2	3	5	12:15 PM	101	74	175
12:30 AM	0	0	0	12:30 PM	89	89	178
12:45 AM	0	0	0	12:45 PM	115	103	218
1:00 AM	0	2	2	1:00 PM	85	80	165
1:15 AM	0	0	0	1:15 PM	90	115	205
1:30 AM	1	0	1	1:30 PM	96	79	175
1:45 AM	1	0	1	1:45 PM	93	78	171
2:00 AM	0	0	0	2:00 PM	95	385	480
2:15 AM	0	0	0	2:15 PM	83	83	166
2:30 AM	0	0	0	2:30 PM	81	83	164
2:45 AM	0	0	0	2:45 PM	110	69	179
				Combined	8556		

24 Hour Volume

NB	SB	Combined
4534 (53.0%)	4022 (47.0%)	8556
12:00 AM - 12:00 PM		
NB 1454	SB 1595	Combined 3049
47.7%	52.3%	
11:00 AM	7:30 AM	11:00 AM
398	358	726
0.87	0.94	0.92
12:00 PM - 12:00 AM		
NB 3080	SB 2427	Combined 5507
55.9%	44.1%	
3:30 PM	12:30 PM	12:30 PM
423	387	779
0.89	0.84	0.89

Appendix D

Existing Intersection Capacity Analysis Worksheets

HCM Unsignalized Intersection Capacity Analysis

1: US-280 Entrance Ramp & Hollywood Blvd

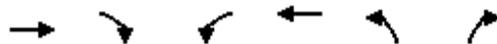

Movement	EBT	EBR	WBL	WBT	NBL	NBR
Lane Configurations	↔			↔		
Traffic Volume (veh/h)	187	154	441	214	0	0
Future Volume (Veh/h)	187	154	441	214	0	0
Sign Control	Free			Free	Stop	
Grade	0%			0%	0%	
Peak Hour Factor	0.82	0.82	0.91	0.91	0.92	0.92
Hourly flow rate (vph)	228	188	485	235	0	0
Pedestrians						
Lane Width (ft)						
Walking Speed (ft/s)						
Percent Blockage						
Right turn flare (veh)						
Median type	None		None			
Median storage (veh)						
Upstream signal (ft)						
pX, platoon unblocked						
vC, conflicting volume			228		1527	322
vC1, stage 1 conf vol						
vC2, stage 2 conf vol						
vCu, unblocked vol			228		1527	322
tC, single (s)			4.1		6.4	6.2
tC, 2 stage (s)						
tF (s)			2.2		3.5	3.3
p0 queue free %			63		100	100
cM capacity (veh/h)			1328		81	714
Direction, Lane #						
	EB 1	WB 1				
Volume Total	416	720				
Volume Left	0	485				
Volume Right	188	0				
cSH	1700	1328				
Volume to Capacity	0.24	0.37				
Queue Length 95th (ft)	0	42				
Control Delay (s)	0.0	7.5				
Lane LOS			A			
Approach Delay (s)	0.0	7.5				
Approach LOS						
Intersection Summary						
Average Delay			4.8			
Intersection Capacity Utilization			61.6%	ICU Level of Service	B	
Analysis Period (min)			15			

HCM Unsignalized Intersection Capacity Analysis

2: US-280 Exit Ramp & Hollywood Blvd/Montevallo Road



Movement	EBT	EBR	WBL	WBT	NBL	NBR
Lane Configurations	↑			↑	↘	↘
Traffic Volume (veh/h)	183	0	0	595	90	134
Future Volume (Veh/h)	183	0	0	595	90	134
Sign Control	Free			Free	Stop	
Grade	0%			0%	0%	
Peak Hour Factor	0.88	0.88	0.90	0.90	0.95	0.95
Hourly flow rate (vph)	208	0	0	661	95	141
Pedestrians						
Lane Width (ft)						
Walking Speed (ft/s)						
Percent Blockage						
Right turn flare (veh)						
Median type	None			None		
Median storage (veh)						
Upstream signal (ft)						
pX, platoon unblocked						
vC, conflicting volume			208			869 208
vC1, stage 1 conf vol						
vC2, stage 2 conf vol						
vCu, unblocked vol			208			869 208
tC, single (s)			4.1			6.4 6.2
tC, 2 stage (s)						
tF (s)			2.2			3.5 3.3
p0 queue free %			100			70 83
cM capacity (veh/h)			1351			320 827
Direction, Lane #	EB 1	WB 1	NB 1	NB 2		
Volume Total	208	661	95	141		
Volume Left	0	0	95	0		
Volume Right	0	0	0	141		
cSH	1700	1700	320	827		
Volume to Capacity	0.12	0.39	0.30	0.17		
Queue Length 95th (ft)	0	0	30	15		
Control Delay (s)	0.0	0.0	20.9	10.2		
Lane LOS			C	B		
Approach Delay (s)	0.0	0.0	14.6			
Approach LOS			B			
Intersection Summary						
Average Delay			3.1			
Intersection Capacity Utilization			43.0%	ICU Level of Service		A
Analysis Period (min)			15			

3: Montevallo Road & Brookhill

03/30/2022



Movement	EBL	EBT	WBT	WBR	SBL	SBR
Lane Configurations						
Traffic Volume (veh/h)	2	302	588	3	5	5
Future Volume (Veh/h)	2	302	588	3	5	5
Sign Control		Free	Free		Stop	
Grade		0%	0%		0%	
Peak Hour Factor	0.91	0.91	0.86	0.86	0.50	0.50
Hourly flow rate (vph)	2	332	684	3	10	10
Pedestrians						
Lane Width (ft)						
Walking Speed (ft/s)						
Percent Blockage						
Right turn flare (veh)						
Median type		None	None			
Median storage (veh)						
Upstream signal (ft)			801			
pX, platoon unblocked	0.92				0.92	0.92
vC, conflicting volume	687				1022	686
vC1, stage 1 conf vol						
vC2, stage 2 conf vol						
vCu, unblocked vol	613				978	611
tC, single (s)	4.1				6.4	6.2
tC, 2 stage (s)						
tF (s)	2.2				3.5	3.3
p0 queue free %	100				96	98
cM capacity (veh/h)	877				252	449

Direction, Lane #	EB 1	EB 2	WB 1	SB 1
Volume Total	2	332	687	20
Volume Left	2	0	0	10
Volume Right	0	0	3	10
cSH	877	1700	1700	323
Volume to Capacity	0.00	0.20	0.40	0.06
Queue Length 95th (ft)	0	0	0	5
Control Delay (s)	9.1	0.0	0.0	16.9
Lane LOS	A			C
Approach Delay (s)	0.1		0.0	16.9
Approach LOS				C

Intersection Summary			
Average Delay		0.3	
Intersection Capacity Utilization		41.1%	ICU Level of Service
Analysis Period (min)		15	A

HCM Signalized Intersection Capacity Analysis

4: Cahaba Road & Montevallo Road



Movement	EBL	EBT	EBR	WBL	WBT	WBR	NBL	NBT	NBR	SBL	SBT	SBR
Lane Configurations												
Traffic Volume (vph)	73	169	35	48	291	1	58	158	48	10	227	217
Future Volume (vph)	73	169	35	48	291	1	58	158	48	10	227	217
Ideal Flow (vphpl)	1900	1900	1900	1900	1900	1900	1900	1900	1900	1900	1900	1900
Total Lost time (s)	4.5	4.5		4.5	4.5		4.5	4.5		4.5	4.5	
Lane Util. Factor	1.00	1.00		1.00	1.00		1.00	1.00		1.00	1.00	
Frt	1.00	0.97		1.00	1.00		1.00	0.96		1.00	0.93	
Flt Protected	0.95	1.00		0.95	1.00		0.95	1.00		0.95	1.00	
Satd. Flow (prot)	1736	1780		1736	1826		1736	1763		1736	1693	
Flt Permitted	0.49	1.00		0.61	1.00		0.38	1.00		0.61	1.00	
Satd. Flow (perm)	896	1780		1108	1826		690	1763		1119	1693	
Peak-hour factor, PHF	0.83	0.83	0.83	0.86	0.86	0.86	0.88	0.88	0.88	0.94	0.94	0.94
Adj. Flow (vph)	88	204	42	56	338	1	66	180	55	11	241	231
RTOR Reduction (vph)	0	10	0	0	0	0	0	17	0	0	54	0
Lane Group Flow (vph)	88	236	0	56	339	0	66	218	0	11	418	0
Turn Type	Perm	NA		Perm	NA		Perm	NA		Perm	NA	
Protected Phases		4			4			2			2	
Permitted Phases	4			4			2			2		
Actuated Green, G (s)	15.8	15.8		15.8	15.8		18.5	18.5		18.5	18.5	
Effective Green, g (s)	15.8	15.8		15.8	15.8		18.5	18.5		18.5	18.5	
Actuated g/C Ratio	0.36	0.36		0.36	0.36		0.43	0.43		0.43	0.43	
Clearance Time (s)	4.5	4.5		4.5	4.5		4.5	4.5		4.5	4.5	
Vehicle Extension (s)	3.0	3.0		3.0	3.0		3.0	3.0		3.0	3.0	
Lane Grp Cap (vph)	326	649		404	666		294	753		478	723	
v/s Ratio Prot		0.13			c0.19			0.12			c0.25	
v/s Ratio Perm	0.10			0.05			0.10			0.01		
v/c Ratio	0.27	0.36		0.14	0.51		0.22	0.29		0.02	0.58	
Uniform Delay, d1	9.7	10.1		9.2	10.7		7.9	8.1		7.2	9.4	
Progression Factor	1.00	1.00		1.00	1.00		1.00	1.00		1.00	1.00	
Incremental Delay, d2	0.4	0.3		0.2	0.6		0.4	0.2		0.0	1.1	
Delay (s)	10.1	10.4		9.4	11.3		8.2	8.3		7.2	10.6	
Level of Service	B	B		A	B		A	A		A	B	
Approach Delay (s)		10.3			11.1			8.3			10.5	
Approach LOS		B			B			A			B	

Intersection Summary

HCM 2000 Control Delay	10.2	HCM 2000 Level of Service	B
HCM 2000 Volume to Capacity ratio	0.55		
Actuated Cycle Length (s)	43.3	Sum of lost time (s)	9.0
Intersection Capacity Utilization	63.9%	ICU Level of Service	B
Analysis Period (min)	15		

c Critical Lane Group

HCM Unsignalized Intersection Capacity Analysis

5: Cahaba Road & Chester Road



Movement	EBL	EBR	NBL	NBT	SBT	SBR
Lane Configurations						
Traffic Volume (veh/h)	7	4	2	264	322	2
Future Volume (Veh/h)	7	4	2	264	322	2
Sign Control	Stop			Free	Free	
Grade	0%			0%	0%	
Peak Hour Factor	0.46	0.46	0.81	0.81	0.98	0.98
Hourly flow rate (vph)	15	9	2	326	329	2
Pedestrians						
Lane Width (ft)						
Walking Speed (ft/s)						
Percent Blockage						
Right turn flare (veh)						
Median type				None	None	
Median storage (veh)						
Upstream signal (ft)					605	
pX, platoon unblocked						
vC, conflicting volume	660	330	331			
vC1, stage 1 conf vol						
vC2, stage 2 conf vol						
vCu, unblocked vol	660	330	331			
tC, single (s)	6.4	6.2	4.1			
tC, 2 stage (s)						
tF (s)	3.5	3.3	2.2			
p0 queue free %	96	99	100			
cM capacity (veh/h)	424	707	1217			
Direction, Lane #	EB 1	NB 1	NB 2	SB 1		
Volume Total	24	2	326	331		
Volume Left	15	2	0	0		
Volume Right	9	0	0	2		
cSH	499	1217	1700	1700		
Volume to Capacity	0.05	0.00	0.19	0.19		
Queue Length 95th (ft)	4	0	0	0		
Control Delay (s)	12.6	8.0	0.0	0.0		
Lane LOS	B	A				
Approach Delay (s)	12.6	0.0		0.0		
Approach LOS	B					
Intersection Summary						
Average Delay			0.5			
Intersection Capacity Utilization			27.1%		ICU Level of Service	A
Analysis Period (min)			15			

HCM Unsignalized Intersection Capacity Analysis

1: US-280 Entrance Ramp & Hollywood Blvd



Movement	EBT	EBR	WBL	WBT	NBL	NBR
Lane Configurations						
Traffic Volume (veh/h)	280	178	378	315	0	0
Future Volume (Veh/h)	280	178	378	315	0	0
Sign Control	Free			Free	Stop	
Grade	0%			0%	0%	
Peak Hour Factor	0.95	0.95	0.92	0.92	0.92	0.92
Hourly flow rate (vph)	295	187	411	342	0	0
Pedestrians						
Lane Width (ft)						
Walking Speed (ft/s)						
Percent Blockage						
Right turn flare (veh)						
Median type	None			None		
Median storage (veh)						
Upstream signal (ft)						
pX, platoon unblocked						
vC, conflicting volume			295	1552	388	
vC1, stage 1 conf vol						
vC2, stage 2 conf vol						
vCu, unblocked vol			295	1552	388	
tC, single (s)			4.1	6.4	6.2	
tC, 2 stage (s)						
tF (s)			2.2	3.5	3.3	
p0 queue free %			67	100	100	
cM capacity (veh/h)			1255	83	655	
Direction, Lane #	EB 1	WB 1				
Volume Total	482	753				
Volume Left	0	411				
Volume Right	187	0				
cSH	1700	1255				
Volume to Capacity	0.28	0.33				
Queue Length 95th (ft)	0	36				
Control Delay (s)	0.0	6.8				
Lane LOS			A			
Approach Delay (s)	0.0	6.8				
Approach LOS						
Intersection Summary						
Average Delay			4.1			
Intersection Capacity Utilization			69.8%	ICU Level of Service		C
Analysis Period (min)			15			

HCM Unsignalized Intersection Capacity Analysis

2: US-280 Exit Ramp & Hollywood Blvd/Montevallo Road

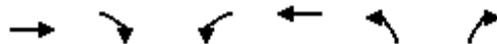

Movement	EBT	EBR	WBL	WBT	NBL	NBR
Lane Configurations	↑			↑	↘	↗
Traffic Volume (veh/h)	277	0	0	543	112	154
Future Volume (Veh/h)	277	0	0	543	112	154
Sign Control	Free			Free	Stop	
Grade	0%			0%	0%	
Peak Hour Factor	0.91	0.91	0.92	0.92	0.90	0.90
Hourly flow rate (vph)	304	0	0	590	124	171
Pedestrians						
Lane Width (ft)						
Walking Speed (ft/s)						
Percent Blockage						
Right turn flare (veh)						
Median type	None		None			
Median storage (veh)						
Upstream signal (ft)						
pX, platoon unblocked						
vC, conflicting volume			304		894	304
vC1, stage 1 conf vol						
vC2, stage 2 conf vol						
vCu, unblocked vol			304		894	304
tC, single (s)			4.1		6.4	6.2
tC, 2 stage (s)						
tF (s)			2.2		3.5	3.3
p0 queue free %			100		60	77
cM capacity (veh/h)			1246		309	731
Direction, Lane #	EB 1	WB 1	NB 1	NB 2		
Volume Total	304	590	124	171		
Volume Left	0	0	124	0		
Volume Right	0	0	0	171		
cSH	1700	1700	309	731		
Volume to Capacity	0.18	0.35	0.40	0.23		
Queue Length 95th (ft)	0	0	47	23		
Control Delay (s)	0.0	0.0	24.2	11.4		
Lane LOS			C	B		
Approach Delay (s)	0.0	0.0	16.8			
Approach LOS			C			
Intersection Summary						
Average Delay			4.2			
Intersection Capacity Utilization			41.5%	ICU Level of Service		A
Analysis Period (min)			15			

HCM Unsignalized Intersection Capacity Analysis

3: Montevallo Road & Brookhill



Movement	EBL	EBT	WBT	WBR	SBL	SBR
Lane Configurations	↶	↗	↶		↘	↘
Traffic Volume (veh/h)	8	418	568	5	7	13
Future Volume (Veh/h)	8	418	568	5	7	13
Sign Control		Free	Free		Stop	
Grade		0%	0%		0%	
Peak Hour Factor	0.87	0.87	0.89	0.89	0.63	0.63
Hourly flow rate (vph)	9	480	638	6	11	21
Pedestrians						
Lane Width (ft)						
Walking Speed (ft/s)						
Percent Blockage						
Right turn flare (veh)						
Median type		None	None			
Median storage (veh)						
Upstream signal (ft)			801			
pX, platoon unblocked	0.97				0.97	0.97
vC, conflicting volume	644				1139	641
vC1, stage 1 conf vol						
vC2, stage 2 conf vol						
vCu, unblocked vol	620				1129	617
tC, single (s)	4.1				6.4	6.2
tC, 2 stage (s)						
tF (s)	2.2				3.5	3.3
p0 queue free %	99				95	96
cM capacity (veh/h)	925				215	473
Direction, Lane #	EB 1	EB 2	WB 1	SB 1		
Volume Total	9	480	644	32		
Volume Left	9	0	0	11		
Volume Right	0	0	6	21		
cSH	925	1700	1700	335		
Volume to Capacity	0.01	0.28	0.38	0.10		
Queue Length 95th (ft)	1	0	0	8		
Control Delay (s)	8.9	0.0	0.0	16.9		
Lane LOS	A			C		
Approach Delay (s)	0.2		0.0	16.9		
Approach LOS				C		
Intersection Summary						
Average Delay			0.5			
Intersection Capacity Utilization			40.2%		ICU Level of Service	A
Analysis Period (min)			15			

HCM Signalized Intersection Capacity Analysis

4: Cahaba Road & Montevallo Road



Movement	EBL	EBT	EBR	WBL	WBT	WBR	NBL	NBT	NBR	SBL	SBT	SBR
Lane Configurations												
Traffic Volume (vph)	101	315	40	48	232	1	59	234	111	23	220	217
Future Volume (vph)	101	315	40	48	232	1	59	234	111	23	220	217
Ideal Flow (vphpl)	1900	1900	1900	1900	1900	1900	1900	1900	1900	1900	1900	1900
Total Lost time (s)	4.5	4.5		4.5	4.5		4.5	4.5		4.5	4.5	
Lane Util. Factor	1.00	1.00		1.00	1.00		1.00	1.00		1.00	1.00	
Frt	1.00	0.98		1.00	1.00		1.00	0.95		1.00	0.93	
Flt Protected	0.95	1.00		0.95	1.00		0.95	1.00		0.95	1.00	
Satd. Flow (prot)	1736	1796		1736	1826		1736	1739		1736	1691	
Flt Permitted	0.57	1.00		0.43	1.00		0.36	1.00		0.47	1.00	
Satd. Flow (perm)	1038	1796		777	1826		655	1739		852	1691	
Peak-hour factor, PHF	0.93	0.93	0.93	0.87	0.87	0.87	0.90	0.90	0.90	0.89	0.89	0.89
Adj. Flow (vph)	109	339	43	55	267	1	66	260	123	26	247	244
RTOR Reduction (vph)	0	6	0	0	0	0	0	25	0	0	53	0
Lane Group Flow (vph)	109	376	0	55	268	0	66	358	0	26	438	0
Turn Type	Perm	NA		Perm	NA		Perm	NA		Perm	NA	
Protected Phases		4			4			2			2	
Permitted Phases	4			4			2			2		
Actuated Green, G (s)	17.6	17.6		17.6	17.6		21.1	21.1		21.1	21.1	
Effective Green, g (s)	17.6	17.6		17.6	17.6		21.1	21.1		21.1	21.1	
Actuated g/C Ratio	0.37	0.37		0.37	0.37		0.44	0.44		0.44	0.44	
Clearance Time (s)	4.5	4.5		4.5	4.5		4.5	4.5		4.5	4.5	
Vehicle Extension (s)	3.0	3.0		3.0	3.0		3.0	3.0		3.0	3.0	
Lane Grp Cap (vph)	382	662		286	673		289	769		376	748	
v/s Ratio Prot		c0.21			0.15			0.21			c0.26	
v/s Ratio Perm	0.10			0.07			0.10			0.03		
v/c Ratio	0.29	0.57		0.19	0.40		0.23	0.47		0.07	0.59	
Uniform Delay, d1	10.6	12.0		10.2	11.1		8.3	9.3		7.7	10.0	
Progression Factor	1.00	1.00		1.00	1.00		1.00	1.00		1.00	1.00	
Incremental Delay, d2	0.4	1.1		0.3	0.4		0.4	0.4		0.1	1.2	
Delay (s)	11.0	13.1		10.6	11.5		8.7	9.8		7.7	11.2	
Level of Service	B	B		B	B		A	A		A	B	
Approach Delay (s)		12.7			11.4			9.6			11.0	
Approach LOS		B			B			A			B	

Intersection Summary

HCM 2000 Control Delay	11.2	HCM 2000 Level of Service	B
HCM 2000 Volume to Capacity ratio	0.58		
Actuated Cycle Length (s)	47.7	Sum of lost time (s)	9.0
Intersection Capacity Utilization	67.2%	ICU Level of Service	C
Analysis Period (min)	15		

c Critical Lane Group

HCM Unsignalized Intersection Capacity Analysis

5: Cahaba Road & Chester Road



Movement	EBL	EBR	NBL	NBT	SBT	SBR
Lane Configurations						
Traffic Volume (veh/h)	3	3	5	358	329	3
Future Volume (Veh/h)	3	3	5	358	329	3
Sign Control	Stop			Free	Free	
Grade	0%			0%	0%	
Peak Hour Factor	0.75	0.75	0.87	0.87	0.89	0.89
Hourly flow rate (vph)	4	4	6	411	370	3
Pedestrians						
Lane Width (ft)						
Walking Speed (ft/s)						
Percent Blockage						
Right turn flare (veh)						
Median type				None	None	
Median storage (veh)						
Upstream signal (ft)					605	
pX, platoon unblocked						
vC, conflicting volume	794	372	373			
vC1, stage 1 conf vol						
vC2, stage 2 conf vol						
vCu, unblocked vol	794	372	373			
tC, single (s)	6.4	6.2	4.1			
tC, 2 stage (s)						
tF (s)	3.5	3.3	2.2			
p0 queue free %	99	99	99			
cM capacity (veh/h)	352	670	1175			
Direction, Lane #	EB 1	NB 1	NB 2	SB 1		
Volume Total	8	6	411	373		
Volume Left	4	6	0	0		
Volume Right	4	0	0	3		
cSH	462	1175	1700	1700		
Volume to Capacity	0.02	0.01	0.24	0.22		
Queue Length 95th (ft)	1	0	0	0		
Control Delay (s)	12.9	8.1	0.0	0.0		
Lane LOS	B	A				
Approach Delay (s)	12.9	0.1		0.0		
Approach LOS	B					
Intersection Summary						
Average Delay			0.2			
Intersection Capacity Utilization			28.8%		ICU Level of Service	A
Analysis Period (min)			15			

Appendix E

Background 2025 Intersection Capacity Analysis Worksheets

HCM Unsignalized Intersection Capacity Analysis

1: US-280 Entrance Ramp & Hollywood Blvd

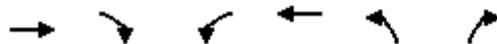

Movement	EBT	EBR	WBL	WBT	NBL	NBR
Lane Configurations	↻		↻	↻		
Traffic Volume (veh/h)	190	156	448	217	0	0
Future Volume (Veh/h)	190	156	448	217	0	0
Sign Control	Free			Free	Stop	
Grade	0%			0%	0%	
Peak Hour Factor	0.82	0.82	0.91	0.91	0.92	0.92
Hourly flow rate (vph)	232	190	492	238	0	0
Pedestrians						
Lane Width (ft)						
Walking Speed (ft/s)						
Percent Blockage						
Right turn flare (veh)						
Median type	None		None			
Median storage (veh)						
Upstream signal (ft)	260					
pX, platoon unblocked						
vC, conflicting volume			232		1549	327
vC1, stage 1 conf vol						
vC2, stage 2 conf vol						
vCu, unblocked vol			232		1549	327
tC, single (s)			4.1		6.4	6.2
tC, 2 stage (s)						
tF (s)			2.2		3.5	3.3
p0 queue free %			63		100	100
cM capacity (veh/h)			1324		78	710
Direction, Lane #	EB 1	WB 1	WB 2			
Volume Total	422	492	238			
Volume Left	0	492	0			
Volume Right	190	0	0			
cSH	1700	1324	1700			
Volume to Capacity	0.25	0.37	0.14			
Queue Length 95th (ft)	0	44	0			
Control Delay (s)	0.0	9.3	0.0			
Lane LOS	A					
Approach Delay (s)	0.0	6.3				
Approach LOS						
Intersection Summary						
Average Delay			4.0			
Intersection Capacity Utilization			51.0%	ICU Level of Service	A	
Analysis Period (min)	15					

HCM Signalized Intersection Capacity Analysis

2: US-280 Exit Ramp & Hollywood Blvd/Montevallo Road



Movement	EBT	EBR	WBL	WBT	NBL	NBR
Lane Configurations	↑			↑	↙	↘
Traffic Volume (vph)	186	0	0	604	91	136
Future Volume (vph)	186	0	0	604	91	136
Ideal Flow (vphpl)	1900	1900	1900	1900	1900	1900
Total Lost time (s)	4.5			4.5	4.5	4.5
Lane Util. Factor	1.00			1.00	1.00	1.00
Frt	1.00			1.00	1.00	0.85
Flt Protected	1.00			1.00	0.95	1.00
Satd. Flow (prot)	1827			1827	1736	1553
Flt Permitted	1.00			1.00	0.95	1.00
Satd. Flow (perm)	1827			1827	1736	1553
Peak-hour factor, PHF	0.88	0.88	0.90	0.90	0.95	0.95
Adj. Flow (vph)	211	0	0	671	96	143
RTOR Reduction (vph)	0	0	0	0	0	121
Lane Group Flow (vph)	211	0	0	671	96	22
Turn Type	NA			NA	Prot	Perm
Protected Phases	2			2	4	
Permitted Phases						4
Actuated Green, G (s)	25.4			25.4	6.4	6.4
Effective Green, g (s)	25.4			25.4	6.4	6.4
Actuated g/C Ratio	0.62			0.62	0.16	0.16
Clearance Time (s)	4.5			4.5	4.5	4.5
Vehicle Extension (s)	3.0			3.0	3.0	3.0
Lane Grp Cap (vph)	1137			1137	272	243
v/s Ratio Prot	0.12			c0.37	c0.06	
v/s Ratio Perm						0.01
v/c Ratio	0.19			0.59	0.35	0.09
Uniform Delay, d1	3.3			4.6	15.4	14.7
Progression Factor	1.00			1.00	1.00	1.00
Incremental Delay, d2	0.1			0.8	0.8	0.2
Delay (s)	3.4			5.4	16.1	14.9
Level of Service	A			A	B	B
Approach Delay (s)	3.4			5.4	15.4	
Approach LOS	A			A	B	

Intersection Summary

HCM 2000 Control Delay	7.2	HCM 2000 Level of Service	A
HCM 2000 Volume to Capacity ratio	0.54		
Actuated Cycle Length (s)	40.8	Sum of lost time (s)	9.0
Intersection Capacity Utilization	51.0%	ICU Level of Service	A
Analysis Period (min)	15		

c Critical Lane Group

3: Montevallo Road & Brookhill

03/31/2022

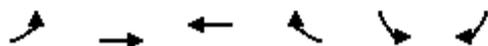

Movement	EBL	EBT	WBT	WBR	SBL	SBR
Lane Configurations						
Traffic Volume (veh/h)	2	307	597	3	5	5
Future Volume (Veh/h)	2	307	597	3	5	5
Sign Control		Free	Free		Stop	
Grade		0%	0%		0%	
Peak Hour Factor	0.91	0.91	0.86	0.86	0.50	0.50
Hourly flow rate (vph)	2	337	694	3	10	10
Pedestrians						
Lane Width (ft)						
Walking Speed (ft/s)						
Percent Blockage						
Right turn flare (veh)						
Median type		None	None			
Median storage (veh)						
Upstream signal (ft)		1280	801			
pX, platoon unblocked	0.93				0.93	0.93
vC, conflicting volume	697				1036	696
vC1, stage 1 conf vol						
vC2, stage 2 conf vol						
vCu, unblocked vol	634				1000	633
tC, single (s)	4.1				6.4	6.2
tC, 2 stage (s)						
tF (s)	2.2				3.5	3.3
p0 queue free %	100				96	98
cM capacity (veh/h)	871				247	442

Direction, Lane #	EB 1	EB 2	WB 1	SB 1
Volume Total	2	337	697	20
Volume Left	2	0	0	10
Volume Right	0	0	3	10
cSH	871	1700	1700	317
Volume to Capacity	0.00	0.20	0.41	0.06
Queue Length 95th (ft)	0	0	0	5
Control Delay (s)	9.1	0.0	0.0	17.1
Lane LOS	A			C
Approach Delay (s)	0.1		0.0	17.1
Approach LOS				C

Intersection Summary			
Average Delay		0.3	
Intersection Capacity Utilization		41.6%	ICU Level of Service A
Analysis Period (min)		15	

HCM Signalized Intersection Capacity Analysis

4: Cahaba Road & Montevallo Road



Movement	EBL	EBT	EBR	WBL	WBT	WBR	NBL	NBT	NBR	SBL	SBT	SBR
Lane Configurations												
Traffic Volume (vph)	74	172	36	49	285	1	59	160	49	10	230	220
Future Volume (vph)	74	172	36	49	285	1	59	160	49	10	230	220
Ideal Flow (vphpl)	1900	1900	1900	1900	1900	1900	1900	1900	1900	1900	1900	1900
Total Lost time (s)	4.5	4.5		4.5	4.5		4.5	4.5		4.5	4.5	
Lane Util. Factor	1.00	1.00		1.00	1.00		1.00	1.00		1.00	1.00	
Frt	1.00	0.97		1.00	1.00		1.00	0.96		1.00	0.93	
Flt Protected	0.95	1.00		0.95	1.00		0.95	1.00		0.95	1.00	
Satd. Flow (prot)	1736	1780		1736	1826		1736	1762		1736	1693	
Flt Permitted	0.50	1.00		0.60	1.00		0.37	1.00		0.61	1.00	
Satd. Flow (perm)	909	1780		1103	1826		681	1762		1116	1693	
Peak-hour factor, PHF	0.83	0.83	0.83	0.86	0.86	0.86	0.88	0.88	0.88	0.94	0.94	0.94
Adj. Flow (vph)	89	207	43	57	331	1	67	182	56	11	245	234
RTOR Reduction (vph)	0	10	0	0	0	0	0	17	0	0	53	0
Lane Group Flow (vph)	89	240	0	57	332	0	67	221	0	11	426	0
Turn Type	Perm	NA		Perm	NA		Perm	NA		Perm	NA	
Protected Phases		4			4			2			2	
Permitted Phases	4			4			2			2		
Actuated Green, G (s)	15.7	15.7		15.7	15.7		18.7	18.7		18.7	18.7	
Effective Green, g (s)	15.7	15.7		15.7	15.7		18.7	18.7		18.7	18.7	
Actuated g/C Ratio	0.36	0.36		0.36	0.36		0.43	0.43		0.43	0.43	
Clearance Time (s)	4.5	4.5		4.5	4.5		4.5	4.5		4.5	4.5	
Vehicle Extension (s)	3.0	3.0		3.0	3.0		3.0	3.0		3.0	3.0	
Lane Grp Cap (vph)	328	643		399	660		293	759		480	729	
v/s Ratio Prot		0.13			c0.18			0.13			c0.25	
v/s Ratio Perm	0.10			0.05			0.10			0.01		
v/c Ratio	0.27	0.37		0.14	0.50		0.23	0.29		0.02	0.58	
Uniform Delay, d1	9.8	10.2		9.3	10.8		7.8	8.0		7.1	9.4	
Progression Factor	1.00	1.00		1.00	1.00		1.00	1.00		1.00	1.00	
Incremental Delay, d2	0.4	0.4		0.2	0.6		0.4	0.2		0.0	1.2	
Delay (s)	10.3	10.6		9.5	11.4		8.2	8.3		7.1	10.6	
Level of Service	B	B		A	B		A	A		A	B	
Approach Delay (s)		10.5			11.1			8.2			10.5	
Approach LOS		B			B			A			B	

Intersection Summary

HCM 2000 Control Delay	10.2	HCM 2000 Level of Service	B
HCM 2000 Volume to Capacity ratio	0.55		
Actuated Cycle Length (s)	43.4	Sum of lost time (s)	9.0
Intersection Capacity Utilization	64.0%	ICU Level of Service	B
Analysis Period (min)	15		

c Critical Lane Group

HCM Unsignalized Intersection Capacity Analysis

5: Cahaba Road & Chester Road



Movement	EBL	EBR	NBL	NBT	SBT	SBR
Lane Configurations						
Traffic Volume (veh/h)	7	4	2	268	327	2
Future Volume (Veh/h)	7	4	2	268	327	2
Sign Control	Stop			Free	Free	
Grade	0%			0%	0%	
Peak Hour Factor	0.46	0.46	0.81	0.81	0.98	0.98
Hourly flow rate (vph)	15	9	2	331	334	2
Pedestrians						
Lane Width (ft)						
Walking Speed (ft/s)						
Percent Blockage						
Right turn flare (veh)						
Median type				None	None	
Median storage veh						
Upstream signal (ft)					605	
pX, platoon unblocked						
vC, conflicting volume	670	335	336			
vC1, stage 1 conf vol						
vC2, stage 2 conf vol						
vCu, unblocked vol	670	335	336			
tC, single (s)	6.4	6.2	4.1			
tC, 2 stage (s)						
tF (s)	3.5	3.3	2.2			
p0 queue free %	96	99	100			
cM capacity (veh/h)	418	702	1212			
Direction, Lane #	EB 1	NB 1	NB 2	SB 1		
Volume Total	24	2	331	336		
Volume Left	15	2	0	0		
Volume Right	9	0	0	2		
cSH	493	1212	1700	1700		
Volume to Capacity	0.05	0.00	0.19	0.20		
Queue Length 95th (ft)	4	0	0	0		
Control Delay (s)	12.7	8.0	0.0	0.0		
Lane LOS	B	A				
Approach Delay (s)	12.7	0.0		0.0		
Approach LOS	B					
Intersection Summary						
Average Delay			0.5			
Intersection Capacity Utilization			27.3%	ICU Level of Service	A	
Analysis Period (min)			15			

HCM Unsignalized Intersection Capacity Analysis

1: US-280 Entrance Ramp & Hollywood Blvd

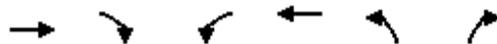

Movement	EBT	EBR	WBL	WBT	NBL	NBR
Lane Configurations	↻		↻	↻		
Traffic Volume (veh/h)	284	181	384	320	0	0
Future Volume (Veh/h)	284	181	384	320	0	0
Sign Control	Free			Free	Stop	
Grade	0%			0%	0%	
Peak Hour Factor	0.95	0.95	0.92	0.92	0.92	0.92
Hourly flow rate (vph)	299	191	417	348	0	0
Pedestrians						
Lane Width (ft)						
Walking Speed (ft/s)						
Percent Blockage						
Right turn flare (veh)						
Median type	None		None			
Median storage (veh)						
Upstream signal (ft)	260					
pX, platoon unblocked						
vC, conflicting volume			299		1576	394
vC1, stage 1 conf vol						
vC2, stage 2 conf vol						
vCu, unblocked vol			299		1576	394
tC, single (s)			4.1		6.4	6.2
tC, 2 stage (s)						
tF (s)			2.2		3.5	3.3
p0 queue free %			67		100	100
cM capacity (veh/h)			1251		80	650
Direction, Lane #	EB 1	WB 1	WB 2			
Volume Total	490	417	348			
Volume Left	0	417	0			
Volume Right	191	0	0			
cSH	1700	1251	1700			
Volume to Capacity	0.29	0.33	0.20			
Queue Length 95th (ft)	0	37	0			
Control Delay (s)	0.0	9.3	0.0			
Lane LOS	A					
Approach Delay (s)	0.0	5.1				
Approach LOS						
Intersection Summary						
Average Delay			3.1			
Intersection Capacity Utilization			53.9%	ICU Level of Service	A	
Analysis Period (min)	15					

HCM Signalized Intersection Capacity Analysis

2: US-280 Exit Ramp & Hollywood Blvd/Montevallo Road



Movement	EBT	EBR	WBL	WBT	NBL	NBR
Lane Configurations	↑			↑	↘	↗
Traffic Volume (vph)	281	0	0	551	114	156
Future Volume (vph)	281	0	0	551	114	156
Ideal Flow (vphpl)	1900	1900	1900	1900	1900	1900
Total Lost time (s)	4.5			4.5	4.5	4.5
Lane Util. Factor	1.00			1.00	1.00	1.00
Frt	1.00			1.00	1.00	0.85
Flt Protected	1.00			1.00	0.95	1.00
Satd. Flow (prot)	1827			1827	1736	1553
Flt Permitted	1.00			1.00	0.95	1.00
Satd. Flow (perm)	1827			1827	1736	1553
Peak-hour factor, PHF	0.91	0.91	0.92	0.92	0.90	0.90
Adj. Flow (vph)	309	0	0	599	127	173
RTOR Reduction (vph)	0	0	0	0	0	142
Lane Group Flow (vph)	309	0	0	599	127	31
Turn Type	NA			NA	Prot	Perm
Protected Phases	2			2	4	
Permitted Phases						4
Actuated Green, G (s)	23.7			23.7	7.0	7.0
Effective Green, g (s)	23.7			23.7	7.0	7.0
Actuated g/C Ratio	0.60			0.60	0.18	0.18
Clearance Time (s)	4.5			4.5	4.5	4.5
Vehicle Extension (s)	3.0			3.0	3.0	3.0
Lane Grp Cap (vph)	1090			1090	306	273
v/s Ratio Prot	0.17			c0.33	c0.07	
v/s Ratio Perm						0.02
v/c Ratio	0.28			0.55	0.42	0.11
Uniform Delay, d1	3.9			4.8	14.5	13.7
Progression Factor	1.00			1.00	1.00	1.00
Incremental Delay, d2	0.1			0.6	0.9	0.2
Delay (s)	4.0			5.4	15.4	13.9
Level of Service	A			A	B	B
Approach Delay (s)	4.0			5.4	14.6	
Approach LOS	A			A	B	

Intersection Summary

HCM 2000 Control Delay	7.3	HCM 2000 Level of Service	A
HCM 2000 Volume to Capacity ratio	0.52		
Actuated Cycle Length (s)	39.7	Sum of lost time (s)	9.0
Intersection Capacity Utilization	53.9%	ICU Level of Service	A
Analysis Period (min)	15		

c Critical Lane Group

3: Montevallo Road & Brookhill

03/31/2022



Movement	EBL	EBT	WBT	WBR	SBL	SBR
Lane Configurations	↖	↑	↗		↘	↘
Traffic Volume (veh/h)	8	424	577	5	7	13
Future Volume (Veh/h)	8	424	577	5	7	13
Sign Control		Free	Free		Stop	
Grade		0%	0%		0%	
Peak Hour Factor	0.87	0.87	0.89	0.89	0.63	0.63
Hourly flow rate (vph)	9	487	648	6	11	21
Pedestrians						
Lane Width (ft)						
Walking Speed (ft/s)						
Percent Blockage						
Right turn flare (veh)						
Median type		None	None			
Median storage (veh)						
Upstream signal (ft)		1280	801			
pX, platoon unblocked	0.97				0.97	0.97
vC, conflicting volume	654				1156	651
vC1, stage 1 conf vol						
vC2, stage 2 conf vol						
vCu, unblocked vol	625				1144	621
tC, single (s)	4.1				6.4	6.2
tC, 2 stage (s)						
tF (s)	2.2				3.5	3.3
p0 queue free %	99				95	96
cM capacity (veh/h)	915				210	467

Direction, Lane #	EB 1	EB 2	WB 1	SB 1
Volume Total	9	487	654	32
Volume Left	9	0	0	11
Volume Right	0	0	6	21
cSH	915	1700	1700	328
Volume to Capacity	0.01	0.29	0.38	0.10
Queue Length 95th (ft)	1	0	0	8
Control Delay (s)	9.0	0.0	0.0	17.1
Lane LOS	A			C
Approach Delay (s)	0.2		0.0	17.1
Approach LOS				C

Intersection Summary			
Average Delay		0.5	
Intersection Capacity Utilization		40.7%	ICU Level of Service A
Analysis Period (min)		15	

HCM Signalized Intersection Capacity Analysis

4: Cahaba Road & Montevallo Road



Movement	EBL	EBT	EBR	WBL	WBT	WBR	NBL	NBT	NBR	SBL	SBT	SBR
Lane Configurations	↰	→	↱	↰	→	↱	↰	→	↱	↰	→	↱
Traffic Volume (vph)	103	320	41	49	235	1	60	238	113	23	223	220
Future Volume (vph)	103	320	41	49	235	1	60	238	113	23	223	220
Ideal Flow (vphpl)	1900	1900	1900	1900	1900	1900	1900	1900	1900	1900	1900	1900
Total Lost time (s)	4.5	4.5		4.5	4.5		4.5	4.5		4.5	4.5	
Lane Util. Factor	1.00	1.00		1.00	1.00		1.00	1.00		1.00	1.00	
Frt	1.00	0.98		1.00	1.00		1.00	0.95		1.00	0.93	
Flt Protected	0.95	1.00		0.95	1.00		0.95	1.00		0.95	1.00	
Satd. Flow (prot)	1736	1796		1736	1826		1736	1738		1736	1691	
Flt Permitted	0.56	1.00		0.41	1.00		0.35	1.00		0.46	1.00	
Satd. Flow (perm)	1025	1796		757	1826		645	1738		840	1691	
Peak-hour factor, PHF	0.93	0.93	0.93	0.87	0.87	0.87	0.90	0.90	0.90	0.89	0.89	0.89
Adj. Flow (vph)	111	344	44	56	270	1	67	264	126	26	251	247
RTOR Reduction (vph)	0	6	0	0	0	0	0	25	0	0	52	0
Lane Group Flow (vph)	111	382	0	56	271	0	67	365	0	26	446	0
Turn Type	Perm	NA		Perm	NA		Perm	NA		Perm	NA	
Protected Phases		4			4			2			2	
Permitted Phases	4			4			2			2		
Actuated Green, G (s)	17.9	17.9		17.9	17.9		21.8	21.8		21.8	21.8	
Effective Green, g (s)	17.9	17.9		17.9	17.9		21.8	21.8		21.8	21.8	
Actuated g/C Ratio	0.37	0.37		0.37	0.37		0.45	0.45		0.45	0.45	
Clearance Time (s)	4.5	4.5		4.5	4.5		4.5	4.5		4.5	4.5	
Vehicle Extension (s)	3.0	3.0		3.0	3.0		3.0	3.0		3.0	3.0	
Lane Grp Cap (vph)	376	660		278	671		288	777		376	756	
v/s Ratio Prot		c0.21			0.15			0.21			c0.26	
v/s Ratio Perm	0.11			0.07			0.10			0.03		
v/c Ratio	0.30	0.58		0.20	0.40		0.23	0.47		0.07	0.59	
Uniform Delay, d1	10.9	12.4		10.5	11.4		8.3	9.4		7.7	10.1	
Progression Factor	1.00	1.00		1.00	1.00		1.00	1.00		1.00	1.00	
Incremental Delay, d2	0.4	1.2		0.4	0.4		0.4	0.4		0.1	1.2	
Delay (s)	11.4	13.6		10.9	11.8		8.7	9.9		7.7	11.3	
Level of Service	B	B		B	B		A	A		A	B	
Approach Delay (s)		13.1			11.7			9.7			11.2	
Approach LOS		B			B			A			B	

Intersection Summary

HCM 2000 Control Delay	11.4	HCM 2000 Level of Service	B
HCM 2000 Volume to Capacity ratio	0.58		
Actuated Cycle Length (s)	48.7	Sum of lost time (s)	9.0
Intersection Capacity Utilization	67.9%	ICU Level of Service	C
Analysis Period (min)	15		

c Critical Lane Group

HCM Unsignalized Intersection Capacity Analysis

5: Cahaba Road & Chester Road



Movement	EBL	EBR	NBL	NBT	SBT	SBR
Lane Configurations						
Traffic Volume (veh/h)	3	3	5	363	334	3
Future Volume (Veh/h)	3	3	5	363	334	3
Sign Control	Stop			Free	Free	
Grade	0%			0%	0%	
Peak Hour Factor	0.75	0.75	0.87	0.87	0.89	0.89
Hourly flow rate (vph)	4	4	6	417	375	3
Pedestrians						
Lane Width (ft)						
Walking Speed (ft/s)						
Percent Blockage						
Right turn flare (veh)						
Median type				None	None	
Median storage (veh)						
Upstream signal (ft)					605	
pX, platoon unblocked						
vC, conflicting volume	806	376	378			
vC1, stage 1 conf vol						
vC2, stage 2 conf vol						
vCu, unblocked vol	806	376	378			
tC, single (s)	6.4	6.2	4.1			
tC, 2 stage (s)						
tF (s)	3.5	3.3	2.2			
p0 queue free %	99	99	99			
cM capacity (veh/h)	347	666	1170			
Direction, Lane #	EB 1	NB 1	NB 2	SB 1		
Volume Total	8	6	417	378		
Volume Left	4	6	0	0		
Volume Right	4	0	0	3		
cSH	456	1170	1700	1700		
Volume to Capacity	0.02	0.01	0.25	0.22		
Queue Length 95th (ft)	1	0	0	0		
Control Delay (s)	13.0	8.1	0.0	0.0		
Lane LOS	B	A				
Approach Delay (s)	13.0	0.1		0.0		
Approach LOS	B					
Intersection Summary						
Average Delay			0.2			
Intersection Capacity Utilization			29.1%		ICU Level of Service	A
Analysis Period (min)			15			

Appendix F

**Future 2025 Intersection Capacity Analysis
Worksheets**

HCM Unsignalized Intersection Capacity Analysis

1: US-280 Entrance Ramp & Hollywood Blvd

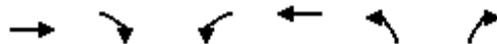

Movement	EBT	EBR	WBL	WBT	NBL	NBR
Lane Configurations	↻		↻	↻		
Traffic Volume (veh/h)	191	156	452	220	0	0
Future Volume (Veh/h)	191	156	452	220	0	0
Sign Control	Free			Free	Stop	
Grade	0%			0%	0%	
Peak Hour Factor	0.82	0.82	0.91	0.91	0.92	0.92
Hourly flow rate (vph)	233	190	497	242	0	0
Pedestrians						
Lane Width (ft)						
Walking Speed (ft/s)						
Percent Blockage						
Right turn flare (veh)						
Median type	None		None			
Median storage (veh)						
Upstream signal (ft)	260					
pX, platoon unblocked						
vC, conflicting volume			233		1564	328
vC1, stage 1 conf vol						
vC2, stage 2 conf vol						
vCu, unblocked vol			233		1564	328
tC, single (s)			4.1		6.4	6.2
tC, 2 stage (s)						
tF (s)			2.2		3.5	3.3
p0 queue free %			62		100	100
cM capacity (veh/h)			1323		76	709
Direction, Lane #	EB 1	WB 1	WB 2			
Volume Total	423	497	242			
Volume Left	0	497	0			
Volume Right	190	0	0			
cSH	1700	1323	1700			
Volume to Capacity	0.25	0.38	0.14			
Queue Length 95th (ft)	0	44	0			
Control Delay (s)	0.0	9.3	0.0			
Lane LOS	A					
Approach Delay (s)	0.0	6.3				
Approach LOS						
Intersection Summary						
Average Delay			4.0			
Intersection Capacity Utilization			51.3%	ICU Level of Service	A	
Analysis Period (min)			15			

HCM Signalized Intersection Capacity Analysis

2: US-280 Exit Ramp & Hollywood Blvd/Montevallo Road

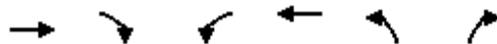

Movement	EBT	EBR	WBL	WBT	NBL	NBR
Lane Configurations	↑			↑	↘	↘
Traffic Volume (vph)	187	0	0	612	91	138
Future Volume (vph)	187	0	0	612	91	138
Ideal Flow (vphpl)	1900	1900	1900	1900	1900	1900
Total Lost time (s)	4.5			4.5	4.5	4.5
Lane Util. Factor	1.00			1.00	1.00	1.00
Frt	1.00			1.00	1.00	0.85
Flt Protected	1.00			1.00	0.95	1.00
Satd. Flow (prot)	1827			1827	1736	1553
Flt Permitted	1.00			1.00	0.95	1.00
Satd. Flow (perm)	1827			1827	1736	1553
Peak-hour factor, PHF	0.88	0.88	0.90	0.90	0.95	0.95
Adj. Flow (vph)	212	0	0	680	96	145
RTOR Reduction (vph)	0	0	0	0	0	122
Lane Group Flow (vph)	213	0	0	680	96	23
Turn Type	NA			NA	Prot	Perm
Protected Phases	2			2	4	
Permitted Phases						4
Actuated Green, G (s)	25.6			25.6	6.4	6.4
Effective Green, g (s)	25.6			25.6	6.4	6.4
Actuated g/C Ratio	0.62			0.62	0.16	0.16
Clearance Time (s)	4.5			4.5	4.5	4.5
Vehicle Extension (s)	3.0			3.0	3.0	3.0
Lane Grp Cap (vph)	1140			1140	270	242
v/s Ratio Prot	0.12			c0.37	c0.06	
v/s Ratio Perm						0.01
v/c Ratio	0.19			0.60	0.36	0.09
Uniform Delay, d1	3.3			4.6	15.5	14.8
Progression Factor	1.00			1.00	1.00	1.00
Incremental Delay, d2	0.1			0.8	0.8	0.2
Delay (s)	3.4			5.5	16.3	15.0
Level of Service	A			A	B	B
Approach Delay (s)	3.4			5.5	15.5	
Approach LOS	A			A	B	

Intersection Summary			
HCM 2000 Control Delay	7.2	HCM 2000 Level of Service	A
HCM 2000 Volume to Capacity ratio	0.55		
Actuated Cycle Length (s)	41.0	Sum of lost time (s)	9.0
Intersection Capacity Utilization	51.3%	ICU Level of Service	A
Analysis Period (min)	15		

c Critical Lane Group

HCM Unsignalized Intersection Capacity Analysis

3: Montevallo Road & Brookhill



Movement	EBL	EBT	WBT	WBR	SBL	SBR
Lane Configurations						
Traffic Volume (veh/h)	2	315	600	3	5	5
Future Volume (Veh/h)	2	315	600	3	5	5
Sign Control		Free	Free		Stop	
Grade		0%	0%		0%	
Peak Hour Factor	0.91	0.91	0.86	0.86	0.50	0.50
Hourly flow rate (vph)	2	346	698	3	10	10
Pedestrians						
Lane Width (ft)						
Walking Speed (ft/s)						
Percent Blockage						
Right turn flare (veh)						
Median type		None	None			
Median storage (veh)						
Upstream signal (ft)		1280	801			
pX, platoon unblocked	0.93				0.93	0.93
vC, conflicting volume	701				1050	700
vC1, stage 1 conf vol						
vC2, stage 2 conf vol						
vCu, unblocked vol	637				1013	635
tC, single (s)	4.1				6.4	6.2
tC, 2 stage (s)						
tF (s)	2.2				3.5	3.3
p0 queue free %	100				96	98
cM capacity (veh/h)	867				242	439
Direction, Lane #	EB 1	EB 2	WB 1	SB 1		
Volume Total	2	346	701	20		
Volume Left	2	0	0	10		
Volume Right	0	0	3	10		
cSH	867	1700	1700	312		
Volume to Capacity	0.00	0.20	0.41	0.06		
Queue Length 95th (ft)	0	0	0	5		
Control Delay (s)	9.2	0.0	0.0	17.3		
Lane LOS	A			C		
Approach Delay (s)	0.1		0.0	17.3		
Approach LOS				C		
Intersection Summary						
Average Delay			0.3			
Intersection Capacity Utilization			41.8%		ICU Level of Service	A
Analysis Period (min)			15			

HCM Signalized Intersection Capacity Analysis

4: Cahaba Road & Montevallo Road



Movement	EBL	EBT	EBR	WBL	WBT	WBR	NBL	NBT	NBR	SBL	SBT	SBR
Lane Configurations												
Traffic Volume (vph)	77	174	38	49	286	1	61	161	50	10	231	221
Future Volume (vph)	77	174	38	49	286	1	61	161	50	10	231	221
Ideal Flow (vphpl)	1900	1900	1900	1900	1900	1900	1900	1900	1900	1900	1900	1900
Total Lost time (s)	4.5	4.5		4.5	4.5		4.5	4.5		4.5	4.5	
Lane Util. Factor	1.00	1.00		1.00	1.00		1.00	1.00		1.00	1.00	
Frt	1.00	0.97		1.00	1.00		1.00	0.96		1.00	0.93	
Flt Protected	0.95	1.00		0.95	1.00		0.95	1.00		0.95	1.00	
Satd. Flow (prot)	1736	1778		1736	1826		1736	1762		1736	1693	
Flt Permitted	0.49	1.00		0.60	1.00		0.37	1.00		0.61	1.00	
Satd. Flow (perm)	903	1778		1090	1826		677	1762		1114	1693	
Peak-hour factor, PHF	0.83	0.83	0.83	0.86	0.86	0.86	0.88	0.88	0.88	0.94	0.94	0.94
Adj. Flow (vph)	93	210	46	57	333	1	69	183	57	11	246	235
RTOR Reduction (vph)	0	11	0	0	0	0	0	18	0	0	53	0
Lane Group Flow (vph)	93	245	0	57	334	0	69	222	0	11	428	0
Turn Type	Perm	NA		Perm	NA		Perm	NA		Perm	NA	
Protected Phases		4			4			2			2	
Permitted Phases	4			4			2			2		
Actuated Green, G (s)	15.8	15.8		15.8	15.8		18.8	18.8		18.8	18.8	
Effective Green, g (s)	15.8	15.8		15.8	15.8		18.8	18.8		18.8	18.8	
Actuated g/C Ratio	0.36	0.36		0.36	0.36		0.43	0.43		0.43	0.43	
Clearance Time (s)	4.5	4.5		4.5	4.5		4.5	4.5		4.5	4.5	
Vehicle Extension (s)	3.0	3.0		3.0	3.0		3.0	3.0		3.0	3.0	
Lane Grp Cap (vph)	327	644		395	661		291	759		480	730	
v/s Ratio Prot		0.14			c0.18			0.13			c0.25	
v/s Ratio Perm	0.10			0.05			0.10			0.01		
v/c Ratio	0.28	0.38		0.14	0.51		0.24	0.29		0.02	0.59	
Uniform Delay, d1	9.9	10.3		9.4	10.8		7.9	8.1		7.1	9.4	
Progression Factor	1.00	1.00		1.00	1.00		1.00	1.00		1.00	1.00	
Incremental Delay, d2	0.5	0.4		0.2	0.6		0.4	0.2		0.0	1.2	
Delay (s)	10.4	10.7		9.5	11.5		8.3	8.3		7.1	10.6	
Level of Service	B	B		A	B		A	A		A	B	
Approach Delay (s)		10.6			11.2			8.3			10.6	
Approach LOS		B			B			A			B	

Intersection Summary

HCM 2000 Control Delay	10.3	HCM 2000 Level of Service	B
HCM 2000 Volume to Capacity ratio	0.55		
Actuated Cycle Length (s)	43.6	Sum of lost time (s)	9.0
Intersection Capacity Utilization	64.2%	ICU Level of Service	C
Analysis Period (min)	15		

c Critical Lane Group

HCM Unsignalized Intersection Capacity Analysis

5: Cahaba Road & Chester Road



Movement	EBL	EBR	NBL	NBT	SBT	SBR
Lane Configurations						
Traffic Volume (veh/h)	10	5	3	269	329	3
Future Volume (Veh/h)	10	5	3	269	329	3
Sign Control	Stop			Free	Free	
Grade	0%			0%	0%	
Peak Hour Factor	0.46	0.46	0.81	0.81	0.98	0.98
Hourly flow rate (vph)	22	11	4	332	336	3
Pedestrians						
Lane Width (ft)						
Walking Speed (ft/s)						
Percent Blockage						
Right turn flare (veh)						
Median type				None	None	
Median storage (veh)						
Upstream signal (ft)					605	
pX, platoon unblocked						
vC, conflicting volume	678	338	339			
vC1, stage 1 conf vol						
vC2, stage 2 conf vol						
vCu, unblocked vol	678	338	339			
tC, single (s)	6.4	6.2	4.1			
tC, 2 stage (s)						
tF (s)	3.5	3.3	2.2			
p0 queue free %	95	98	100			
cM capacity (veh/h)	414	700	1209			
Direction, Lane #	EB 1	NB 1	NB 2	SB 1		
Volume Total	33	4	332	339		
Volume Left	22	4	0	0		
Volume Right	11	0	0	3		
cSH	479	1209	1700	1700		
Volume to Capacity	0.07	0.00	0.20	0.20		
Queue Length 95th (ft)	6	0	0	0		
Control Delay (s)	13.1	8.0	0.0	0.0		
Lane LOS	B	A				
Approach Delay (s)	13.1	0.1		0.0		
Approach LOS	B					
Intersection Summary						
Average Delay			0.7			
Intersection Capacity Utilization			27.5%	ICU Level of Service	A	
Analysis Period (min)			15			

HCM Unsignalized Intersection Capacity Analysis

6: Single Family & Montevallo Road

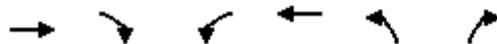

Movement	EBT	EBR	WBL	WBT	NBL	NBR
Lane Configurations	→			←	←	↘
Traffic Volume (veh/h)	187	1	1	609	2	2
Future Volume (Veh/h)	187	1	1	609	2	2
Sign Control	Free			Free	Stop	
Grade	0%			0%	0%	
Peak Hour Factor	0.91	0.91	0.86	0.86	0.50	0.50
Hourly flow rate (vph)	205	1	1	708	4	4
Pedestrians						
Lane Width (ft)						
Walking Speed (ft/s)						
Percent Blockage						
Right turn flare (veh)						
Median type	None			None		
Median storage (veh)						
Upstream signal (ft)	320					
pX, platoon unblocked						
vC, conflicting volume			206		916	206
vC1, stage 1 conf vol						
vC2, stage 2 conf vol						
vCu, unblocked vol			206		916	206
tC, single (s)			4.1		6.4	6.2
tC, 2 stage (s)						
tF (s)			2.2		3.5	3.3
p0 queue free %			100		99	100
cM capacity (veh/h)			1353		300	830
Direction, Lane #	EB 1	WB 1	NB 1			
Volume Total	206	709	8			
Volume Left	0	1	4			
Volume Right	1	0	4			
cSH	1700	1353	441			
Volume to Capacity	0.12	0.00	0.02			
Queue Length 95th (ft)	0	0	1			
Control Delay (s)	0.0	0.0	13.3			
Lane LOS			A			B
Approach Delay (s)	0.0	0.0	13.3			
Approach LOS			B			
Intersection Summary						
Average Delay			0.1			
Intersection Capacity Utilization			42.8%	ICU Level of Service	A	
Analysis Period (min)			15			

HCM Unsignalized Intersection Capacity Analysis

7: Condo Access & Montevallo Road



Movement	EBT	EBR	WBL	WBT	NBL	NBR
Lane Configurations	→			←	←	↘
Traffic Volume (veh/h)	189	1	1	608	4	6
Future Volume (Veh/h)	189	1	1	608	4	6
Sign Control	Free			Free	Stop	
Grade	0%			0%	0%	
Peak Hour Factor	0.91	0.91	0.86	0.86	0.50	0.50
Hourly flow rate (vph)	208	1	1	707	8	12
Pedestrians						
Lane Width (ft)						
Walking Speed (ft/s)						
Percent Blockage						
Right turn flare (veh)						
Median type	None			None		
Median storage (veh)						
Upstream signal (ft)	782			1299		
pX, platoon unblocked						
vC, conflicting volume			209	918		208
vC1, stage 1 conf vol						
vC2, stage 2 conf vol						
vCu, unblocked vol			209	918		208
tC, single (s)			4.1	6.4		6.2
tC, 2 stage (s)						
tF (s)			2.2	3.5		3.3
p0 queue free %			100	97		99
cM capacity (veh/h)			1350	299		827
Direction, Lane #	EB 1	WB 1	NB 1			
Volume Total	209	708	20			
Volume Left	0	1	8			
Volume Right	1	0	12			
cSH	1700	1350	485			
Volume to Capacity	0.12	0.00	0.04			
Queue Length 95th (ft)	0	0	3			
Control Delay (s)	0.0	0.0	12.7			
Lane LOS			A	B		
Approach Delay (s)	0.0	0.0	12.7			
Approach LOS			B			
Intersection Summary						
Average Delay			0.3			
Intersection Capacity Utilization			42.8%	ICU Level of Service	A	
Analysis Period (min)			15			

HCM Unsignalized Intersection Capacity Analysis

1: US-280 Entrance Ramp & Hollywood Blvd



Movement	EBT	EBR	WBL	WBT	NBL	NBR
Lane Configurations	↻		↻	↻		
Traffic Volume (veh/h)	287	181	387	321	0	0
Future Volume (Veh/h)	287	181	387	321	0	0
Sign Control	Free			Free	Stop	
Grade	0%			0%	0%	
Peak Hour Factor	0.95	0.95	0.92	0.92	0.92	0.92
Hourly flow rate (vph)	302	191	421	349	0	0
Pedestrians						
Lane Width (ft)						
Walking Speed (ft/s)						
Percent Blockage						
Right turn flare (veh)						
Median type	None		None			
Median storage (veh)						
Upstream signal (ft)	260					
pX, platoon unblocked						
vC, conflicting volume			302		1588	398
vC1, stage 1 conf vol						
vC2, stage 2 conf vol						
vCu, unblocked vol			302		1588	398
tC, single (s)			4.1		6.4	6.2
tC, 2 stage (s)						
tF (s)			2.2		3.5	3.3
p0 queue free %			66		100	100
cM capacity (veh/h)			1248		78	648
Direction, Lane #	EB 1	WB 1	WB 2			
Volume Total	493	421	349			
Volume Left	0	421	0			
Volume Right	191	0	0			
cSH	1700	1248	1700			
Volume to Capacity	0.29	0.34	0.21			
Queue Length 95th (ft)	0	38	0			
Control Delay (s)	0.0	9.3	0.0			
Lane LOS	A					
Approach Delay (s)	0.0	5.1				
Approach LOS						
Intersection Summary						
Average Delay			3.1			
Intersection Capacity Utilization			54.3%	ICU Level of Service	A	
Analysis Period (min)	15					

HCM Signalized Intersection Capacity Analysis

2: US-280 Exit Ramp & Hollywood Blvd/Montevallo Road

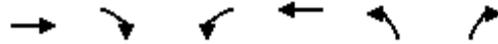

Movement	EBT	EBR	WBL	WBT	NBL	NBR
Lane Configurations	↑			↑	↘	↗
Traffic Volume (vph)	284	0	0	556	114	161
Future Volume (vph)	284	0	0	556	114	161
Ideal Flow (vphpl)	1900	1900	1900	1900	1900	1900
Total Lost time (s)	4.5			4.5	4.5	4.5
Lane Util. Factor	1.00			1.00	1.00	1.00
Frt	1.00			1.00	1.00	0.85
Flt Protected	1.00			1.00	0.95	1.00
Satd. Flow (prot)	1827			1827	1736	1553
Flt Permitted	1.00			1.00	0.95	1.00
Satd. Flow (perm)	1827			1827	1736	1553
Peak-hour factor, PHF	0.91	0.91	0.92	0.92	0.90	0.90
Adj. Flow (vph)	312	0	0	604	127	179
RTOR Reduction (vph)	0	0	0	0	0	147
Lane Group Flow (vph)	312	0	0	604	127	32
Turn Type	NA			NA	Prot	Perm
Protected Phases	2			2	4	
Permitted Phases						4
Actuated Green, G (s)	24.0			24.0	7.1	7.1
Effective Green, g (s)	24.0			24.0	7.1	7.1
Actuated g/C Ratio	0.60			0.60	0.18	0.18
Clearance Time (s)	4.5			4.5	4.5	4.5
Vehicle Extension (s)	3.0			3.0	3.0	3.0
Lane Grp Cap (vph)	1093			1093	307	274
v/s Ratio Prot	0.17			c0.33	c0.07	
v/s Ratio Perm						0.02
v/c Ratio	0.29			0.55	0.41	0.12
Uniform Delay, d1	3.9			4.8	14.7	13.9
Progression Factor	1.00			1.00	1.00	1.00
Incremental Delay, d2	0.1			0.6	0.9	0.2
Delay (s)	4.0			5.4	15.6	14.1
Level of Service	A			A	B	B
Approach Delay (s)	4.0			5.4	14.7	
Approach LOS	A			A	B	

Intersection Summary

HCM 2000 Control Delay	7.4	HCM 2000 Level of Service	A
HCM 2000 Volume to Capacity ratio	0.52		
Actuated Cycle Length (s)	40.1	Sum of lost time (s)	9.0
Intersection Capacity Utilization	54.3%	ICU Level of Service	A
Analysis Period (min)	15		

c Critical Lane Group

3: Montevallo Road & Brookhill

06/10/2022



Movement	EBL	EBT	WBT	WBR	SBL	SBR
Lane Configurations						
Traffic Volume (veh/h)	8	431	584	5	7	13
Future Volume (Veh/h)	8	431	584	5	7	13
Sign Control		Free	Free		Stop	
Grade		0%	0%		0%	
Peak Hour Factor	0.87	0.87	0.89	0.89	0.63	0.63
Hourly flow rate (vph)	9	495	656	6	11	21
Pedestrians						
Lane Width (ft)						
Walking Speed (ft/s)						
Percent Blockage						
Right turn flare (veh)						
Median type		None	None			
Median storage (veh)						
Upstream signal (ft)		1280	801			
pX, platoon unblocked	0.96				0.96	0.96
vC, conflicting volume	662				1172	659
vC1, stage 1 conf vol						
vC2, stage 2 conf vol						
vCu, unblocked vol	628				1159	625
tC, single (s)	4.1				6.4	6.2
tC, 2 stage (s)						
tF (s)	2.2				3.5	3.3
p0 queue free %	99				95	95
cM capacity (veh/h)	908				204	462

Direction, Lane #	EB 1	EB 2	WB 1	SB 1
Volume Total	9	495	662	32
Volume Left	9	0	0	11
Volume Right	0	0	6	21
cSH	908	1700	1700	322
Volume to Capacity	0.01	0.29	0.39	0.10
Queue Length 95th (ft)	1	0	0	8
Control Delay (s)	9.0	0.0	0.0	17.4
Lane LOS	A			C
Approach Delay (s)	0.2		0.0	17.4
Approach LOS				C

Intersection Summary			
Average Delay		0.5	
Intersection Capacity Utilization		41.0%	ICU Level of Service A
Analysis Period (min)		15	

HCM Signalized Intersection Capacity Analysis

4: Cahaba Road & Montevallo Road



Movement	EBL	EBT	EBR	WBL	WBT	WBR	NBL	NBT	NBR	SBL	SBT	SBR
Lane Configurations												
Traffic Volume (vph)	104	322	44	50	239	1	63	238	113	23	224	223
Future Volume (vph)	104	322	44	50	239	1	63	238	113	23	224	223
Ideal Flow (vphpl)	1900	1900	1900	1900	1900	1900	1900	1900	1900	1900	1900	1900
Total Lost time (s)	4.5	4.5		4.5	4.5		4.5	4.5		4.5	4.5	
Lane Util. Factor	1.00	1.00		1.00	1.00		1.00	1.00		1.00	1.00	
Frt	1.00	0.98		1.00	1.00		1.00	0.95		1.00	0.93	
Flt Protected	0.95	1.00		0.95	1.00		0.95	1.00		0.95	1.00	
Satd. Flow (prot)	1736	1794		1736	1826		1736	1738		1736	1690	
Flt Permitted	0.55	1.00		0.41	1.00		0.35	1.00		0.46	1.00	
Satd. Flow (perm)	1012	1794		748	1826		633	1738		836	1690	
Peak-hour factor, PHF	0.93	0.93	0.93	0.87	0.87	0.87	0.90	0.90	0.90	0.89	0.89	0.89
Adj. Flow (vph)	112	346	47	57	275	1	70	264	126	26	252	251
RTOR Reduction (vph)	0	7	0	0	0	0	0	25	0	0	53	0
Lane Group Flow (vph)	112	386	0	57	276	0	70	365	0	26	450	0
Turn Type	Perm	NA		Perm	NA		Perm	NA		Perm	NA	
Protected Phases		4			4			2			2	
Permitted Phases	4			4			2			2		
Actuated Green, G (s)	18.3	18.3		18.3	18.3		22.0	22.0		22.0	22.0	
Effective Green, g (s)	18.3	18.3		18.3	18.3		22.0	22.0		22.0	22.0	
Actuated g/C Ratio	0.37	0.37		0.37	0.37		0.45	0.45		0.45	0.45	
Clearance Time (s)	4.5	4.5		4.5	4.5		4.5	4.5		4.5	4.5	
Vehicle Extension (s)	3.0	3.0		3.0	3.0		3.0	3.0		3.0	3.0	
Lane Grp Cap (vph)	375	665		277	677		282	775		373	754	
v/s Ratio Prot		c0.22			0.15			0.21			c0.27	
v/s Ratio Perm	0.11			0.08			0.11			0.03		
v/c Ratio	0.30	0.58		0.21	0.41		0.25	0.47		0.07	0.60	
Uniform Delay, d1	11.0	12.4		10.6	11.5		8.5	9.6		7.8	10.3	
Progression Factor	1.00	1.00		1.00	1.00		1.00	1.00		1.00	1.00	
Incremental Delay, d2	0.4	1.3		0.4	0.4		0.5	0.5		0.1	1.3	
Delay (s)	11.4	13.7		10.9	11.9		9.0	10.0		7.9	11.6	
Level of Service	B	B		B	B		A	B		A	B	
Approach Delay (s)		13.2			11.7			9.9			11.4	
Approach LOS		B			B			A			B	

Intersection Summary

HCM 2000 Control Delay	11.6	HCM 2000 Level of Service	B
HCM 2000 Volume to Capacity ratio	0.59		
Actuated Cycle Length (s)	49.3	Sum of lost time (s)	9.0
Intersection Capacity Utilization	68.4%	ICU Level of Service	C
Analysis Period (min)	15		

c Critical Lane Group

HCM Unsignalized Intersection Capacity Analysis

5: Cahaba Road & Chester Road



Movement	EBL	EBR	NBL	NBT	SBT	SBR
Lane Configurations						
Traffic Volume (veh/h)	5	4	7	366	335	6
Future Volume (Veh/h)	5	4	7	366	335	6
Sign Control	Stop			Free	Free	
Grade	0%			0%	0%	
Peak Hour Factor	0.75	0.75	0.87	0.87	0.89	0.89
Hourly flow rate (vph)	7	5	8	421	376	7
Pedestrians						
Lane Width (ft)						
Walking Speed (ft/s)						
Percent Blockage						
Right turn flare (veh)						
Median type				None	None	
Median storage (veh)						
Upstream signal (ft)					605	
pX, platoon unblocked						
vC, conflicting volume	816	380	383			
vC1, stage 1 conf vol						
vC2, stage 2 conf vol						
vCu, unblocked vol	816	380	383			
tC, single (s)	6.4	6.2	4.1			
tC, 2 stage (s)						
tF (s)	3.5	3.3	2.2			
p0 queue free %	98	99	99			
cM capacity (veh/h)	341	663	1165			
Direction, Lane #	EB 1	NB 1	NB 2	SB 1		
Volume Total	12	8	421	383		
Volume Left	7	8	0	0		
Volume Right	5	0	0	7		
cSH	428	1165	1700	1700		
Volume to Capacity	0.03	0.01	0.25	0.23		
Queue Length 95th (ft)	2	1	0	0		
Control Delay (s)	13.7	8.1	0.0	0.0		
Lane LOS	B	A				
Approach Delay (s)	13.7	0.2		0.0		
Approach LOS	B					
Intersection Summary						
Average Delay			0.3			
Intersection Capacity Utilization			29.3%		ICU Level of Service	A
Analysis Period (min)			15			

HCM Unsignalized Intersection Capacity Analysis

6: Single Family & Montevallo Road



Movement	EBT	EBR	WBL	WBT	NBL	NBR
Lane Configurations	↻			↻	↻	
Traffic Volume (veh/h)	287	2	2	554	1	1
Future Volume (Veh/h)	287	2	2	554	1	1
Sign Control	Free			Free	Stop	
Grade	0%			0%	0%	
Peak Hour Factor	0.87	0.87	0.89	0.89	0.63	0.63
Hourly flow rate (vph)	330	2	2	622	2	2
Pedestrians						
Lane Width (ft)						
Walking Speed (ft/s)						
Percent Blockage						
Right turn flare (veh)						
Median type	None			None		
Median storage (veh)						
Upstream signal (ft)	380					
pX, platoon unblocked						
vC, conflicting volume			332	957		331
vC1, stage 1 conf vol						
vC2, stage 2 conf vol						
vCu, unblocked vol			332	957		331
tC, single (s)			4.1	6.4		6.2
tC, 2 stage (s)						
tF (s)			2.2	3.5		3.3
p0 queue free %			100	99		100
cM capacity (veh/h)			1216	283		706
Direction, Lane #	EB 1	WB 1	NB 1			
Volume Total	332	624	4			
Volume Left	0	2	2			
Volume Right	2	0	2			
cSH	1700	1216	404			
Volume to Capacity	0.20	0.00	0.01			
Queue Length 95th (ft)	0	0	1			
Control Delay (s)	0.0	0.0	14.0			
Lane LOS	A		B			
Approach Delay (s)	0.0	0.0	14.0			
Approach LOS	A		B			
Intersection Summary						
Average Delay			0.1			
Intersection Capacity Utilization			40.7%	ICU Level of Service		A
Analysis Period (min)	15					

HCM Unsignalized Intersection Capacity Analysis

7: Condo Access & Montevallo Road



Movement	EBT	EBR	WBL	WBT	NBL	NBR
Lane Configurations	↔			↔	↔	
Traffic Volume (veh/h)	284	4	6	554	2	4
Future Volume (Veh/h)	284	4	6	554	2	4
Sign Control	Free			Free	Stop	
Grade	0%			0%	0%	
Peak Hour Factor	0.87	0.87	0.89	0.89	0.63	0.63
Hourly flow rate (vph)	326	5	7	622	3	6
Pedestrians						
Lane Width (ft)						
Walking Speed (ft/s)						
Percent Blockage						
Right turn flare (veh)						
Median type	None			None		
Median storage (veh)						
Upstream signal (ft)	900			1181		
pX, platoon unblocked						
vC, conflicting volume			331	964		328
vC1, stage 1 conf vol						
vC2, stage 2 conf vol						
vCu, unblocked vol			331	964		328
tC, single (s)			4.1	6.4		6.2
tC, 2 stage (s)						
tF (s)			2.2	3.5		3.3
p0 queue free %			99	99		99
cM capacity (veh/h)			1217	279		708
Direction, Lane #	EB 1	WB 1	NB 1			
Volume Total	331	629	9			
Volume Left	0	7	3			
Volume Right	5	0	6			
cSH	1700	1217	468			
Volume to Capacity	0.19	0.01	0.02			
Queue Length 95th (ft)	0	0	1			
Control Delay (s)	0.0	0.2	12.8			
Lane LOS	A		B			
Approach Delay (s)	0.0	0.2	12.8			
Approach LOS	A		B			
Intersection Summary						
Average Delay			0.2			
Intersection Capacity Utilization			43.9%	ICU Level of Service	A	
Analysis Period (min)			15			

APPENDIX E
SUBDIVISION COVENANTS

Declaration Of Covenants, Easements, Conditions, And Restrictions
of
[XYZ] Subdivision
_____, **2022**

THIS INSTRUMENT PREPARED BY:
Melinda E. Sellers
Burr & Forman LLP
420 North 20th Street, Suite 3400
Birmingham, AL 35203
(205) 251-3000

TABLE OF CONTENTS**TABLE OF CONTENTS**

	<u>Page</u>
ARTICLE I DEFINITIONS	7
Section 1.1 Additional Property.....	7
Section 1.2 Annual Assessments.	7
Section 1.3 ARC.	7
Section 1.4 Architectural Standards.....	7
Section 1.5 Assessment.....	8
Section 1.6 Association.....	8
Section 1.7 Board.....	8
Section 1.8 Bylaws.....	8
Section 1.9 Certificate of Formation.....	8
Section 1.10 Common Areas.	8
Section 1.11 Common Expenses.....	9
Section 1.12 Declaration.....	9
Section 1.13 Developer.....	9
Section 1.14 Developer Control Period.	9
Section 1.15 Governmental Authority.	9
Section 1.16 Improvement.	9
Section 1.17 Individual Assessment.	9
Section 1.18 Lot.....	9
Section 1.19 Member.....	10
Section 1.20 Mortgage.....	10
Section 1.21 Mortgagee.....	10
Section 1.22 Occupant.	10
Section 1.23 Owner.....	10
Section 1.24 Probate Office.	10
Section 1.25 Property.....	10
Section 1.26 Rules and Regulations.....	10
Section 1.27 Single Family Unit.....	10
Section 1.28 Special Assessments.	10
Section 1.29 Subdivision.	10

Section 1.30	Subdivision Record Map.....	11
ARTICLE II RESTRICTIONS APPLICABLE TO THE PROPERTY		11
Section 2.1	General Declaration.	11
Section 2.2	Additional Property.....	11
Section 2.3	Right of Developer to Modify Restrictions with Respect to Lots Owned by Developer.	11
Section 2.4	Mutuality of Benefit and Obligation.....	12
Section 2.5	Development of Property.....	12
Section 2.6	Subdivision Record Map.....	12
Section 2.7	Parking.....	13
ARTICLE III ORGANIZATION AND MANAGEMENT OF THE ASSOCIATION		13
Section 3.1	Members.	13
Section 3.2	Association Insurance Requirements.....	13
ARTICLE IV EASEMENTS		13
Section 4.1	Grant of Nonexclusive Easements to Owners: Subject to the terms and conditions of this Declaration and the Rules and Regulations from time to time established by the Association with respect to the Common Areas and Easement for Ingress and Egress, Developer does hereby grant to each Owner and Occupant the nonexclusive right, privilege, and easement of access to and the use and enjoyment of the Common Areas and for purposes of ingress and egress to the Lots, an easement for ingress and egress as shown on the Subdivision Record Map (“Easement for Ingress and Egress”) in common with all other Owners and Occupants and their parties having a right or interest therein and their respective successors and/or assigns.....	13
Section 4.2	Utility Easements.....	14
Section 4.3	Additional Easements and Uses.....	14
Section 4.4	Reservation of General Access Easement.....	14
Section 4.5	Reservation of Easements With Respect to Common Areas.....	15
Section 4.6	Additional Documents.	15
Section 4.7	Limitations.....	15
ARTICLE V ARCHITECTURAL CONTROL.....		16
Section 5.1	Architectural Control.	16
Section 5.2	Architectural Standards.....	16
Section 5.3	Approval of Plans and Specifications.....	17
Section 5.4	Construction Without Approval.....	19
Section 5.5	Inspection.....	19
Section 5.6	Limitation of Liability.....	19
Section 5.7	Enforcement and Remedies.	20

ARTICLE VI RESTRICTIONS	20
Section 6.1 Rules and Regulations of the Association.	20
Section 6.2 Restrictions on Use.	21
Section 6.3 Landscaping.	23
Section 6.4 Storm Drains.	24
Section 6.5 Exterior Lighting.....	24
Section 6.6 Exterior Materials and Finishes.	24
Section 6.7 Fences.	24
Section 6.8 Windows, Window Treatments and Doors.	24
Section 6.9 Mailboxes.....	24
Section 6.10 Outdoor Furniture and Recreational Facilities.....	24
Section 6.11 Trash, Rubbish and Nuisances.	25
Section 6.12 Recreational Vehicles and Machinery and Equipment.	25
Section 6.13 Signage.....	26
Section 6.14 Construction of Improvements.	26
Section 6.15 Swimming Pools.	27
Section 6.16 Traffic Regulations.	27
Section 6.17 Lease of Lots.	27
Section 6.18 Right of Access.	27
Section 6.19 Limitation of Liability.....	28
Section 6.20 Enforcement.	28
Section 6.21 Failure of the Association to Insist on Strict Performance; No Waiver.	28
Section 6.22 Use by Developer.....	29
Section 6.23 Common Areas.	29
Section 6.24 Compliance with Governmental Regulations.	29
Section 6.25 Additional Regulations.	29
ARTICLE VII COVENANT FOR ASSESSMENTS.....	29
Section 7.1 Affirmative Covenant to Pay Assessments.....	29
Section 7.2 Purpose of Assessments.....	30
Section 7.3 Individual Assessment.	30
Section 7.4 Annual Assessments.	30
Section 7.5 Special Assessments.	30
Section 7.6 Special Meeting.	31
Section 7.7 Amount of Assessments.....	31

Section 7.8	Certificate.....	31
Section 7.9	Effect of Non-Payment of Assessments; Liens; Remedies.....	31
Section 7.10	Damages.....	32
Section 7.11	Exempt Property.	33
ARTICLE VIII MAINTENANCE RESPONSIBILITIES		33
Section 8.1	Responsibilities of Owners -Maintenance.	33
Section 8.2	Responsibilities of Owners - Utilities.....	34
Section 8.3	Responsibilities of Association – Maintenance.	34
Section 8.4	Responsibilities of Association - Common Expenses.	34
Section 8.5	Reserves.	35
Section 8.6	Interested Transactions.	35
ARTICLE IX ENFORCEMENT OF PROTECTIVE COVENANTS, DEFAULTS AND REMEDIES.....		35
Section 9.1	Covenants Running with the Land.....	35
Section 9.2	Remedies for Default.	36
Section 9.3	Nature of Remedies: Waiver.....	36
Section 9.4	Attorneys’ Fees and Costs.	36
Section 9.5	No Reverter.	36
ARTICLE X AMENDMENT OF DECLARATION		36
Section 10.1	Amendment by Association.....	36
Section 10.2	Scrivener’s Error.....	37
ARTICLE XI PERIOD OF DEVELOPER CONTROL.....		37
Section 11.1	Developer Control.....	37
ARTICLE XII GENERAL PROVISIONS.....		38
Section 12.1	Deeds Subject to Covenant.	38
Section 12.2	Obligation of Owner to Build or Restore.....	38
Section 12.3	No Trespass.....	38
Section 12.4	Notices.	38
Section 12.5	Severability.	38
Section 12.6	Governing Law.	38
Section 12.7	Captions.	38
Section 12.8	Usage.....	38
Section 12.9	Conflict.	38
Section 12.10	Effective Date.	39

**DECLARATION OF COVENANTS, EASEMENTS, CONDITIONS AND
RESTRICTIONS OF [XYZ] SUBDIVISION**

THIS DECLARATION OF COVENANTS, EASEMENTS, CONDITIONS AND RESTRICTIONS FOR [XYZ] SUBDIVISION (this “Declaration”) is made as of the __ day of _____, 202__ by [_____], LLC, an Alabama limited liability company (the “Developer”).

RECITALS:

WHEREAS, Developer is the owner of certain real property situated in Jefferson County, Alabama, more particularly described on Exhibit “A” attached hereto (the “Property”). Developer intends to develop, improve, lease and sell the Property for residential uses, subject to certain easements, covenants, conditions, restrictions, requirements, and obligations, in order to protect the value and desirability of the Property and to have a flexible and reasonable method for the development, administration, and maintenance of the Property.

NOW, THEREFORE, Developer, upon the recording hereof, does hereby declare that all of the Property shall be held, developed, improved, transferred, sold, conveyed, leased, occupied and used subject to the easements, covenants, conditions, restrictions, requirements and obligations hereafter set forth as applicable to the Property, which shall be binding upon and inure to the benefit of all parties acquiring or having any right, title or interest in any portion of the Property and their respective heirs, executors, administrators, personal representatives, successors and assigns.

**ARTICLE I
DEFINITIONS**

As used in this Declaration, the following initially capitalized terms shall have the following meanings, which meanings shall be applicable to both the singular and plural forms and tenses of such terms:

Section 1.1 Additional Property. The term “Additional Property” shall mean and refer to any real property and any Improvements situated thereon lying adjacent to or in close proximity with the Property (but which does not presently comprise any part of the Property) which Developer may from time to time submit and add to the provisions of this Declaration pursuant to the provisions of Section 2.2 below. The Additional Property may also include additional Common Areas.

Section 1.2 Annual Assessments. The term “Annual Assessment” shall have the meaning ascribed to it in Section 6.4 hereof.

Section 1.3 ARC. The term “ARC” shall mean the Architectural Review Committee appointed pursuant to Article IV hereof with the rights and obligations conferred upon such Architectural Review Committee pursuant to this Declaration.

Section 1.4 Architectural Standards. The term “Architectural Standards” shall mean the standards prepared, issued and amended from time to time by the ARC pursuant to

Article IV below for the purpose of establishing policies, guidelines and minimum requirements with regard to the construction, location, landscaping, design, architectural style and any other matters relating to the construction, repair, replacement and alteration of Improvements on the Lots. The Developer shall work with the City of [_____] to develop these standards for the Lots. In addition, the term “Architectural Standards” shall include, without limitation, any additional construction and development guidelines adopted from time to time by the ARC or the Board.

Section 1.5 Assessment. The term “Assessment” shall mean the assessments to be assessed against the Owners pursuant to the authority vested in the Association, and such term shall include the Annual Assessments, Special Assessments and Individual Assessments.

Section 1.6 Association. The term “Association” shall mean [XYZ] Subdivision Association, Inc., an Alabama non-profit corporation, and its successors and assigns.

Section 1.7 Board. The term “Board” shall mean the Board of Directors of the Association and their duly elected successors as may be provided in the Certificate of Formation and Bylaws.

Section 1.8 Bylaws. The term “Bylaws” shall mean the Bylaws of the Association attached hereto as Exhibit “B”, as such Bylaws may be amended from time to time.

Section 1.9 Certificate of Formation. The term “Certificate of Formation” shall mean the Certificate of Formation of the Association, filed with the Secretary of State and having the Entity Number _____, as said Certificate may be amended from time to time.

Section 1.10 Common Areas. The term “Common Areas” shall mean and refer to all real and/or personal property, including property which the Association now or hereafter owns or otherwise acquires by lease, easement or otherwise, for the common use and enjoyment of the Owners, and which shall be the responsibility of the Association to maintain, and which shall include, without limitation, the following: (a) all signage for the Property situated on or within any entrance easement, within private roads, or rights-of-way of any public roads within the Property (but specifically excluding any signage located within the boundaries of any Lot unless an easement has been granted to (and accepted by) Developer or the Association for signage on such Lot), including, without limitation, informational, traffic and street signage; (b) any street or roadway and landscaping lighting situated within the right-of-way of any streets within any portion of the Property (to the extent the same are not being maintained by any Governmental Authority); (c) all sidewalks, paths and on-street parking spaces, if any, situated within any portion of the Property (other than such areas located within the boundary lines of any Lot or which are maintained by any Governmental Authority); (d) all gates, walls, fences, Improvements, landscaping and landscaped areas situated within the Common Areas or rights-of-way of any public roadways within the Property, (e) all water features, storm drains and sewers, drainage and/or watershed protection or retention ponds, basins or other areas and facilities located within the Property (other than such areas located within the boundary lines of any Lot or which are maintained by any Governmental Authority); (f) all utility and irrigation lines, pipes, ducts, conduits, equipment, machinery and other apparatus and appurtenances which serve any portion of the Common Areas (which are not owned or maintained by any public or private utility

providers or any Governmental Authorities), including sanitary sewer pumping stations; (g) any and all other areas designated on any Subdivision Record Map as a “Common Area”; and (h) any other areas or Improvements on or within the Property which are designated by Developer as Common Areas from time to time. The designation of any land and/or Improvements as Common Areas shall not mean or imply that the public at large acquires any easement of use or enjoyment or any other rights, licenses or benefits therein or to the use thereof.

Section 1.11 Common Expenses. The term “Common Expenses” shall mean and refer to all expenditures made or incurred by or on behalf of the Association, including, without limitation, those expenses described in Section 7.5 below, together with all funds assessed for the creation or maintenance of reserves pursuant to the provisions of this Declaration.

Section 1.12 Declaration. The term “Declaration” shall mean and refer to this Declaration of Covenants, Easements, Conditions and Restrictions for [XYZ] Subdivision, together with all amendments thereto.

Section 1.13 Developer. The term “Developer” shall mean [_____], LLC, an Alabama limited liability company, and its successors and assigns, if such successors or assigns acquire any portion of the Property and are designated as successor developer by Developer.

Section 1.14 Developer Control Period. The term “Developer Control Period” shall have the meaning ascribed to it in Section 11.1 hereof.

Section 1.15 Governmental Authority. The term “Governmental Authority” shall mean and refer to any and all city, county, state and federal governmental or quasi-governmental agencies, bureaus, departments, divisions or regulatory authorities having jurisdiction over any portion of the Property or any Improvements thereto.

Section 1.16 Improvement. The term “Improvement” shall mean and refer to any dwellings, any building, structure, planting or device constructed, erected or placed upon any Lot or Common Area which in any way affects the exterior appearance of any Lot or Common Area. Improvements shall include, by way of illustration and not limitation, buildings, sheds, foundations, covered patios, underground utilities, roads, driveways, walkways, paving, curbing, parking areas, trees, shrubbery, landscaping, fences, screening, walls, signs, and any other artificial or man-made changes or alterations to the natural condition of any Lot.

Section 1.17 Individual Assessment. The term “Individual Assessment” shall have the meaning ascribed to it in Section 6.3 hereof.

Section 1.18 Lot. The term “Lot” shall mean and refer to any portion of the Property upon which it is intended that a dwelling be constructed thereon. Upon the recordation of any Subdivision Record Map for any portion of the Property, each Lot indicated thereon (other than any Lots designated thereon as Common Areas or which subsequently become Common Areas) shall be deemed a Lot for purposes of this Declaration; provided, however, that a Lot may be unplatted and may be described by metes and bounds legal description.

Section 1.19 Member. The term “Member” shall mean any person who is a member of the Association. Every Owner shall be a Member of the Association.

Section 1.20 Mortgage. The term “Mortgage” shall mean any first mortgage encumbering a Lot or any interest therein and which shall have been duly and properly recorded in the Probate Office.

Section 1.21 Mortgagee. The term “Mortgagee” shall mean the holder of any first Mortgage.

Section 1.22 Occupant. The term “Occupant” shall mean and include any Owner, the family members, guests, tenants, agents, employees or invitees of any Owner and their respective family members, guests, tenants, agents, employees, invitees and any other person who occupies or uses any dwelling within the Subdivision. All action or omission of any Occupant is and shall be deemed the action or omission of the Owner of such dwelling.

Section 1.23 Owner. The term “Owner” shall mean and refer to the record owner, including Developer, of fee simple title to any Lot, whether a corporation, partnership, proprietorship, association or other entity of any nature, including natural persons, but shall not include (i) any Mortgagee of Lot, unless and until such Mortgagee has foreclosed on its Mortgage and purchased such Lot or dwelling at the foreclosure sale held with respect to the foreclosure of such Mortgage or accepted a deed in lieu of foreclosure or (ii) any lessee, purchaser, contract purchaser or vendor who has an interest in any Lot solely by virtue of a lease, contract, installment contract or other agreement.

Section 1.24 Probate Office. The term “Probate Office” shall mean and refer to the Office of the Judge of Probate of Jefferson County, Alabama, and any successors thereto which serves as the official public registry for the public recording of real estate documents in Jefferson County, Alabama.

Section 1.25 Property. The term “Property” shall mean and refer to the real property more particularly described on Exhibit “A” attached hereto, including all the Lots described on Exhibit “A” and all easements as reflected on the Subdivision Record Map.

Section 1.26 Rules and Regulations. The term “Rules and Regulations” shall mean those Rules and Regulations adopted from time to time by the Board of Directors that are deemed necessary for the enjoyment of the Property.

Section 1.27 Single Family Unit. The term “Single Family Unit” shall mean a group of one or more persons each related to the other by marriage or legal adoption, or a group of not more than three persons not all so related, who maintain a common household in a dwelling.

Section 1.28 Special Assessments. The term “Special Assessments” shall have the meaning ascribed to it in Section 6.5 hereof.

Section 1.29 Subdivision. The term “Subdivision” shall mean [XYZ] Subdivision as shown on the Subdivision Record Map, as may be amended from time to time.

Section 1.30 Subdivision Record Map. The term “Subdivision Record Map” shall mean each recorded map or plat for one or more phases of [XYZ] Subdivision, each as shall be recorded in the Probate Office, and any amendments or supplements thereof.

ARTICLE II RESTRICTIONS APPLICABLE TO THE PROPERTY

Section 2.1 General Declaration. Developer hereby declares that the Property is and shall be subject to the easements, covenants, conditions, restrictions, charges, liens and regulations of this Declaration and the Property, any part thereof and each Lot thereof shall be held, owned, sold, transferred, conveyed, hypothecated, encumbered, leased, occupied, built upon and otherwise used, improved and maintained subject to the terms of this Declaration, which easements, covenants, conditions, restrictions, charges, liens and regulations shall run with the title to such Property and shall be binding upon and inure to the benefit of Developer and upon all Owners and Occupants of the Property and any Lot thereof. This Declaration shall not apply to any other real property owned by Developer unless the same is subjected specifically by written instrument to this Declaration in accordance with Section 2.2 hereof.

Section 2.2 Additional Property. Developer reserves the right, in its sole and absolute discretion and without the consent of the Association, the Owners, Occupants, or Mortgagees of any Lot or dwelling, at any time and from time to time during the pendency of this Declaration, to add and submit any Additional Property to the provisions of this Declaration and, to the extent any of the Additional Property is specifically submitted to the terms and provisions of this Declaration by Developer, then any such Additional Property shall constitute part of the Property. Additional Property may be submitted to the provisions of this Declaration by an instrument executed by Developer in the manner required for the execution of deeds and recorded in the Probate Office, which instrument shall be deemed an amendment to this Declaration (which need not be consented to or approved by any Owner, Occupant or Mortgagee of any Lot) and shall (a) refer to this Declaration stating the Instrument Number in the Probate Office where this Declaration is recorded, (b) contain a statement that such Additional Property is subject to the provisions of this Declaration, (c) contain a legal description of such Additional Property and (d) state such other or different covenants, conditions and restrictions as the Developer, in its sole discretion, shall specify to regulate and control the use, occupancy and improvement of such Additional Property. In no event shall Developer be obligated to submit any Additional Property to the provisions of this Declaration or to impose any of the covenants, conditions or restrictions set forth in this Declaration upon any real property owned by Developer situated adjacent to or in close proximity with the Subdivision. Notwithstanding anything provided in this Declaration to the contrary, (1) the provisions of this Section 2.2 may not be abrogated, modified, rescinded, supplemented or amended, in whole or in part, without the prior written consent of Developer and (2) the rights reserved by Developer pursuant to this Section 2.2 shall not be deemed to inure to the benefit of any transferee or purchaser of the Additional Property or any portion thereof, unless Developer, in its sole discretion, transfers and conveys to such transferee or purchaser the rights reserved herein by express reference to Section 2.2 of this Declaration.

Section 2.3 Right of Developer to Modify Restrictions with Respect to Lots Owned by Developer. With respect to any Lot owned by Developer, Developer may, by deed, contract or other instrument filed for record in the manner specified in Section 2.2 above, modify

the provisions of this Declaration as the same apply to any such Lot, without the consent of the Association, or by any Owner, Occupant, or Mortgagee of any Lot or dwelling thereon.

Section 2.4 Mutuality of Benefit and Obligation. The provisions of this Declaration are made (a) for the mutual and reciprocal benefit of each Lot within the Property and are intended to create mutual, equitable servitudes upon and in favor of each Lot, (b) to create reciprocal rights and obligations between the respective Owners, Occupants and all future and subsequent Owners and Occupants of any Lot within the Property, and (c) to create a privity of contract and estate between the Owners and Occupants, their respective heirs, successors and assigns.

Section 2.5 Development of Property. At any time during the Developer Control Period and at any time thereafter for so long as Developer owns any portion of the Property, Developer shall have the right to make improvements and changes to all Common Areas and to all Lots owned by Developer, including, without limitation, (a) installing and maintaining any Improvements in or to the Common Areas, (b) changing the location of the boundaries of any Lots owned by Developer or the boundaries of any of the Common Areas, (c) changing the boundaries of any portion of the Property owned by Developer including any Additional Property owned by Developer, (d) installing and maintaining any water, sanitary sewer, storm sewer and any other utility systems and facilities within any of the Common Areas, (e) converting and changing any Lots or any portion thereof owned by Developer into Common Areas, streets, roadways, paths, parks or other uses and (f) removing or exempting any portion of the Property and any Lots or Common Areas from the terms and provisions of this Declaration. The exercise by Developer of any of the rights reserved unto Developer in this Section 2.5 may be exercised by Developer without any requirement that the consent or approval of any Owners, the Association, the ARC or any Mortgagees be obtained.

Section 2.6 Subdivision Record Map. Developer reserves the right to record, modify, amend, revise and otherwise add to, at any time and from time to time, the Subdivision Record Map of the Property setting forth such information as Developer may deem necessary with regard to the Property, including, without limitation, the locations and dimensions of all Lots, Common Areas, Additional Property, public or private roads, utility systems, drainage systems, utility easements, drainage easements, access easements, set-back line restrictions, retention ponds and drainage basins. Any such Subdivision Record Maps or any amendments thereto shall be binding on the portions of the Property indicated thereon as if such Subdivision Record Map were specifically incorporated into this Declaration. Notwithstanding anything provided to the contrary in this Declaration, the rights reserved by Developer pursuant to this Section 2.6 may be exercised by Developer without any requirement that the consent or approval of any Owners or Mortgagees be obtained (other than the Owner or Mortgagee of any Lot which is being subdivided or re-subdivided) and shall include, without limitation, the right to (a) divide and re-subdivide, combine, subdivide and re-subdivide any Lots, Common Areas and other portions of the Property owned by Developer, and (b) amend from time to time and at any time Exhibit "A" to this Declaration to reflect any such subdivision or re-subdivision of any portion of the Property, or the addition of Additional Property.

Section 2.7 Parking. All vehicles shall be parked within the garage located on the Lot. No vehicles may be parked on the street at any time. Guests may park in the driveway of the Lot they are visiting.

ARTICLE III ORGANIZATION AND MANAGEMENT OF THE ASSOCIATION

Section 3.1 Members. All Owners shall be members of the Association.

Section 3.2 Association Insurance Requirements. The Association shall obtain and maintain at all times the following insurance:

(a) Fidelity Bonds and Directors' and Officers' Insurance covering all directors, officers and employees of the Association and all managing agents who handle Association funds;

(b) Adequate property and casualty insurance for the benefit of the Association insuring all insurable improvements, if any, located within the Common Areas against loss or damage by fire or other hazards, including, without limitation, extended coverage, flood, vandalism and malicious mischief, which coverage shall be in an amount, with such insurance carriers, at such costs and with such deductibles as the Association may determine;

(c) Public liability insurance coverage covering all of the Common Areas and any damage or injury caused by the negligence of the Association and its directors, officers, partners, agents and employees thereof, in such amounts, with such insurance carriers, at such costs and with such deductibles as the Board may determine;

(d) If applicable, worker's compensation insurance, employer's liability insurance and all other types of insurance required by law, including, without limitation, errors and omissions insurance coverage, in such amounts, with such insurance carriers, at such costs and with such deductibles as the Association may determine; and

(e) All insurance coverage authorized hereunder shall be written in the name of the Association. To the extent the same may be obtained at a nominal cost, all such policies shall contain a waiver of subrogation clause pursuant to which the insurer waives any claims against the Association, and the Owners, Occupants and the family members, servants, agents, and guests of the Owners and/or Occupants.

ARTICLE IV EASEMENTS

Section 4.1 Grant of Nonexclusive Easements to Owners: Subject to the terms and conditions of this Declaration and the Rules and Regulations from time to time established by the Association with respect to the Common Areas and Easement for Ingress and Egress, Developer does hereby grant to each Owner and Occupant the nonexclusive right, privilege, and easement of access to and the use and enjoyment of the Common Areas and for purposes of ingress and egress to the Lots, an easement for ingress and egress as shown on the Subdivision Record

Map (“Easement for Ingress and Egress”) in common with all other Owners and Occupants and their parties having a right or interest therein and their respective successors and/or assigns. Subject to the remaining terms of this Declaration, the easement and rights granted pursuant to this Section 3.1 are and shall be permanent and perpetual, are nonexclusive, are appurtenant to, and shall pass and run with title to each Lot.

Section 4.2 Utility Easements. Developer reserves for itself and the Association the right to use, dedicate and/or convey to the appropriate local authority or agency, and/or to the appropriate utility company or other companies, rights-of-way or easements on, over or under the ground to erect, maintain and use, electric and telephone poles, wires, cables, cable television, conduits, storm sewers, sanitary sewers, surface drainage, water mains and other suitable equipment for the conveyance and use of electricity, telephone equipment, gas, sewer, water, surface water drainage, cable television, or other public conveniences or utilities, on, in and over the utility easements reflected on the Subdivision Record Map or as may hereafter appear on any plat of record of the Property subject to this Declaration, together with the right to construct within such reserved easement such swales and other surface water drainage systems as Developer shall, in its sole discretion, deem necessary.

Section 4.3 Additional Easements and Uses. For so long as Developer owns any Lot, Developer, and, thereafter, the Association, on its own behalf and on behalf of all Owners, who hereby appoint Developer and/or the Association, as the case may be, irrevocably, as their attorney-in-fact for such purposes, shall have the right to grant such additional electric, telephone, water, sanitary sewer, landscaping, irrigation, security, maintenance, drainage, gas, cable television and/or other utility, recreational or service easements or facilities (subject to applicable restrictions), in any portion of the Property, and to grant access easements or relocate any existing access easements in any portion of the Property, as Developer or the Association shall deem necessary or desirable for the proper operation and maintenance of the Property, or any portion thereof, or for the general welfare of the Owners, or for the purpose of carrying out any provisions of this Declaration, provided (a) such new easements or relocation of existing easements will not, in the opinion of the Board, unreasonably interfere with any Owner’s enjoyment of the portion of the Property owned by such Owner, (b) any required work is done at the sole cost and expense of the Association, and after completing such work, the Association will restore any portion of the Property which was affected to the same or as good a condition as existed immediately before the commencement of such work, and (c) following the completion of such work, the Association shall cause a survey to be made of the easement showing its location on the Property and cause the same to be recorded in the Probate Office. In furtherance of the rights granted in this Section, Developer and/or the Association may, as it deems necessary or desirable, provide for the simultaneous or concurrent use of any presently existing or additional easements by the Owners, Occupants, and the Owner’s and Occupant’s respective tenants, employees, guests, invitees, licensees and/or agents.

Section 4.4 Reservation of General Access Easement. Developer does hereby establish and reserve for itself and its successors and assigns and does hereby grant to the Association and their respective agents, employees, representatives, invitees, successors and assigns, a permanent and perpetual non-exclusive easement appurtenant over, across, through and upon each Lot for the purposes of (a) providing ingress to and egress from each Lot for (i) inspecting each Lot and any Improvements thereon in order to determine compliance with the

provisions of this Declaration and (ii) the performance of the respective duties of Developer and the Association hereunder, including, without limitation, taking any action required or permitted to be taken by Developer, the ARC and the Association pursuant to any of the terms or provisions of this Declaration; provided, however, that upon completion and occupancy of any dwelling, then the foregoing easement shall not be deemed to allow or grant any rights to Developer, the ARC or the Association to enter onto any Lot and dwelling located thereon, except in the case of emergencies, and shall be utilized only during normal business hours and then, whenever practicable, only upon advance notice to the Owner or Occupant of such Lot directly affected thereby, and (b) painting, repairs, mowing, removing, clearing, cutting or pruning underbrush, weeds, stumps or other unsightly growth and removing trash so as to maintain reasonable standards of health, fire, safety and appearance within the Property; provided, however, that such easement shall not impose any duty or obligation upon Developer, the ARC or the Association to perform any of the foregoing actions.

Section 4.5 Reservation of Easements With Respect to Common Areas.

(a) Easement Upon Common Areas. Developer does hereby establish and reserve, for itself, the ARC, the Association, and their respective agents, employees, representatives, invitees, successors and assigns, a permanent and perpetual nonexclusive easement appurtenant over, across, under, through and upon all of the Common Areas for the purpose of (i) constructing, installing, repairing and replacing any Improvements to the Property or to the Common Areas, and (ii) doing all other things reasonably necessary and proper in connection therewith; provided, however, that nothing in this sentence shall obligate Developer to undertake any of the foregoing.

(b) Changes in Common Areas. Developer does hereby establish and reserve unto itself and its successors and assigns the permanent right to change, modify and realign the boundaries of any of the Common Areas, any Lots, or other portions of the Property or of the Development owned by Developer. Developer further reserves the right, but shall not have any obligation, to convey by quitclaim deed to the Association at any time and from time to time any portion of the Property, or any Improvements thereto to be utilized as Common Areas, as Developer, in its sole discretion, may determine.

Section 4.6 Additional Documents. All Owners shall be required to execute such other documents as are necessary or convenient to effectuate the intent of this Declaration with respect to all easements which may be created pursuant to this Article III.

Section 4.7 Limitations. Any easements which may be created pursuant to this Article III shall be appurtenant to, and the benefits and burdens thereof shall pass along with the title to, every Lot and are further subject to the following limitations:

(a) All provisions of this Declaration and the Certificate of Formation and Bylaws of the Association;

(b) All the Rules and Regulations governing the use and enjoyment of the Property which may or may have been or may hereafter be adopted by the Association;

(c) All restrictions contained on any and all plats of all or any part of the Common Areas or any other part or parts of the Property; and

(d) Developer does hereby establish and reserve for itself and its successors and assigns and does hereby grant to the Association and its agents, employees, successors and assigns, a permanent and perpetual right and easement on, over, across, through and upon all Lots and all unimproved portions of any Lots for the purpose of taking any action necessary to effect compliance with the Architectural Standards and any watershed, soil erosion or environmental rules, regulations and procedures from time to time affecting or otherwise promulgated or instituted by any Governmental Authorities or the Board. The easement and right established, reserved and granted herein shall include, without limitation, the right to implement erosion control procedures and practices, the right to drain standing water and the right to take any other action which may be required in order to satisfy the requirements of the Architectural Standards or any Governmental Authorities, including, without limitation, any watershed, soil erosion, storm water discharge or environmental rules, regulations or procedures affecting the Property. Except in the case of an emergency situation or a perceived emergency situation, the exercise by Developer or the Association of the rights reserved or granted in this Section 3.8 shall not unreasonably interfere with the use or occupancy of any Improvement.

ARTICLE V ARCHITECTURAL CONTROL

Section 5.1 Architectural Control. The Board may appoint an Architectural Review Committee (“ARC”) consisting of not less than three (3) and no more than five (5) members to review and approve plans and specifications for Improvements to be constructed on the Lots to ensure compliance with the Declaration and Architectural Standards. The members of the ARC may consist of architects, landscape designers, and other professionals and need not be made up of members of the Association. Further, the ARC shall meet as often as is necessary to review and approve the plans and specifications. A majority of the members of the ARC shall constitute a quorum of the ARC and any submitted plans must be approved by at least a majority of the members present of the ARC. If the Board of Directors does not appoint an ARC, the Board shall act as the ARC.

Section 5.2 Architectural Standards. The ARC is hereby authorized to promulgate and amend or modify from time to time the Architectural Standards, which includes, without limitation, regulations governing policies, guidelines and minimum requirements to be satisfied with respect to the construction, location, landscaping and design of all Improvements on any Lot, the content and manner in which plans and specifications and other documentation and information concerning the construction of any Improvements on a Lot are to be submitted to and approved by the ARC, and any other matters affecting the construction, alteration, repair or maintenance of any Improvements on any Lot. The Architectural Standards adopted by the ARC shall be in addition to the provisions and requirements set forth in this Declaration and shall be binding upon and enforceable against all Owners. The ARC will be responsible for review and approval of initial proposed plans for all development and improvements of the Lots and any changes thereto following the initial construction.

Section 5.3 Approval of Plans and Specifications.

(a) IN ORDER TO PRESERVE THE ARCHITECTURAL AND AESTHETIC APPEARANCE AND THE NATURAL SETTING AND BEAUTY OF THE PROPERTY, TO ESTABLISH AND PRESERVE A HARMONIOUS DESIGN FOR THE PROPERTY AND TO PROTECT AND PROMOTE THE VALUE OF THE PROPERTY, THE LOTS AND ALL IMPROVEMENTS THEREON, NO IMPROVEMENTS OF ANY NATURE SHALL BE COMMENCED, ERECTED, INSTALLED, PLACED, MOVED ONTO, ALTERED, REPLACED, RELOCATED, PERMITTED TO REMAIN ON OR MAINTAINED ON ANY LOT BY ANY OWNER, OTHER THAN DEVELOPER, WHICH AFFECT THE EXTERIOR APPEARANCE OF ANY IMPROVEMENTS ON THE LOT UNLESS PLANS AND SPECIFICATIONS THEREFOR HAVE BEEN SUBMITTED TO AND APPROVED BY THE ARC IN ACCORDANCE WITH THE TERMS AND PROVISIONS OF SECTION 4.3(b) BELOW. WITHOUT LIMITING THE FOREGOING, THE CONSTRUCTION AND INSTALLATION OF ANY FURTHER IMPROVEMENTS ON THE LOT SHALL NOT BE UNDERTAKEN, NOR SHALL ANY EXTERIOR ADDITION OR CHANGE OR ALTERATION BE MADE (INCLUDING, WITHOUT LIMITATION, PAINTING OR STAINING OF ANY EXTERIOR SURFACE) TO ANY IMPROVEMENTS, UNLESS THE PLANS AND SPECIFICATIONS FOR THE SAME HAVE BEEN SUBMITTED TO AND APPROVED BY THE ARC IN ACCORDANCE WITH THE TERMS AND PROVISIONS OF SECTION 4.3(b) BELOW.

(b) The ARC is hereby authorized and empowered to approve all plans and specifications and the construction or alteration of all Improvements on any part of the Property. Prior to the commencement of construction, repair or replacement of any Improvements on any Lot, the Owner thereof shall submit to the ARC plans and specification and related data for all such Improvements, which shall include two copies of each of the following, if applicable:

- (i) Plans and specifications;
- (ii) Color samples and specifications of all exterior materials and finishes or proposed changes to exterior materials and finishes;
- (iii) Site development plan prepared by a licensed surveyor; and
- (iv) Such other plans, specifications or other information or documentation as may be required by the rules and regulations of the ARC;

(c) The ARC shall, in its sole discretion, determine whether the plans and specifications and other data submitted by any Owner for approval are acceptable. One copy of all plans, specifications and related data so submitted to the ARC shall be retained in the records of the ARC and the other copy shall be returned to the Owner submitting the same marked “approved,” “approved as noted” or “rejected.” The ARC will charge a reasonable fee, initially in the amount of \$250.00, to be paid by each Owner who submits a request to the ARC for approval of significant construction and alteration of

Improvements to cover the expense of reviewing plans and related data and to compensate any consulting architects, landscape architects, designers, engineers, inspectors and/or attorneys retained in order to approve or reject such plans and specifications and to monitor and otherwise enforce the terms hereof. The ARC may waive or increase the fee from time to time as needed. Notwithstanding anything provided herein to the contrary, an Owner may, without the necessity or requirement that ARC approval or consent be obtained, make interior improvements or alterations within his dwelling that do not affect exterior appearance of the dwelling or other Improvements in any way.

(d) The ARC shall have the right to disapprove any plans and specifications upon any ground which is consistent with the objectives and purposes of this Declaration, including purely aesthetic considerations, any failure to comply with any of the provisions of this Declaration or the rules and regulations of the ARC, failure to provide requested information, objection to exterior design, appearance or materials, objection on the ground of incompatibility of any such proposed Improvement or alteration with the scheme of development proposed for the Property, objection to the location of any proposed Improvements on any such Lot, objection to the landscaping plan for such Lot, objection to the color scheme, finish, proportions, style of architecture, height, bulk or appropriateness of any Improvement or any other matter which, in the sole judgment of the ARC, would render the proposed Improvement inharmonious with the general plan of development contemplated for the Property. The ARC shall have the right to approve any submitted plans and specifications with conditions or stipulations by which the Owner of such Lot shall be obligated to comply and must be incorporated into the plans and specifications for such Improvements. Approval of plans and specifications by the ARC for Improvements to one particular Lot shall not be deemed an approval or otherwise obligate the ARC to approve similar plans and specifications or any of the features or elements for the Improvements for any other Lot within the Property.

(e) The ARC shall have forty-five (45) days after the physical receipt of the plans and specifications and other required materials to “approve,” “approve as noted” or “reject” the request. In the event the ARC fails to “approve,” or “approve as noted,” in writing any such proposed plans and specifications within forty-five (45) days after such plans and specifications have been submitted, then the plans and specifications so submitted will be deemed to have been disapproved.

(f) Any revisions, modifications or changes to any plans and specifications previously approved by the ARC must be approved by the ARC in the same manner specified above.

(g) If construction of any approved Improvement has not substantially commenced (by clearing and grading, pouring of footing and otherwise commencing framing and other related construction work) within one (1) year of approval by the ARC of the plans and specifications for such Improvements, then no construction may be commenced (or continued) on such Lot and the Owner of such Lot shall be required to resubmit all plans and specifications for any such Improvements to the ARC for approval in the same manner specified above.

(h) Any approval of plans and specifications by the ARC pursuant to this Section 4.3 shall not be construed in any respect as a representation or warranty of the ARC, the Developer, or the Association that such plans are in conformity with any applicable rules, regulations, and requirements of any governmental authorities or that any such plan or the dwelling based thereon is architecturally sound or meets any standards of engineering compliance or is properly designed but is rather for aesthetic concerns only. It shall be the responsibility of each Owner who submits any such plans to the ARC to satisfy himself as to such conformity with all other requirements and proper design.

(i) Before any significant construction of Improvements to be constructed on the Lot in the Property begins, a \$1,000.00 Common Area repair deposit must be paid to the Association. If the road shoulders, roads and other Common Areas have not been damaged during construction, in the sole opinion of the ARC, the deposit, or a portion thereof, will be refunded.

(j) All construction or alterations of Improvements, once begun, must be completed within a reasonable time not to exceed twelve (12) months.

Section 5.4 Construction Without Approval. If (a) any Improvements are initiated, installed, maintained, altered, replaced or relocated on any Lot without ARC approval of the plans and specifications for the same, or (b) the ARC shall determine that any approved plans and specifications for any Improvements or the approved landscaping plans for any Lot are not being complied with, then, in either event, the Owner of such Lot shall be deemed to have violated this Declaration and the ARC shall have the right to exercise any of the rights and remedies set forth in Section 4.7 below.

Section 5.5 Inspection. The ARC, the Association, or any agent, employee or representative thereof may at any reasonable time and from time to time enter upon and inspect any Lot or any Improvements being constructed thereon in order to determine whether the approved plans and specifications therefor are being complied with. Any such entry shall not be deemed to be a trespass or any other wrongful act by the ARC.

Section 5.6 Limitation of Liability. Notwithstanding anything provided herein to the contrary, neither Developer, the ARC, the Association, nor any agent, employee, representative, member, shareholder, partner, joint venturer, officer or director thereof, shall have any liability of any nature whatsoever for any damage, loss or prejudice suffered which may be claimed, paid or incurred by any Owner or any other person on account of (a) any defects in any plans and specifications submitted, reviewed or approved in accordance with the provisions of this Article IV, (b) any defects, structural or otherwise, in any work done according to such plans and specifications, (c) any failure to approve or disapprove any plans, drawings, specifications or other data submitted by any Owner for approval pursuant to the provisions of this Article IV, (d) any construction or performance of any work related to such plans, drawings and specifications, (e) any bodily injuries (including death) to any Owner, Occupant or the respective family members, guests, employees, servants, agents, invitees or licensees of any such Owner or Occupant, or any damage to any Improvements or the personal property of any Owner, Occupant or his family members, guests, employees, servants, agents, invitees or licensees of such Owner or Occupant, which may be caused by, or arise as a result of any defect, structural or otherwise, in any

Improvements or the plans and specifications therefore or any past, present or future soil and/or subsurface conditions, known or unknown (including, without limitation, underground mines, tunnels or other geological formations or conditions on or under any Lot) and (f) any other loss, claim, damage, liability or expense, including court costs and attorneys' fees, suffered, paid or incurred by any Owner or Occupant arising out of or in connection with the use and occupancy of any Lot or any Improvements situated thereon.

Section 5.7 Enforcement and Remedies. In the event any of the provisions of this Article IV are breached or are not otherwise being complied with in all respects by any Owner or Occupant or his family members, guest, invitees, agents, employees or contractors of any Owner or Occupant, then the ARC and the Association shall each have the right, but not the obligation, at their option to (a) enjoin any further construction, repair, replacement or alteration on any Lot and require the removal or correction of any work in place which does not comply with the plans and specifications approved by the ARC for such Improvements, and/or (b) through their designated agents, employees, representatives and independent contractors, enter upon such Lot and take all action necessary to extinguish such violation or breach and/or (c) levy a fine (in an amount to be determined by the Board of Directors of the Association and set forth in the Rules and Regulations) against the Owner or Occupant which fine shall constitute a lien against the Lot. All costs and expenses incurred by the ARC or the Association in enforcing any of the provisions of this Article IV, including, without limitation, attorneys' fees, court costs, costs and expenses of witnesses, engineers, architects, designers, land planners and any other persons involved in the correction of nonconforming work, the completion of uncompleted work or in any judicial proceeding, together with any other costs or expenses incurred by the ARC or the Association in causing any Owner or such Owner's contractors, agents or invitees to comply with the terms and provision of this Article IV, shall be paid by such Owner, shall constitute an individual Assessment to such Owner and, if the same is not paid when due, shall become a lien on the Lot as provided for in Article VI below and be subject to foreclosure as provided for therein. Notwithstanding anything provided herein to the contrary, the rights and remedies of the ARC and the Association set forth herein shall not be deemed exclusive of any other rights and remedies which the ARC or the Association may exercise at law or in equity or hereunder.

ARTICLE VI RESTRICTIONS

Section 6.1 Rules and Regulations of the Association. The Association is authorized to promulgate, amend and enforce Rules and Regulations concerning the operation and use of the Property; provided that such Rules and Regulations are not contrary to or inconsistent with the Covenants or Certificate of Formation. A copy of the Rules and Regulations shall be furnished by the Board of Directors to each Owner prior to the time they become effective. All present and future Owners and Occupants of the Lots and any person who uses any part of the Property in any manner, are subject to, and shall comply with the provisions of the Covenants and the Rules and Regulations. The acquisition, rental or occupancy of a Lot or the use of any part of the Property by any person shall constitute his agreement to be subject to and bound by the provisions of this Declaration and the Rules and Regulations, and such provisions shall be deemed to be enforceable as equitable servitudes and covenants running with the land and shall bind any person having at any time any interest or estate in such Lot, as though such provisions were recited and stipulated in full in each and every deed of conveyance or lease thereof. The Association may

promulgate enforcement provisions for violation of any Rule or Regulation by an Owner or Occupant, his family members, guests, invitees, lessees or renters, including the payment of fines for such violations.

Section 6.2 Restrictions on Use. The use of the Property is subject to the following restrictions:

(a) Each Lot is restricted to residential use by a Single Family Unit and the parking areas and driveways are limited to the parking of passenger automobiles. No commercial vehicle shall be parked on the Property, except to make deliveries. The garages shall be used for the parking of vehicles and storage space and shall not be used as living space.

(b) There shall be no obstruction of the Common Areas, nor shall anything be kept or stored in the Common Areas (except appropriate furniture on the patios or terraces appurtenant to any Improvement located on a Lot), nor shall anything be constructed on or planted in or removed from the Common Areas, nor shall the Common Areas in any other way be altered without the prior written consent of the Association.

(c) No immoral, improper, offensive or unlawful use shall be made of any Lot, Common Area, or any part thereof, and all laws, zoning ordinances and regulations of all Governmental Authorities having jurisdiction over the Property shall be observed.

(d) No Owner shall permit anything to be done or kept in or on his Lot or in the Common Areas which will result in any increase of fire or hazard insurance premiums or the cancellation of insurance on any part of the Property, or which would be in violation of any law.

(e) No noxious or offensive activities shall be carried on, nor shall any outside lighting or sound speakers or other sound producing devices be used, nor shall anything be done, on any part of the Property which in the judgment of the Board of Directors of the Association, may be or become an unreasonable annoyance or nuisance to the other Owners.

(f) No Owner shall cause or permit anything to be placed on the Common Areas immediately surrounding the Lot. No awning, canopy, window air conditioning unit, shutter, or other fixture shall be affixed to or placed upon the exterior walls or roof of any dwelling or Improvement on any part of the Common Areas.

(g) No satellite dishes over one (1) meter shall be allowed on the Property at any time. Satellite dishes less than one (1) meter shall not be allowed on any part of the Common Areas. Satellite dishes less than one meter may be allowed on the Lot with the express approval of the Board of Directors as to location of the receiving equipment and dish.

(h) Outside clotheslines or other outside facilities for drying or airing clothes shall be prohibited on any Lot. No clothing, rugs or other items shall be hung, placed or allowed to remain on any railing, fence or wall. No clothes, sheets, blankets, laundry of

any kind or other articles shall be hung out or exposed from or on any part of the Common Areas. The Common Areas shall be kept clear of rubbish, debris and other unsightly materials.

(i) No one shall use or permit to be brought into any Lot or upon any of the Common Areas and facilities any inflammable oils or fluids such as gasoline, kerosene, naphtha or benzene, or other explosives or articles deemed extra hazardous to life, limb or property, without the written consent of the Board of Directors of the Association.

(j) No Owner or Occupant may conduct any business, trade, garage sale, moving sale, rummage sale, tag sale or similar activity at or about the Property, whether on a Lot or otherwise unless scheduled as a planned community activity approved by the Association, except that an Owner or Occupant residing in a dwelling or other Improvement on a Lot may conduct business activities on the Lot so long as: (i) the existence or operation of the business activity is not apparent or detectable by sight, sound or smell from the Lot or from outside any dwelling or other Improvement located on the Lot; (ii) the business activity conforms to all zoning and other legal requirements for the Property; (iii) the business activity does not, in the Board's reasonable judgment, generate any vehicular or pedestrian traffic or a number of vehicles being parked in the Property; (iv) the business activity is consistent with the residential character of the Property and does not constitute a nuisance, or a hazardous or offensive use, or threaten the security or safety of other residents of the Property, as may be determined in the sole discretion of the Board. The terms "business" and "trade", as used in this provision, shall be construed to have their ordinary, generally accepted meanings and shall include, without limitation, any occupation, work, or activity undertaken on an ongoing basis which involves the provision of goods or services to persons other than the provider's family and for which the provider receives a fee, compensation, or other form of compensation.

(k) No animal or pet shall be kept for commercial purposes or be allowed to create or cause any disturbance or nuisance of any kind, and if an animal or pet does cause or create a nuisance or an unreasonable disturbance, said animal or pet shall be permanently removed from the Property within seven (7) days from the date the Owner receives written notice from the Board of Directors to remove such animal or pet. The Owner of any pet or animal shall be liable for any and all damage caused by such animal or pet to any part of the Property. Notwithstanding the foregoing, no more than two (2) domesticated pets may be kept on any Lot without the permission of the Board of Directors and no potbellied pigs, venomous snakes, or animals, including particular breeds of dogs and cats, deemed vicious or dangerous by the Board may be brought onto or kept on the Property at any time. The Board of Directors shall be entitled to adopt Rules and Regulations relating to the maintenance of pets on the Property and the Association may charge a fee or deposit for the privilege of maintaining pets on the Property.

(l) No structure of a temporary character, trailer, tent, shack, carport, garage, barn, fence or other outbuilding shall be erected by any Owner, other than the Developer, on any portion of the Property, at any time, either temporarily or permanently, without the prior written approval of the Association.

(m) The display or discharge of firearms or fireworks on the Common Areas is prohibited; provided, however, that the display of lawful firearms on the Common Areas is permitted by law enforcement officers and also is permitted for the limited purpose of transferring firearms across the Common Areas to or from an Owner's Lot so long as the firearm is not loaded and not carried in a threatening manner. The terms "firearms" includes "B-B" guns, pellet guns and other firearms of all types, regardless of size.

(n) Lot Owners and Occupants are prohibited from smoking or vaping inside a dwelling.

(o) One (1) generator per Lot may be used during power outages and shall be approved by the Architectural Review Board before being installed.

Section 6.3 Landscaping.

(a) Each Owner shall be responsible for the cost of installation, replacement and maintenance of all landscaping in the back yard of the Lot. The landscaping plan shall be submitted to the ARC for approval prior to installing or changing the plant materials. The Association shall be responsible for maintenance of all landscaping in the front and side yards of the Lots.

(b) No Owner shall allow the lawn grass on his or her Lot to grow to a height where it looks unkempt, in the sole discretion of the Association.

(c) No hedge or shrubbery planting which obstructs sight-lines of streets and roadways shall be placed or permitted to remain on any Lot. The determination of whether any such obstruction exists shall be made by the Association, whose determination shall be final, conclusive and binding on all Owners.

(d) No rocks or other substances shall be placed on any Lot as a front or side yard border. No bird baths, fountains, waterfalls, pools, ponds, reflectors, flag poles, statues, lawn sculptures, lawn furnishings, artificial plants, rock gardens, rock walls, bird houses or other fixtures and accessories shall be placed or installed within the front or side yards of any Lot, or on the rear (back) yard of any Lot if it can be seen from the street.

(e) No vegetable, herb or similar gardens or plants shall be planted or maintained in the front or side yards of any Lot or in the rear (back) yard of any Lot if the same would be visible from any street.

(f) The Association may from time to time promulgate Rules and Regulations adopting an approved list of plant life which may be utilized on any Lot, which Rules and Regulations may require that either a minimum dollar amount be established and utilized as the landscaping budget for each Lot, or that a minimum number of plantings of certain sizes, types and specifications be used on any Lot.

(g) Seasonal or holiday decorations (e.g., Christmas trees and lights, pumpkins, Easter decorations) shall be promptly removed from each Lot within fifteen (15) days after such holiday.

Section 6.4 Storm Drains. Developer has installed, or will cause to be installed, pipes, swales, headwalls, flumes, surface inlets and other structures necessary for proper control of storm drainage and runoff. Owners shall not alter, modify, or in any way interfere with the functionality of these structures. Additionally, Owners shall not allow debris, grass clippings, fences or any other items to impede the function of the drainage structure and shall maintain the same.

Section 6.5 Exterior Lighting. All exterior lighting, including, without limitation, free standing lighting and utility (e.g., flood) lights, must be of a design and in a location approved by the ARC.

Section 6.6 Exterior Materials and Finishes. No exterior materials and finishes of any Improvement on any Lot may be changed except with approval of the Association. All wood surfaces utilized on the exterior of any dwelling, including windows and doors, shall be painted or stained at all times in colors approved by the Association.

Section 6.7 Fences. No fences, including but not limited to chain link, vinyl coated, wire or above ground electric fences, shall be permitted on the Property other than those built by the Developer pursuant to the development plan.

Section 6.8 Windows, Window Treatments and Doors.

(a) Reflective glass shall not be permitted on any portion of any dwelling or Improvement. No foil or other reflective materials shall be installed on any windows or used for sun screens, blinds, shades or other purposes.

(b) The ARC may adopt guidelines for the types of windows and materials from which windows may be allowed on any dwelling. Burglar bars or doors (including wrought iron doors) are not permitted. No aluminum or metal doors with glass fronts (e.g., storm doors) shall be allowed on any dwelling or Improvement. Appropriate window treatments shall be used on all windows. Sheets, bed linens, blankets, foil and paper or plastic bags are not appropriate window treatments.

Section 6.9 Mailboxes. Mailboxes shall be maintained for the Lot as installed by the Developer. Mailboxes shall contain only the name and address of the Owner or Lot. No further inscription, paintings, ornaments or artistry shall be allowed on the mailboxes.

Section 6.10 Outdoor Furniture and Recreational Facilities.

(a) No furniture shall be placed, kept, installed, maintained or located in or on the front or side yards or areas of a Lot. Any furniture placed, kept, installed, maintained or located at the rear of or behind a dwelling shall, to the greatest extent practicable, be located so that the same shall not be visible from any street.

(b) Basketball backboards and goals are not allowed on the Lot.

(c) Barbecue grills or other types of outdoor cooking equipment and apparatus shall be located only at the rear of a dwelling and, to the extent practicable, shall not be visible from any street.

Section 6.11 Trash, Rubbish and Nuisances.

(a) No trash, garbage, rubbish or debris of any kind shall be dumped, placed or permitted to accumulate upon any portion of the Property nor shall any nuisance or odors be permitted to exist or operate upon or arise from any Lot which would render any portion thereof unsanitary, unsightly, offensive or detrimental to persons using, occupying or owning any other Lots. Noxious or offensive activities shall not be carried on in or from any Lot or in any part of the Common Areas, and each Owner and Occupant shall refrain from any act or use of a Lot which could cause disorderly, unsightly or unkempt conditions, result in the cancellation of or increase in insurance coverage or premiums for any portion of the Property or be in violation of any law, statute, ordinance, rule, regulation or requirement of any Governmental Authority. Without limiting the generality of the foregoing, no horns, whistles, bells, speakers or other sound devices, other than reasonable security and fire alarm devices used exclusively for such purposes, shall be located, used or placed upon any Lot. Any Owner or Occupant or any of the respective family members, guests, invitees, servants, agents, employees or contractors of such Owner or Occupant who dumps, places or allows trash or debris to accumulate on his or her Lot or on any other portion of the Property shall be liable to the Association for all costs incurred by the Association to remove the same.

(b) Trash, garbage and any other refuse or waste shall not be kept on any Lot except in sanitary containers or garbage compactor units. Trash cans and containers shall at all times be kept at the rear of or inside a dwelling and shall be screened from view from streets and adjacent Lots and dwellings by appropriate landscaping or fencing approved by the Association. Each Owner shall promptly deposit all trash in the appropriate receptacle provided. Owners shall not use any garbage disposal containers of the Developer for trash disposal.

(c) No outdoor burning of trash, garbage, leaves, wood, shrubbery or other materials shall be permitted on any Lot or other portion of the Property.

Section 6.12 Recreational Vehicles and Machinery and Equipment.

(a) Mobile homes, motor homes, trailers of any kind, campers, motorized carts and all-terrain vehicles, tractors, construction machinery and equipment of any nature, golf carts, boats and any other type of water craft, including boat trailers, and any other similar types of vehicles, machinery or equipment shall not be permitted, stored or allowed to remain on the Common Areas or the Lot except inside the garage. The Common Areas shall not be utilized for the parking or storage of any of the foregoing vehicles, recreational vehicles, machinery or equipment. Any bicycles, lawnmowers, tools or any other vehicles, machinery or equipment brought onto a Lot shall be stored in the garage or dwelling.

(b) Any vehicle which is inoperable shall be immediately removed from the Property. No Owner or Occupant shall repair or restore any vehicle, machinery or equipment of any kind upon or within any Lot or on any portion of the Common Areas, except for emergency repairs and then only to the extent necessary to enable the immediate movement thereof to a proper repair facility located outside of the Property.

Section 6.13 Signage. A maximum of two (2) signs, in size and color to be approved by the ARC, may be posted on a Lot upon a single sign slab approved by the ARC, at a height not to exceed five (5) feet from the ground level advertising the Lot for sale, or during the construction of the dwelling, containing information identifying the builder of such dwelling. No other signage, banners, flags, or advertising posters shall be allowed without obtaining ARC approval. The location of such signage shall be established by the ARC but in no event shall any signage authorized by this Section or which may be approved by the ARC be attached, nailed or otherwise adhered to any tree or other plant life on a Lot.

Section 6.14 Construction of Improvements.

(a) During the construction of any Improvements, (i) all Lots subject to such construction shall be maintained in a clean condition, free of debris and waste material, (ii) all unused construction materials shall be stored, to the extent practicable, out of view from any street, (iii) all construction trash, debris and rubbish on each Lot shall be properly disposed of outside the Property immediately, and (iv) any temporary or portable toilet will be placed out of view from any street.

(b) During the construction of any Improvements, care should be taken that construction equipment and the vehicles of all contractors, subcontractors, laborers, materialmen and suppliers do not interfere with the use of the Common Area parking for the Owners and Occupants.

(c) Any Improvements made to the Lot shall be constructed in compliance with any rules established by the Association, all applicable federal, state, county and local laws, ordinances, rules, regulations, and zoning and building code requirements. Each Owner shall be solely responsible for obtaining from the appropriate Governmental Authorities all necessary permits and licenses and otherwise paying all required fees for the construction of any Improvements on such Owner's Lot. Each Owner shall also be responsible for strict compliance with any rules established by the Association and all governmental requirements, both during and after completion of construction of any Improvements on such Owner's Lot.

(d) When any Owner submits to the ARC plans and specifications for construction of Improvements in accordance with Article IV above, the name of the building contractor selected by such Owner for construction of such Improvement shall also then be submitted to the ARC; however, if the identity of the building contractor is not known at that time, then the name of the building contractor will be submitted when determined prior to construction. The ARC shall have the right, in its sole discretion, to approve or disapprove of any building contractor so selected by such Owner. Each building contractor approved by the ARC in accordance with this Section 5.14(d) will be required

to remit to the ARC a refundable damage/clean up deposit (the “Deposit”) in an amount established by the ARC or the ARC. Should such building contractor damage or fail to properly clean up the Property or Common Areas as required herein, or any supplemental rules or regulations promulgated by the ARC, the ARC may, in its sole discretion, initiate appropriate action to remediate any such condition at such building contractor’s expense. The cost of any such remediation shall be deducted from the Deposit and any amount expended by the ARC in excess of the Deposit in remediating such condition shall be billed to such building contractor. Within thirty (30) days of the completion of any improvement, the ARC shall refund to such building contractor any unexpended portion of the deposit.

Section 6.15 Swimming Pools. Outdoor hot tubs, reflecting ponds, saunas, whirlpools, or lap pools shall not be constructed, installed or maintained on any Lot.

Section 6.16 Traffic Regulations. The Association shall be entitled to make and enforce any traffic Rules and Regulations it deems appropriate, including the right to levy fines for the violation thereof. In the event of any conflict between the provisions of the laws of the State of Alabama and the traffic Rules and Regulations promulgated by the Association, the more restrictive shall govern.

Section 6.17 Lease of Lots. Entire Lots or any dwelling thereon may be leased by the Owners; provided, however, that any such lease and the rights of any tenant thereunder are hereby made expressly subject to the power of the Association to prescribe reasonable Rules and Regulations relating to the lease and rental of Lots or any dwelling and to enforce the same directly against such tenant or other Occupant by the exercise of such remedies as the Board deems appropriate; provided, however, that no restrictions shall be imposed which shall have the individual or cumulative effect of prohibiting or materially impairing the rental or lease of Lots or any dwelling. No individual rooms may be rented. Further, all leases must be in writing, with a copy provided to the Association upon request by the Association. This restriction on use shall be a covenant running with each Lot, creating a burden on each single Lot and Owner for the benefit of every other Lot and Owner. No lease shall be for less than six (6) months and no more than one (1) Single Family Unit per Lot or two (2) people per bedroom of any dwelling on a Lot shall occupy a Lot. Notwithstanding anything contained in this Section to the contrary, each Owner shall be responsible for the actions of his tenants and the Occupants and nothing herein or in any such lease shall relieve an Owner of his obligations under the Covenants. The provisions of this Section shall not be applicable to the Developer who is irrevocably empowered without any limitation at all times, whether for permanent or temporary occupancy to sell, lease or rent Lots, or any dwelling or other Improvement thereon, for any period and under any terms to any lessees or purchasers or transferees with the right to take any action necessary to consummate the sale or rental of said Lots, including, but not limited to, the right to maintain model Lots with any Improvements thereon, post signs, have employees in the offices maintained on the Property, use the Common Areas and show Lots and any Improvements thereon to prospective tenants or purchasers. Sales and rental office signs and all items pertaining to the rental or sale of Lots shall not be considered Common Areas and shall remain the property of the Developer.

Section 6.18 Right of Access. Each Owner or Occupant grants a right of access to his Lot to the Association, and any other person authorized by the Association for the purpose of making inspections and for the purpose of correcting any condition originating on his Lot and

threatening other Lots, Common Areas, or for the purpose of performing installations, alterations or repairs to the mechanical or electrical services or other Common Areas within his Lot, if any, or to correct any condition which violates the provisions of any Mortgage covering another Lot, or to enforce any provision of the Covenants, provided that requests for entry are made in advance and that such entry is at a time reasonably convenient to the Owner or Occupant. In case of an emergency, such right of entry shall be immediate whether the Owner is present at the time or not. Each Owner further grants a right of access to his Lot to the Developer or his agent, or other authorized representative who is not Developer's agent, for the purpose of making all repairs required by any warranty delivered to the Owner at the closing of his Lot. To the extent that damages inflicted on the Common Areas or any Lot through which access is taken, the Owner or the Association, if it caused the same, shall be liable for the prompt repair thereof.

Section 6.19 Limitation of Liability. The Association shall not be liable for any failure of water or power supply, telephone, security, fire protection or other service to be obtained by the Association or paid for out of the Common Expense funds, for problems resulting from the operation or lack of operation of sewer lines servicing the Property, or for injury or damage to a person or property caused by the natural elements or resulting from electricity, water, snow or ice which may leak or flow from any portion of the Common Areas or from any wire, pipe, drain, conduit, appliance or equipment, however, this provision does not relieve the Association from maintenance responsibility or for damage to the Lots arising from or related to water intrusion from the Common Areas on account of maintenance or lack thereof. The Association shall not be liable to the Owner of any Lot for loss or damage, by theft or otherwise, of articles which may be stored upon any of the Common Areas. No diminution or abatement of the Common Expense assessments, as herein elsewhere provided, shall be claimed or allowed for inconvenience or discomfort arising from the making of repairs or improvements to the Common Areas or to any Lot, or from any action taken by the Association to comply with any law or ordinance or with the order or directive of any municipal or other Governmental Authority or judicial authority or for the dispossession of the Owner by reason of fire or other casualty, except to the extent covered by insurance.

Section 6.20 Enforcement. If a determination is made by the ARC or Board that any of the restrictions in this Article V or the Architectural Standards are being or have been violated upon any Lot, then the ARC shall so notify the Owner in writing, specifying the violation. If within fifteen (15) days from such notification, the ARC shall make a second determination that sufficient progress has not been made to remedy the violation, the ARC may itself, direct such actions to be taken as shall be necessary or appropriate to remedy such violation, including, without limitation, those remedies set forth in Section 4.7 herein. The Owner shall be liable for the cost and expense of all such actions, including legal fees, and the ARC may treat all such costs and expenses therefor as a charge which shall become a lien against the Lot. The Association, any Lot owner, and/or the ARC may initiate a proceeding at law or in equity to enforce the restrictions set forth in this Article V, or the Architectural Standards and/or to seek damages as incurred as a result of any breach or violation of the same.

Section 6.21 Failure of the Association to Insist on Strict Performance; No Waiver. Failure of the Association to insist in any one or more instances upon the strict performance of any provision of the Covenants, or to exercise any right or option herein contained, or to serve any notice or to institute any action shall not be construed as a waiver or a

relinquishment from the future performance of such term, covenant, condition or restriction, but such term, covenant, condition or restriction shall remain in full force and effect. The receipt by the Association of any assessment from an Owner with knowledge of the breach of any covenant hereof shall not be deemed to be a waiver of such breach and no waiver by the Association of any provision hereof shall be deemed to have been made unless expressed in writing and signed by the Board of Directors of the Association.

Section 6.22 Use by Developer. Subject to the rights of the Mortgagees hereunder, neither the Owners nor the Board of Directors of the Association nor their use of the Property or application of these Covenants shall interfere with completion of Improvements, sales of the Lots, construction of Improvements or development of the Property by the Developer. Subject to the rights of the Mortgagees hereunder, the Developer may make such use of the unsold Lots and the Common Areas as may facilitate such completion and sale, including, but not limited to, maintenance of a sales office, management office and model units, the showing of the Property and the Lots therein, the display of signs, balloons, banners and marketing materials thereon and therein and the holding of sales and promotional activities thereon. These rights exist so long as Developer holds any Lot in the Property for sale in the ordinary course of business. The Developer expressly reserves the right to lease any Lot which it may own in the Property on such terms as it may deem proper and desirable and may transfer Lots subject to such lease.

Section 6.23 Common Areas. The Developer shall convey to the Association, the title to the Common Areas as shown on the Subdivision Record Map for the benefit and use of the Owners. The Association shall assess the Common Areas in the name of the Association for tax purposes, improve and maintain the Common Areas and obtain and maintain liability insurance coverage on the Common Areas in the name of the Association.

Section 6.24 Compliance with Governmental Regulations. Each Owner and Occupant shall at all times comply with all applicable laws, ordinances, statutes, rules, regulations, requirements and code provisions of the Governmental Authorities.

Section 6.25 Additional Regulations. In addition to the restrictions set forth in these Covenants, the (i) Association shall have the right, in its sole discretion, from time to time and at any time to adopt, modify and amend the Rules and Regulations in order to impose such other, further or different requirements or restrictions which shall be binding on all Owners and Lots, including the adoption of additional or different requirements or restrictions which shall be binding on all Owners and Lots, including the adoption of additional or more specific requirements and restrictions governing the improvement and use of any Lot, and (ii) the Association shall have the right from time to time and at any time to adopt, modify and amend such Rules and Regulations as the Association, in its sole discretion, determines to be in the best interests of all Owners, which Rules and Regulations shall be binding on all Owners and Lots.

ARTICLE VII COVENANT FOR ASSESSMENTS

Section 7.1 Affirmative Covenant to Pay Assessments. Each Owner, by acceptance of a deed for a Lot, whether or not it should be so expressed in such deed, shall be obligated and hereby covenants and agrees to pay to the Association (or to an independent entity

or agency which may be designated by the Association to receive such monies), in the manner set forth herein: (i) Annual Assessments or charges levied each year by the Association, (ii) Special Assessments for capital improvements, such Assessments to be established and collected as hereinafter provided, and (iii) Individual Assessments which may be levied against any Lot and the Owner thereof as a result of such Owner's or Occupant's failure to comply with the terms of this Declaration, the Rules and Regulations adopted by the Board, or as a result of damage caused by an Owner or Occupant. Notwithstanding the foregoing, Lots owned by Developer, shall not be subject to any Assessment by the Association. The Annual Assessments, Special Assessments and Individual Assessments, together with interest, late charges, costs and reasonable attorneys' fees, shall also be a charge on each Lot and shall be a continuing lien upon each Lot against which such Assessment is made, which lien may be enforced in the manner hereinafter provided. Each such Assessment, together with interest, late charges, costs and reasonable attorneys' fees shall also be the personal obligation of the person who was the Owner of such Lot at the time when the Assessment fell due or was due.

Section 7.2 Purpose of Assessments. The Assessments levied by the Association shall be used exclusively for the preservation of the appearance, value and amenities of the Property, and in particular for the improvement, preservation, maintenance and administration of the Common Areas (including, without limitation, the payment of Common Expenses under Article VII below) and of any easement in favor of the Association and/or the Owners/Occupants, as well as for such other purposes as are properly undertaken by the Association. No profit, gain, or other benefit is to be derived by the Association from the Assessments, but, instead, such funds shall be expended only as agent for the Owners, and no part of the net earnings of the Association shall inure (other than by acquiring, constructing or providing management, maintenance, and care of the Common Areas) to the benefit of any individual.

Section 7.3 Individual Assessment. Any expenses incurred by the Association in enforcing any of the provisions of this Declaration against any specific Owner or Occupant shall be deemed an Individual Assessment against such Owner and the respective Lot owned by such Owner. Any expenses incurred by the Association as a result of damage caused by an Owner or Occupant shall be levied against the Owner and his Lot as an Individual Assessment. Such Individual Assessment shall be levied by the Association and shall be specified in a notice to the Owner, which notice shall also specify the due date for payment of the same.

Section 7.4 Annual Assessments. The Association shall levy Annual Assessments in such amounts as are necessary to meet the Common Expenses (as defined in Article VII below) and such other recurring or projected expenses as the Board of Directors of the Association may deem appropriate. The Annual Assessment for the Subdivision shall commence on January 1 of each year, and shall be paid in advance.

Section 7.5 Special Assessments. In addition to the Annual Assessments specified in Section 6.4 above, the Association may levy, at any time, one or more Special Assessments for the purpose of defraying, in whole or in part the cost of any construction, reconstruction, repair or replacement of a capital improvement upon the Common Areas, provided that any such Assessment must have the assent and approval of (a) at least fifty-one percent (51%) of the Owners who are voting in person or by proxy at a meeting duly called for this purpose, and (b) to the extent Developer is the Owner of any Lot in the Subdivision, the approval of Developer.

Section 7.6 Special Meeting. Written notice of any meeting called for the purpose of taking any action authorized under Section 6.5 above shall be sent to all Owners not less than fourteen (14) days but no more than sixty (60) days in advance of the meeting. At the first such meeting called, the presence of Owners, either in person or by proxy, entitled to cast fifty-one percent (51%) or more of all votes in the Association shall constitute a quorum. If the required quorum is not present, another meeting may be called subject to the same notice requirements and the required quorum at the subsequent meeting shall be one-half of the required quorum at the preceding meeting.

Section 7.7 Amount of Assessments. Both Annual and Special Assessments must be fixed at a uniform rate for all Lots within the Subdivision, and shall commence upon the closing of the sale of the Lot from the Developer to a third party purchaser, and shall be due and payable in such manner as established by the Board of Directors of the Association. The Board of Directors of the Association shall fix the amount of the Annual Assessment against each Lot at least thirty days in advance of each Annual Assessment period. Written notice of the Annual Assessment shall be sent to every Owner. The due date for the payment of Annual Assessments shall be established by the Board of Directors in such notice (but such due date shall be, at a minimum, thirty (30) days from the date of such notice).

Section 7.8 Certificate. The Association shall, upon written demand by Owner or Mortgagee and for a reasonable charge, furnish a certificate signed by an officer or agent of the Association setting forth whether the assessments levied against the Lot have been paid. A properly executed certification of the Association as the status of the Assessment on a Lot is binding upon the Association as of the date of its issuance.

Section 7.9 Effect of Non-Payment of Assessments; Liens; Remedies.

(a) The obligation to pay any assessment (whether Annual, Special or Individual) or installment thereof due the Association shall be in default if such assessment or any installment thereof is not paid to the Association on or before the due date for such payment. When in default, the delinquent assessment or delinquent installment due the Association shall bear interest at the rate established by the Board not to exceed the maximum legal rate on judgments allowed by law or eighteen percent (18%) until such delinquent assessment or installment and all interest due thereon has been paid in full. The Association shall have a lien against Lot for delinquent assessments. Said lien shall secure and does secure the monies due for all assessments then or thereafter levied against the Lot, and such lien shall also secure interest, if any, which may be due on the amount of any delinquent assessment owing the Association. Said lien shall also secure all costs and expenses, including late penalties and reasonable attorneys' fees incurred by the Association in collecting delinquent assessments and enforcing the lien upon said Lot. The lien granted to the Association may be foreclosed in the same manner as real estate mortgages in the State of Alabama, but the Association shall give reasonable advance notice of its proposed action to the Owner, the Mortgagee and all other lienholders of record of the Lot.

(b) The lien herein granted to the Association may be foreclosed by the Association, or its successors or assign, (the "Foreclosing Party") in the same manner as

real estate mortgages in the State of Alabama, and the Foreclosing Party, or its agent, may sell the Lot at a public sale before the door of the courthouse of the county or counties, as may be required, in which the Lot or any part of thereof is situated, after having first given notice of the time, place and terms of sale at least once a week for three (3) successive weeks preceding the date of such sale in some newspaper published in said county or counties, and after having given reasonable advance notice of the foreclosure sale to the Owner, any Mortgagee, and all other lienholders of record of the Lot. At any such sale, the Foreclosing Party may execute and deliver to the purchaser a deed and conveyance of the Lot. In the event of any sale under this Declaration by virtue of the exercise of the powers herein granted, or pursuant to any order in any judicial proceedings or otherwise, the Lot may be sold as an entirety and the Foreclosing Party in its sole discretion may elect to sell the personal property covered by this Declaration at one or more separate sales in any manner permitted by the Uniform Commercial Code of the state of Alabama, and one or more exercises of the powers herein granted shall not extinguish or exhaust such powers. If the lien granted herein is now or hereafter further secured by any chattel mortgages, pledges, contracts of guaranty, assignments of lease or other security instruments, then Foreclosing Party at its option may exhaust the remedies granted under any of said security instruments or this Declaration either concurrently or independently, and in such order as Foreclosing Party may determine. Said sale may be adjourned by Foreclosing Party, or its agent, and reset at a later date without additional publication; provided that an announcement to that effect be made at the scheduled place of sale at the time and on the date the sale is originally set. In the event of any sale of the Lot as authorized by this Section, all prerequisites of such sale shall be presumed to have been performed, and in any conveyance given hereunder all statements of facts, or other recitals therein made, as to the nonpayment or nonperformance by the Owner or as to the advertisement of sale, or the time, place and manner of sale, or as to any other fact or thing, shall be taken in all courts of law or equity as prima facie evidence that the facts so stated or recited are true. Additionally, any foreclosure sale or sale of all or any portion of the Lot under the power herein granted, Foreclosing Party may credit bid for and purchase the Lot if the highest bidder therefor, but all proceeds of such sale shall be applied: (a) first, to the expenses of such sale and of all proceedings in connection therewith, including fees and expenses of Foreclosing Party's attorneys; (b) then to the repayment of the lien granted herein; and (c) finally the remainder, if any, shall be paid to such parties as are legally entitled to it, after deducting any expenses incurred in ascertaining the identity of such parties, or as may otherwise be provided by law.

Section 7.10 Damages. In addition to the rights and remedies set forth above, if any Owner or Occupant (or any Owner's or Occupant's contractor, family members, guests or invitees) shall violate or attempt to violate any of the covenants and restrictions set forth herein, then Developer, the Association, the ARC, or any Owner, jointly and severally, shall each have the right to prosecute proceedings at law for the recovery of damages against such Owner as a result of such violations and/or maintain a proceeding in equity against such Owner to enjoin such violation; provided, however, that the rights and remedies set forth herein shall be deemed to be cumulative of all other rights and remedies available at law or in equity. In any such proceedings, Developer, the Association, the ARC or any Owner, jointly and severally, shall be entitled to recover all costs and expenses, including reasonable attorneys' fees, incurred by any of them in such proceedings, as well as interest on all unpaid amounts as specified in Section 6.9 above. The

failure of Developer, the Association, the ARC or any Owner to institute proceedings for any one (1) or more violations of this Declaration shall not constitute approval of the same or be construed as a waiver of any right of action contained herein for past or future violations of said Declaration.

Section 7.11 Exempt Property. The Board shall have the right to exempt any portion of the Property from the Assessment and liens created herein provided that such part of the Property exempted is used (and as long as it is used) for any of the following purposes:

- (a) As an easement or other interest therein dedicated and accepted by the local public authority and devoted to public use; or
- (b) As a Common Area.

ARTICLE VIII MAINTENANCE RESPONSIBILITIES

Section 8.1 Responsibilities of Owners -Maintenance.

(a) Unless specifically identified herein as being the responsibility of the Association, the maintenance and repair of all Improvements situated on the Lots or therein shall be the responsibility of the Owner of such Lot. Each Owner shall be responsible for maintaining his, her or its Lot, as the case may be, in a neat, clean and sanitary condition, both inside and outside of any dwellings or Improvements thereto.

(b) Each Owner agrees as follows:

(i) To perform all maintenance, repairs and replacements which are his obligations under subparagraph (a) of this Section 7.1;

(ii) To pay all utilities as herein provided and all taxes levied against his Lot;

(iii) Not to make any addition or alteration to the Lot or any dwelling or other Improvement thereon or to the Common Areas or to do any act that would impair the structural soundness, safety or overall design and aesthetics scheme of any part of the Property or that would impair any easement or right of an Owner without the prior written consent of the Board or ARC as provided in Article V of these Covenants;

(iv) Not to make any alteration, addition, improvement, decoration, repair, replacement or change to the Common Areas, or to any outside or exterior portion of the any Improvement located on a Lot, excluding any alteration or additions made pursuant to the procedure described in subparagraph (iv) above and including, but not limited to, altering in any way exterior doors and windows, affixing outshutters to windows or painting any part of the exterior part of such Improvement, without the prior written consent of the Association as provided in Article V of these Covenants; and

(v) To promptly report to the Association any defects or needed repairs for which the Association is responsible.

Section 8.2 Responsibilities of Owners - Utilities. Each Owner shall be required to pay all charges for utilities serving that Lot, including but not limited to electricity, water, gas, cable television, and telephone service, used or consumed in or on the Lot or any Improvement thereon. The utilities serving the Common Areas only shall be separately metered and paid by the Association as a Common Expense. The Association shall have authority, however, with regard to any utility, to use a common meter, pay the cost of such utilities used or consumed in the Lots, and have the costs thereof apportioned among the Lots based upon the Common Expense liability, use of the utility, or any other formula the Association may deem appropriate.

Section 8.3 Responsibilities of Association – Maintenance. The Association shall, in the discretion of the Board, without any approval of the Members being required:

(a) Maintain, install, reinstall, construct and repair all of the Improvements within the Common Areas, to include maintenance of all storm water detention facilities, and to maintain, repair and operate any other easement area shown on the Subdivision Record Map which is not under the control or management of a public utility or governmental authority;

(b) Maintain, install and replace all landscaping located within the Common Areas;

(c) Maintain and manage the Common Areas shown on the Subdivision Record Map so as to preserve the Common Areas in their improved state and prevent any unlawful or obnoxious activity, or other activity prohibited by this Declaration to be conducted thereon;

(d) Do all such other acts which the Board deems necessary to preserve and protect the Property and the beauty thereof, in accordance with the general purposes specified in this Declaration;

Section 8.4 Responsibilities of Association - Common Expenses. The following expenses are hereby declared to be Common Expenses which the Association is obligated to collect by Assessment and which Owners are obligated to pay as provided in Article VI hereof; provided, however, that the enumeration below of these expenses shall in no way limit the Association from considering other expenses incurred in managing the Association or any part of the Common Areas and/or the Property as expenses subject to collection by assessment:

(a) Maintenance and Repair of Common Areas: The cost and expense to keep and maintain the Common Areas in good repair and in a clean and attractive condition, if any, including the charges in Section 7.5 of this Declaration, as well as the following charges:

(i) Any electrical costs to run all common lighting and any other electrical device necessary to the Common Areas, including street lighting;

- (ii) Sanitary sewer and storm sewer lines within private drives, if applicable;
- (iii) Gas bills of the Association, if any;
- (iv) Water bills and sprinkler systems for use on the Common Areas;
- (v) Any insurance for the Common Areas;
- (vi) Any management fees, accounting fees, and legal expenses incurred by the Association;
- (vii) Maintenance costs of all detention ponds and storm water drainage areas, if applicable; and
- (viii) Such other matters which involve the use of the Common Areas as determined by the Association.

(b) Management. The cost and expense of such (i) employees or agents, including professional management agents, accountants and attorneys, and (ii) materials, supplies and equipment as may be needed to provide for the management, supervision and maintenance of the Common Areas.

(c) Property Taxes. All ad valorem taxes and other Assessments levied on the Common Areas, if any.

(d) Insurance. All premiums for insurance obtained by the Association and any deductibles required to be paid by the Association.

Section 8.5 Reserves. The Association may establish reserves for the payment of Common Expenses in the future.

Section 8.6 Interested Transactions. The Association may obtain materials and/or services from Developer and/or any of its Affiliates and/or any Members in connection with the management of the Association or any part of the Common Areas as herein contemplated; provided that the compensation for such materials and/or services is, in the opinion of the Association, comparable with the compensation of any non-affiliated third party providing similar materials and/or services which can be reasonably made available to the Association.

ARTICLE IX ENFORCEMENT OF PROTECTIVE COVENANTS, DEFAULTS AND REMEDIES

Section 9.1 Covenants Running with the Land. The easements, covenants, and restrictions set forth in this Declaration shall run with the Property and inure to the benefit of and be enforceable by Developer, its designated successors and assigns, the Association, or by any Owner and its respective heirs, successors and assigns, for a term of fifty (50) years from the date this Declaration is recorded, after which time the said protective covenants provided for herein shall automatically be extended for successive periods of ten (10) years, unless an agreement which

has been signed by Owners who own two-thirds or more of the then existing Lots of the Property, agreeing to terminate or modify this Declaration, has been recorded in the Probate Office.

Section 9.2 Remedies for Default. The existence of any breach or default hereunder by any person or entity subject to the terms, conditions, covenants and restrictions of this Declaration shall give Developer, its successors or assigns, any Owner, and/or their respective heirs, successors and assigns, and the Association, in addition to all other remedies specified therein, the right to proceed at law or in equity to compel compliance with the terms of this Declaration and to prevent the violation or breach of any of them; provided, this Declaration shall be recorded for the benefit of Developer, the ARC, the Association, the Owners and their respective Mortgagees, and the Occupants, and by such recording, no other adjoining property owner or third party shall have any right, title or interest whatsoever in the Property or its operation and continuation, in the enforcement of any of the provisions of this Declaration or the right to consent to or approve any amendment or modification to this Declaration.

Section 9.3 Nature of Remedies: Waiver. All rights, remedies and privileges granted to Developer, the ARC, the Association, the Owners, their respective heirs, successors and assigns, and the Occupants pursuant to the provisions of this Declaration shall be deemed to be cumulative, and the exercise of any one or more of them shall not be deemed to constitute an election of remedies, nor shall it preclude the party exercising the same, or any other party, from pursuing such other and/or additional rights, remedies or privileges as may be available to such party at law or in equity. The failure at any point in time to enforce any covenant or restriction shall in no event be deemed a waiver of the right thereafter to enforce any such covenant or restriction.

Section 9.4 Attorneys' Fees and Costs. All fees, costs and expenses, including attorneys' fees through all appellate levels, in connection with the Association's duty to enforce all of the protective covenants and other terms contained in or imposed by this Declaration, and all Rules and Regulations adopted pursuant to the Certificate of Formation, by the Bylaws or this Declaration may be assessed against the Owner in violation of this Declaration.

Section 9.5 No Reverter. No restriction or provision herein is intended to be, or shall be construed as, a condition subsequent or as creating any possibility of a reverter

ARTICLE X AMENDMENT OF DECLARATION

Section 10.1 Amendment by Association. During the Developer Control Period, this Declaration may be amended by Developer in Developer's sole discretion. Following the expiration of the Developer Control Period, an amendment to this Declaration may be proposed by the Board of Directors or by written instrument signed by the Owners of not less than one-fourth (1/4) of the Lots within the Property. Such proposed amendment or amendments shall be considered at a meeting of the Owners after written or printed notice of such meeting, stating the time and place thereof, and providing information regarding the proposed amendment or amendments in reasonably detailed form, shall be mailed to the Owners not less than ten days nor more than thirty days, before the date set for such meeting. If mailed, such notice shall be deemed to be properly given when deposited in the United States mail, addressed to each Owner at the

street address of its Lot, the postage thereon being prepaid. Any Owner may, by written waiver of notice signed by such Owner, waive such notice, and such waiver whether before or after the holding of the meeting, shall be deemed equivalent to the giving of such notice to such Owner. At such meeting, the amendment or amendments proposed must be approved by the affirmative vote of Owners who own not less than two-thirds (2/3) of the total Lots of the Property in order for such amendment or amendments to become effective. Thereupon, such amendment or amendments to the Declaration shall be transcribed and certified by the Board as having been duly adopted and the original or executed copy of such amendment or amendments so certified and executed with the same formalities as a deed shall be recorded in the Probate Office, within twenty days from the date on which the same became effective, such amendment or amendments to specifically refer to the recording identifying this Declaration. At any meeting held to consider such amendment or amendments, the written vote of any Owner shall be recognized if such Owner is not in attendance in person or by proxy at such meeting, provided such written vote is delivered to the Board at or prior to such meeting.

Section 10.2 Scrivener's Error. Notwithstanding the foregoing amendment provisions, any scrivener's error omission may be corrected by the filing of any amendment to this Declaration consented to by Developer and any Owners or Mortgagees of record directly affected by the amendment. No other Owner is required to consent to any such amendment. If there appears to be any other omissions or errors in this Declaration, scrivener's or otherwise, and such error or omission does not materially adversely affect the rights and interests of any other party, then such error or omission may be corrected by the filing of an amendment of this Declaration executed by Developer or the Association without the consent of any other party.

ARTICLE XI PERIOD OF DEVELOPER CONTROL

Section 11.1 Developer Control.

(a) Notwithstanding any provision contained herein to the contrary, until such time as Developer has sold and no longer retains ownership of any of the Lots within the Subdivision, or until the Developer elects to terminate its control of the Association, whichever is earlier (such period of time being referred to herein as the "Developer Control Period"), the Developer shall have the exclusive right to appoint and remove the members of the Board of Directors of the Association and the members of the ARC (who need not be Owners) and the right to amend the this Declaration, the Certificate of Formation, and the Bylaws of the Association.

(b) Notwithstanding the provisions of Section 11.1(a) above, no Assessments shall be imposed by the Association against the Developer as the Owner of an unsold Lot until the construction of the dwelling and other Improvements upon the Lot is completed.

(c) Developer may terminate its right to appoint the members of the Board of Directors and its other rights and obligations set forth herein, or any portion thereof, by relinquishing control of the Association in writing to the Owners at any time prior to the expiration of said Developer Control Period.

ARTICLE XII GENERAL PROVISIONS

Section 12.1 Deeds Subject to Covenant. Each deed for the sale of a Lot in the Subdivision will be subject to the terms and conditions of this Declaration regardless whether the deed contains a reference to this Declaration.

Section 12.2 Obligation of Owner to Build or Restore. In the event an Improvement on any Lot within the Property is damaged or destroyed in whole or in part, the Owner shall be obligated to repair or replace said structure within a reasonable time not to exceed one (1) year from the date of such damage or destruction and such repair or replacement of such structure shall be in accordance with the covenants and restrictions set forth in this Declaration. Further, all debris resulting from such damage or destruction must be removed and the Lot restored to a slightly condition with reasonable promptness, but not later than ninety (90) days after such damage or destruction.

Section 12.3 No Trespass. Whenever the Association, Developer, the ARC and their respective agents, employees, representatives, successors and assigns, are permitted by this Declaration to enter upon or correct, repair, clean, maintain or preserve or do any other action within any portion of a Lot or dwelling, the entering thereon and the taking of such action shall not be deemed a trespass.

Section 12.4 Notices. Any notice required to be sent to any Owner under the provisions of this Declaration shall be deemed to have been properly sent when mailed by United States mail, postage prepaid, return receipt requested, to the street address of the Lot owned by such Owner or at such other address designated by Owner in writing to the Board, except for meeting notices as provided in the Bylaws.

Section 12.5 Severability. Invalidation of any provision or provisions hereof by judgment or court order shall in no way affect any other provisions, all of which shall remain in full force and effect.

Section 12.6 Governing Law. Should any dispute or litigation arise between any of the parties whose rights or duties are affected or determined by this Declaration as the same may be amended from time to time, said dispute or litigation shall be governed by the laws of the State of Alabama.

Section 12.7 Captions. The captions and titles of the various articles and Sections in this Declaration are for convenience of reference only, and in no way define, limit or describe the scope or intent of this Declaration.

Section 12.8 Usage. Whenever used herein the singular shall include the plural and the singular, and the use of any gender shall include all genders.

Section 12.9 Conflict. If any irreconcilable conflict shall exist, or hereafter arise, with respect to the interpretation of any provisions of this Declaration, and any covenant of a Lot, then the provisions of this Declaration shall prevail.

Section 12.10 Effective Date. This Declaration shall become effective upon its recordation in the Probate Office.

[REMAINDER OF PAGE INTENTIONALLY LEFT BLANK]

IN WITNESS WHEREOF, Developer has caused this Declaration to be executed on the ____ day of _____ 2022.

DEVELOPER:

[_____],
an Alabama limited liability company

BY: _____

Print Name: _____

Its: _____

STATE OF ALABAMA)

COUNTY OF JEFFERSON)

I, _____, a Notary Public in and for said County, in said State, hereby certify that _____ whose name as _____ of _____, an Alabama limited liability company, is signed to the foregoing instrument, and who is known to me, acknowledged before me on this day that being informed of the contents of said instrument, he/she, in such capacity and with full authority, executed the same voluntarily for and as the act of said company, acting in his capacity as aforesaid.

GIVEN UNDER MY HAND AND SEAL OF OFFICE this, the __ day of _____, 2022.

Notary Public

[SEAL]

My Commission Expires: _____

The undersigned, as **MORTGAGEE** under the Mortgage encumbering the real property identified in the foregoing Declaration of Covenants, Conditions and Restrictions of [XYZ] Subdivision, joins in the execution of the foregoing Declaration of Covenants, Conditions and Restrictions of [XYZ] Subdivision for the purposes of i) consenting to the filing of the Declaration of Covenants, Conditions and Restrictions of [XYZ Subdivision] and ii) subordinating its Mortgage thereto.

MORTGAGEE:

[_____] a [_____] corporation

By: _____

Name: _____

Its _____

STATE OF ALABAMA)

COUNTY OF JEFFERSON)

I, the undersigned, a Notary Public in and for said County in said State, hereby certify that _____, whose name as _____ of _____, a _____ corporation is signed to the foregoing Declaration of Covenants, Conditions and Restrictions, and who is known to me, acknowledged before me on this day that, being informed of the contents of the Declaration of Covenants, Conditions and Restrictions, he/she, as such officer, and with full authority, executed the same voluntarily for and as the act of said corporation on the day the same bears date.

Given under my hand and seal of office this _____ day of _____, 2022.

Notary Public

[NOTARIAL SEAL]

My commission expires: _____

EXHIBITS

- Exhibit "A" Legal Description of Property
- Exhibit "B" Bylaws of [XYZ] Subdivision Association, Inc.

EXHIBIT A

LEGAL DESCRIPTION OF PROPERTY

EXHIBIT B

BYLAWS OF [XYZ] SUBDIVISION ASSOCIATION, INC.

APPENDIX F
CONDOMINIUM DECLARATION

**DECLARATION OF CONDOMINIUM
OF
[XYZ] CONDOMINIUM**

Date: _____, 20__

This instrument prepared by:

Melinda E. Sellers
Burr & Forman LLP
420 North 20th Street
Suite 3400
Birmingham, Alabama 35203

ARTICLE VI MAINTENANCE AND OPERATION OF THE CONDOMINIUM PROPERTY	15
Section 6.01 The Association's Obligation to Repair.....	15
Section 6.02 Each Owner's Obligation to Repair.....	16
Section 6.03 Maintenance of Limited Common Elements.....	18
Section 6.04 Alterations, Additions and Improvements by the Association.....	19
Section 6.05 Utilities and Services.....	19
ARTICLE VII RESTRICTIONS ON USE OF UNITS, COMMON ELEMENTS	20
Section 7.01 Rules and Regulations of the Association.....	20
Section 7.02 Restrictions on Use.....	20
Section 7.03 Lease of Units.....	22
Section 7.04 Right of Access	23
Section 7.05 Limitation of Liability.....	23
Section 7.06 Abatement of Violations	24
Section 7.07 Failure of the Association to Insist on Strict Performance; No Waiver	24
ARTICLE VIII RIGHTS OF MORTGAGEES	24
Section 8.01 Notification of Mortgagees Required.....	24
Section 8.02 Right of Inspection	24
Section 8.03 Priority of Mortgagees.....	25
Section 8.04 Request for Protection by Mortgagees	25
ARTICLE IX CASUALTY LOSS AND INSURANCE.....	26
Section 9.01 Responsibility of Owners; Separate Insurance Coverage.	26
Section 9.02 Insurance to be Maintained by the Association.....	26
Section 9.03 Governing Provisions	28
Section 9.04 Premiums and Deductibles	29
Section 9.05 Insurance Trustee.	29
Section 9.06 Loss to Common Elements Only.....	30
Section 9.07 Loss to Common Elements, Limited Common Elements and/or Units	30
Section 9.08 Estimates of Repair; Plans and Specifications; Payment of Assessments.....	31
ARTICLE X CONDEMNATION	32
Section 10.01 Condemnation Considered a Casualty Loss.....	32
Section 10.02 Partial Condemnation	32
Section 10.03 Association Appointed As Attorney-In-Fact for Unit Owners	34
ARTICLE XI TERMINATION.....	34
Section 11.01 Termination by Consent	34
Section 11.02 The Association Appointed as Attorney-In-Fact for Unit Owners	34
ARTICLE XII CONTROL OF THE ASSOCIATION.....	34
Section 12.01 Election of Board of Directors	34
Section 12.02 Notice of Meeting.....	35
Section 12.03 Status of Unsold Units.....	35

Section 12.04 Professional Management and Other Contracts36

ARTICLE XIII AMENDMENT.....36

Section 13.01 Amendment36

Section 13.02 Effectiveness of Amendments.....37

ARTICLE XIV DISPUTE RESOLUTION37

Section 14.01 Agreement to Resolve Disputes Without Litigation.37

Section 14.02 Dispute Resolution Procedures.38

Section 14.03 Initiation of Litigation by Association.40

ARTICLE XV MISCELLANEOUS.....41

Section 15.01 Rights and Powers of Successors and Assignees41

Section 15.02 Headings41

Section 15.03 Mold and Mildew; Potential for Water Intrusion41

Section 15.04 Gender/Number41

Section 15.05 Exhibits.....41

Section 15.06 Invalidity and Severability41

Section 15.07 Interpretation41

EXHIBITS

Exhibit "A" Legal Description of Property

Exhibit "B" Additional Property

Exhibit "C" Bylaws of the Association

Exhibit "D" Plat and Plan of the Condominium

Exhibit "E" Allocated Interests, Limited Common Elements Assignments and Votes

Exhibit "F" Allocated Interests upon Addition of Additional Property

Exhibit "G" Easements and Restrictions of Record

**DECLARATION OF CONDOMINIUM
OF
[XYZ] CONDOMINIUM**

THIS DECLARATION is made this ____ day of _____ 20__, by [_____] (the "Developer"), pursuant to the provisions of the Alabama Uniform Condominium Act of 1991, CODE OF ALABAMA 1975 §§ 35-8A-101 *et seq.* (the "Act"), for the purpose of forming a condominium and establishing certain easements, covenants and restrictions to run with the land:

W I T N E S E T H:

WHEREAS, Developer is the owner of certain real property located in the City of Mountain Brook, Jefferson County, Alabama, more particularly described on Exhibit "A" attached hereto on which is located ____ (__) building, containing ____ (__) levels with ____ (__) Units on each level. The entire Condominium initially shall contain _____ (__) Units and certain other improvements in accordance with the Plan (as defined below) a copy of which is included in Exhibit "D" attached to this Declaration (the "Property" or "Condominium Property");

WHEREAS, the Developer reserves the right to (i) add Additional Property (hereinafter defined) to the Condominium, (ii) create additional Units and Common Elements in the Condominium, (iii) construct patios, terraces, rooftop amenities, boat slips, and other recreational amenities within the Condominium Property and/or the Additional Property, subject to the terms and conditions set forth herein; and

WHEREAS, it is the desire and intent of the Developer, by recording this Declaration, to establish a condominium (as defined in the Act) to be known as [XYZ] Condominium under the provisions of the Act and to impose upon the Property mutually beneficial restrictions under a general plan for the benefit of all of the Condominium Units contained therein and the Owners thereof.

NOW, THEREFORE, Developer, upon recording hereof, does submit the Property to the provisions of the Alabama Uniform Condominium Act of 1991 to be held, conveyed, hypothecated, encumbered, leased, used, occupied, improved and in any other manner utilized subject to the provisions of said Act and subject to the covenants, conditions, restrictions, uses, limitations and affirmative obligations set forth in this Declaration, all of which are declared and agreed to be in furtherance of a plan for the improvement of said property and the division thereof into condominium ownership and all of which shall run with the land and shall be binding on all parties (including Owners as hereinafter defined) having or acquiring any right, title or interest in the Property or any part thereof, and shall be for the benefit of each Owner of any portion of the Property or any interest therein, and shall inure to the benefit of and be binding upon each successor in interest to the Owners thereof.

ARTICLE I

DEFINITIONS

Section 1.01 Definitions Initially capitalized terms as used in this Declaration shall be defined as follows, unless the context clearly indicates a different meaning therefore:

(a) **"Act"** shall mean the Alabama Uniform Condominium Act of 1991, CODE OF ALABAMA §§ 35-8A-101 *et seq.*, as the same may be amended from time to time.

(b) **"Additional Property"** shall mean all or any portion of the real property described on Exhibit "B" attached hereto and the improvements now or hereafter constructed thereon including Units and Common Elements, which property may be submitted in whole or in part in one or more phases to the Condominium, in Developer's sole discretion.

(c) **"Association"** shall mean [XYZ] Condominium Association, Inc., a nonprofit corporation organized pursuant to the Alabama Nonprofit Corporation Law, CODE OF ALABAMA §§ 10A-1-1.01 *et seq.*, of which all Owners shall be members and which corporation shall administer the operation, management, maintenance, and administration of the Condominium Property.

(d) **"Board of Directors"** or **"Board"** shall mean the Board of Directors of the Association, appointed or elected pursuant to the Bylaws of the Association.

(e) **"Bylaws"** shall mean the set of Bylaws, a copy of which is attached hereto as Exhibit "C", recorded simultaneously with this Declaration.

(f) **"Certificate of Formation"** shall mean the Certificate of Formation of the Association recorded as Entity No. _____ in the Office of the Secretary of State of the State of Alabama, on _____, 20__, as said Certificate may be amended from time to time.

(g) **"Common Elements"** shall mean and include the following:

(i) The Land;

(ii) The foundations and footings, bearing walls, perimeter walls, structural slabs, columns, beams and supports;

(iii) The balconies, roof, hallways, elevator, mechanical equipment, garbage, and storage areas designated as Common Elements on the Plat or for common use, stairways and entrances and exits or communication ways, some of which may be designated as Limited Common Elements;

(iv) The compartments or installations of central services such as central air conditioning, ventilation, heating, power, light, electricity, fire protection,

security, cold and hot water, plumbing, reservoirs, water tanks and pumps, sewer lines, flues, and the like, and all similar devices and installations existing for common use, but excluding all compartments or installations of utilities and services which exist for private use in the Units;

(v) The premises and facilities, if any, used for the maintenance or repair of the Property;

(vi) The grounds, courtyard, landscaping, sidewalks and central mail boxes;

(vii) All easements, rights or appurtenances affecting or relating to the use of the Condominium Property; and

(viii) All other elements (other than the Units) desirable or rationally of common use or necessary to the existence, upkeep and safety of the Condominium Property.

(h) **"Common Expenses"** shall mean the expenses arising out of the ownership of the Common Elements for which the Owners are liable to the Association and shall include, but not be limited to, expenses of administration of the Condominium Property; expenses of insurance; expenses of maintenance, operation, repair, replacement, rehabilitation, restoration, renovation and betterment of the Common Elements and any portion of a Unit maintained by the Association; any valid charge against the Condominium Property as a whole; a proportionate share of all Master Association Expenses; and expenses declared to be Common Expenses by the provisions of the Condominium Documents, as the same may be amended, from time to time, in accordance with the provisions thereof.

(i) **"Common Surplus"** shall mean the excess of all the receipts of the Association including, but not limited to, assessments, rents, profits and revenues over the amount of the Common Expenses.

(j) **"Condominium Documents"** shall mean this Declaration of Condominium and all Exhibits hereto, the Bylaws, the Certificate of Formation of the Association, as the same shall be amended from time to time and the Rules and Regulations of the Association.

(k) **"Declaration of Condominium"** or **"Declaration"** shall mean this instrument and all Exhibits hereto as it, from time to time, may be amended.

(l) **"Developer"** or **"Declarant"** shall mean [XYZ] DEVELOPMENT, LLC, an Alabama limited liability company, or such other person, who shall receive by assignment from the said Developer all, or a portion of its rights hereunder as such Developer, by an instrument expressly assigning such rights as Developer to such assignee.

(m) **"Land"** shall mean the parcel or tract of real estate described in Exhibit "A" to this Declaration, submitted to the provisions of the Act.

(n) **"Limited Common Elements"** shall mean and include any area designated as Limited Common Elements on the Plan and any amendment to the Plan and any areas defined in the Act as Limited Common Elements including parking spaces and storage units. The Limited Common Elements shall include among any other property so designated, the balconies, patios, and terraces, elevators, the chutes, flues, wires, conduit, bearing walls, bearing columns or any other fixture serving only that Unit. Should any Limited Common Element ever be determined not to be a Limited Common Element under the Act, the same shall be part of the Common Elements with an exclusive easement of use appurtenant to the Unit to which it was originally assigned as a Limited Common Element.

(o) **"Limited Common Expenses"** shall mean the expenses arising from the maintenance or repair of the Limited Common Elements for which the Unit Owners to which the Limited Common Elements are appurtenant shall be liable to the Association. Limited Common Expenses may include, but not be limited to, the expenses of maintenance, operation, repair, replacement, rehabilitation, restoration, renovation, and betterment of the Limited Common Elements; and expenses declared to be Limited Common Expenses by the provisions of the Condominium Documents, as the same may be amended, from time to time, in accordance with the provisions thereof.

(p) **"Master Association"** shall mean the [XYZ] Subdivision Association, Inc., an Alabama nonprofit corporation created by filing the Certificate of Formation of the [XYZ] Subdivision Association, Inc. in the Office of the Secretary of State of the State of Alabama with File Number _____.

(q) **"Master Common Areas"** shall mean those areas designated as [_____] as shown on the [XYZ] Condominiums Final Plat recorded in the Probate Office in Map Book _____, Page __ and all improvements as have been or may be constructed thereon including [_____].

(r) **"Mortgage"** shall mean a first lien Mortgage on one or more Units.

(s) **"Mortgagee"** shall mean a holder of a Mortgage who has given notice to the Association that it is the holder of a first Mortgage encumbering a Unit and has provided an address for written notices.

(t) **"Occupant"** shall mean a person or persons in possession of a Unit including family members, tenants, invitees or guests, regardless of whether that person is the Unit Owner. Each Unit Owner shall be responsible for the acts or omissions of any Occupant of such Owner's Unit.

(u) **"Owner"** or **"Unit Owner"** shall mean and refer to every person or entity who is an owner of a Unit.

(v) **"Plan"** or **"Plat"** shall mean the plat and plans showing the Units, the Common Elements and the Limited Common Elements of the Condominium Property attached hereto as Exhibit "D" and recorded in Instrument Number _____ in the Probate Office, and made a part hereof for all purposes, as such Plan may from time to time be amended.

(w) **"Probate Office"** shall mean the Office of the Judge of Probate of Jefferson County, Alabama.

(x) **"Property"** or **"Condominium Property"** shall mean the Land and all improvements and structures erected, constructed or contained therein or thereon, including the building, and all easements, rights and appurtenances belonging thereto, and all furniture, furnishings, fixtures and equipment intended for the mutual use, benefit or enjoyment of the Owners, submitted to the provisions of the Act under this Declaration, as amended from time to time.

(y) **"Rules and Regulations"** shall mean those Rules and Regulations adopted from time to time by the Board of Directors of the Association that are deemed necessary for the enjoyment of the Condominium Property, provided they are not in conflict with the Act or the Condominium Documents.

(z) **"Unit"** or **"Condominium Unit"** shall mean the parts of the Condominium Property as set forth in the Plan intended for the exclusive ownership and possession by a Unit Owner. The Unit is identified in a diagrammatic floor plan of the floor on which the Unit is situated as shown on the Plan and shall consist of the volumes or cubicles of space which lie between the lower, upper and lateral or perimetrical boundaries described as follows:

(i) *Upper and Lower Boundaries:* The upper and lower boundaries extended to their planer intersections with the perimetrical boundaries as follows:

(A) The upper boundary shall be the horizontal plane of the lower unpainted surface of the material which constitutes the ceiling or the plane of the lower surface of any exposed beam or joist that is a part of the ceiling;

(B) The lower boundary shall be the horizontal plane of the upper unpainted or unfinished surface of the material which serves as the Unit's floor. Any floor covering such as subflooring, painting, carpeting, finishing, hardwood or ceramic tile is part of the Unit.

(ii) *Perimetrical Boundaries:* The perimetrical boundaries shall be the vertical planes of the exterior surfaces of the exterior windows and exterior doors, and the interior unpainted surfaces of the material which forms the perimeter wall of the Unit. All sheetrock, wall boards, including paint, wallpaper and light coverings, extended to their planer intersections with each other and with the upper and lower boundaries are part of the Unit.

Each Unit shall include all non-structural interior partition walls located within the boundaries of the Unit except such part as may comprise part of the Common Elements; the decorated surfaces of all boundary walls, ceilings and floors, including wallpaper, paint, interior brick surface, lathe, wallboard, plaster, carpeting, flooring and other finishing materials; all immediately visible fixtures, appliances, cabinets, and water and sewer pipes located within the boundaries of the Unit and serving only the Unit; and the mechanical systems and installations providing electrical power, gas, water, heating and air conditioning service to the Unit, including the individual compressor or meter even though such equipment may be located outside the boundaries of the Unit, provided that no pipes, wires, conduits, ducts, flues, shafts and other facilities situated within such Unit and forming a part of any system serving one or more other Units or the Common Elements shall be deemed to be a part of such Unit; and provided further that no bearing wall, joist, or beam providing structural support and located within the boundaries of the Unit shall be deemed part of the Unit.

ARTICLE II

PROPERTY SUBJECT TO THIS DECLARATION

Section 2.01 Description of Improvements and Identification of Units. The Condominium Property shall initially consist of ____ () building containing ____ () levels with ____ () Units on each level; the total building containing _____ () Units. A plat of the Land and improvements thereon and a graphic description of the improvements in which the Units are located, identifying each Unit by a number and/or letter so that no Unit bears the same designation as any other Unit, all in sufficient detail to identify the Common Elements, the Limited Common Elements and each Unit and their relative locations and approximate dimensions, are set forth in the Plan attached hereto as Exhibit “D”. There is no obligation to submit any Additional Property or additional phases to the Condominium.

Section 2.02 Amendment of Condominium Plan. Developer reserves the right to change the interior design and arrangement of any Unit, to alter the boundaries between Units and to increase or decrease the number of Units so long as the Developer owns the Units so altered. Developer reserves the right to create additional Units and Limited Common Elements from the Common Elements. Also, Developer reserves to itself or any subsequent Owner the right to combine two or more Units or to subdivide any of the Units into as many Units as Developer or the Unit Owner determines, in its sole discretion, which number shall not exceed _____ () Units. Upon subdivision of any Unit, the allocated interests assigned to the Unit subdivided shall be allocated to the resulting Units as determined by the Developer or such affected Unit Owner but which total allocated interests shall not exceed the amount originally assigned to the single Unit. Changes in the boundaries between the Units, as hereinbefore provided, shall be reflected by an amendment to the Plan, and if necessary, an amendment to this Declaration. An amendment to the Plan or the Declaration reflecting an alteration of the boundaries of the Units or addition of Units need be signed and acknowledged only by the Developer or affected Unit Owner and need not be approved by the other Owners and Mortgagees, whether or not such approval may elsewhere be required herein.

Section 2.03 Easements and Restrictions. The Units, Common Elements and Limited Common Elements shall be, and the same are hereby declared to be subject to the

restrictions, easements, conditions and covenants prescribed and established in the Condominium Documents governing the use of said Units, Common Elements and Limited Common Elements in setting forth the obligations and responsibilities incident to ownership of each Unit and its appurtenant undivided interest in the Common Elements. The Units, Common Elements and Limited Common Elements are further declared to be subject to the restrictions, easements, conditions and limitations now of record affecting the Condominium Property, which easements and restrictions are described on Exhibit "G" attached hereto. Additional easements established hereunder include the following:

(a) Utility Easements. Utility easements are reserved throughout the whole of the Property, including Units, as may be required for utility services (including, without limitation, water, sewer, gas, electricity, telephone, internet and cable television) in order to adequately serve the Condominium Property.

(b) Utility Equipment. There may be utility equipment which is appurtenant to the Units, but which is located on the Common Elements. An easement is hereby reserved in favor of each Unit for the purpose of placement, maintenance, repair and replacement of said utility equipment by Developer and the Owners of the Unit; provided that no utility equipment shall be placed on any part of the Common Elements or Limited Common Elements other than the present location unless the written approval of the Association shall have been first obtained.

(c) Easements for Ingress and Egress. The Common Elements shall be, and the same are hereby declared to be subject to a perpetual nonexclusive easement of way over all walkways, halls, stairways, and other common areas in favor of all Owners for all proper and normal purposes and for the furnishing of services and facilities for which the same are reasonably intended for the enjoyment of said Owners, subject to all restrictions in the Condominium Documents.

(d) Easement for Use of Leased or Acquired Property. Each Unit Owner shall have a nonexclusive easement for use of any property hereafter acquired by the Association for the common benefit of the Owners by purchase, lease or otherwise for all normal and proper purposes for which the same are reasonably intended, subject to all restrictions in the Condominium Documents and the Rules and Regulations.

(e) Easements for Encroachments. To the extent that any Unit, Common Element or Limited Common Element encroaches on any other Unit, Common Element, or Limited Common Element, whether by reason of any deviation from the Plan in the original construction, repair, renovation, restoration or replacement of any improvement, or by reason of the settling or shifting of any land or improvement, a valid easement shall exist for the encroachment and/or the maintenance of the same, so long as the encroaching Unit, Common Element or Limited Common Element stands. This easement, however, shall not relieve an Owner of liability for his or his agent's negligence, intentional acts or willful and intentional misconduct in causing the encroachment. In the event any Unit, any adjoining Unit, or any adjoining Common Elements or Limited Common Elements shall be partially or totally destroyed as a result of fire or other casualty or as a result of

condemnation or eminent domain proceedings, and then constructed, reconstructed or repaired, encroachment of parts of the Common Elements or Limited Common Elements upon any Unit, or encroachment of any Unit upon any other Units, Common Elements or Limited Common Elements resulting from such construction, reconstruction or repair shall be permitted, and valid easements for such encroachment and the maintenance thereof shall exist so long as the encroaching improvements shall stand.

(f) Easement for Services and Emergencies. There shall be nonexclusive easements for all police, firemen, ambulance operators, mail carriers, delivery services, garbage service workers, and all similar persons, and the Association, but not the public in general, to enter upon the Common Elements in the performance of their duties, subject to reasonable rules and regulations as the Board may establish from time to time.

(g) Easement of Support. Each Unit and the Common Elements and Limited Common Elements shall have an easement of support from every other Unit, Common Elements or Limited Common Elements which provide such support.

(h) Easement for Use of Limited Common Elements. Each Owner shall have an easement for the use and upkeep of the Limited Common Elements appurtenant to his Unit and for ingress and egress to and from the Limited Common Elements for so long as the Limited Common Elements exist. The aforesaid easement shall be for the benefit of each Unit Owner to which the Limited Common Element is appurtenant.

(i) Easements Appurtenant to Units. The easements and other rights created herein for the Unit Owners shall be appurtenant to the Unit of that Owner and all conveyances of title to the Unit shall include a conveyance of the easements and rights as are herein provided even though no specific reference to such easements and rights appear in such instrument. The Owners do hereby designate the Developer and/or the Association as their lawful attorney-in-fact to execute any and all instruments on their behalf for the purpose of creating all such easements as are contemplated by the provisions hereof.

(j) Easements in Favor of Additional Property. There shall be a perpetual non-exclusive easement for vehicular and pedestrian ingress and egress over the Common Elements of the Property for the benefit of the Developer and the owners of the Additional Property for all purposes incident to the development of the Additional Property. Further, there shall be a perpetual, non-exclusive easement for the benefit of the Developer and the owners of the Additional Property for the maintenance and use of all sewage disposal, storm drainage and utility distribution systems and facilities as are presently located on the Property, and for the maintenance and use of such sewage disposal, storm drainage and utility distribution systems and facilities as may be constructed or installed on the Property in the future.

Section 2.04 Ownership of Common Elements. Each Owner shall own an undivided interest in the Common Elements with all other Owners, and, except as otherwise limited in this Declaration, shall have the right to use the Common Elements for all purposes incident to the use and occupancy of the Unit as herein provided, without hindering or encroaching upon the lawful rights of the other Owners, which rights shall be appurtenant to and run along with

the Units. The extent or amount of such ownership shall be expressed by a percentage relating to each Unit and shall remain constant, unless changed in accordance with the provisions of Section 2.02 or Article III hereof or by the unanimous approval of all Owners and Mortgagees affected hereby. The percentage ownership in the Common Elements relating to each Unit is set forth on Exhibit "E" attached hereto.

Section 2.05 Rights in or to Limited Common Elements.

(a) The Limited Common Elements appurtenant to the Unit shall be as described by the Act, as shown on the Plan, a copy of which is attached as Exhibit "D," and/or as set forth in the chart attached hereto as Exhibit "E." The description shall be expressed by identifying the type of Limited Common Elements which are appurtenant to the Unit, if any, and the Owners of such Units shall have the exclusive right to use such Limited Common Elements so designated or described unless changed by the Developer as permitted in Section 2.02 or Article III hereof or by the unanimous approval of the Owners of the Units to which Limited Common Elements are appurtenant and their respective Mortgagees. Each Owner of a Unit to which the Limited Common Element is appurtenant shall have the right to use the Limited Common Element for all purposes incident to the use and occupancy of his Unit as herein provided without hindering or encroaching upon the lawful rights of the other Owners, which rights shall be appurtenant to and run along with the Units to which the Limited Common Elements are attached.

(b) The hallways on each level of the building are Limited Common Elements appurtenant to the Units located on that level.

ARTICLE III

**DEVELOPMENT RIGHTS TO ADD
ADDITIONAL PROPERTY TO THE CONDOMINIUM**

Section 3.01 Reservation of Development Rights. Developer reserves the right, but has no obligation, to add all or any portion of the Additional Property described on Exhibit "B" attached hereto, together with any improvements constructed thereon, which may eventually consist of as many as _____ () additional Units, Common Elements and Limited Common Elements (including boat slips) to the Condominium Property within ten (10) years from the conveyance of the first Unit in the Condominium, in one or more additional phases; the total condominium shall never contain more than _____ () Units. Any future phase of the Condominium may include recreational facilities as well as additional Units, Common Elements and/or Limited Common Elements. Developer also reserves the right to designate portions of Common Elements in the initial Condominium as Limited Common Elements to initial Condominium Units should it develop the Additional Property. For example, the Common Elements of the building in the initial Condominium could be designated as Limited Common Elements for the exclusive use of the Unit Owners in that building rather than in the future phases. The style and size of any additional building added to the Condominium shall be within Developer's sole discretion. Any additional improvements to be constructed on any portion of the Additional Property that is submitted to the Condominium shall be of substantially the same

quality as the currently existing improvements in the Condominium. The submission of the Additional Property may be accomplished in one or more phases within the ten (10) year period, by filing an amendment to this Declaration and the Plat and Plans, which amendment(s) only need to be signed by the Developer and the Developer's Mortgagee, if any. If all or any portion of the Additional Property is later submitted to the condominium form of ownership by amendment to this Declaration, the Additional Property may only be added if developed in conjunction with the allocation of percentage ownership of the Common Elements, the sharing of Common Expenses, and the allocation of voting rights as set forth on Exhibit "F" attached hereto. Nothing contained herein shall obligate the Developer to submit the Additional Property to the Condominium; however, the Developer may submit all, part or none of the Additional Property to the Condominium. Prior to being added to the Condominium, if so added, no portion of the Additional Property shall be subject to this Declaration. If any portion of the Additional Property is added to the Condominium, only such portion added shall be subject to this Declaration. Any part of the Additional Property not submitted to the Condominium may be developed or used by the Developer in any manner it deems proper, including the development of another mixed-use project.

Section 3.02 Exercise of Development Rights. Except as otherwise specifically set forth in this Declaration, there shall be no limitations on the development right to add any portion of the Additional Property, Units, Common Elements, and/or Limited Common Elements to the Condominium or the exercise thereof. The right may be exercised to add all or any portion of the Additional Property to the Condominium at one time or at different times, or the right may not be exercised at all, in Developer's sole discretion. There shall be no limitations to the boundaries of any portion of the Additional Property added to the Condominium. The exercise of the right to add a portion of the Additional Property, which may contain Units, Common Elements and/or Limited Common Elements to the Condominium shall not prohibit Developer from, or obligate Developer to, further exercise of the right as to any other portion of the Additional Property.

Section 3.03 Expiration of Development Rights. The development rights set forth herein, specifically including the right to submit all or any portion of the Additional Property to the Condominium may be exercised by Developer at any time and from time to time for a period of ten (10) years from the date of recording this Declaration in the Probate Office. Upon the expiration of said ten (10) year period, to the extent not exercised or previously terminated by Developer by express amendment to this Declaration, the right shall expire and terminate; provided, however, that Developer may extend said period for the exercise of the development rights with the consent of the Unit Owners of Units to which two-thirds (2/3) of the votes in the Association appertain within one (1) year prior to the date upon which the development rights would otherwise have expired.

Section 3.04 Improvements on Additional Property. Any and all structures erected on any portion of the Additional Property or improvements to the Additional Property if added to the Condominium will be compatible with the structures on the Property in terms of physical appearance, structure, type, quality of construction, and architectural style. The maximum number of Units that ever may be in the Condominium is seventy-five (75) Units. There are no limitations as to the particular location or type of any improvements that may be made on any portion of the Additional Property added to the Condominium. Developer shall have the right,

but not the obligation, to construct such improvements on the Additional Property, or any portion thereof added to the Condominium as Developer shall deem advisable for the common use and enjoyment of the Unit Owners, including limited common element boat slips. No limitations are placed on the right of Developer reserved hereby to create Limited Common Elements within any portion of the Additional Property or to designate Common Elements therein which may subsequently be assigned as Limited Common Elements. Except as expressly provided in this Section, there are no assurances that any Units created on any portion of the Additional Property added to the Condominium will be substantially identical to the Units submitted with this Declaration and there are no assurance as to what types of Units may be created on the Additional Property. All improvements on the Additional Property will be substantially completed in accordance with the Act prior to being added to the Condominium.

Section 3.05 Reallocations and Amendment. Upon the addition of any portion of the Additional Property containing Units to the Condominium, the share of undivided interest in the Common Elements and the share of liability for Common Expenses and Limited Common Expenses allocable to all Units then included in the Condominium shall be reallocated in accordance with the formula set forth on Exhibit "F," subject to the right of Developer to make adjustments based upon the number of additional Units added, so that the total of all interests equals 100%. Each Unit located upon any portion of the Additional Property added to the Condominium shall be allocated the number of votes in the Association as are comparable to the votes allocated to the existing Units of comparable size in the Condominium. Notwithstanding anything contained in this Declaration to the contrary, to add all or a portion of the Additional Property to the Condominium, Developer (and its lender, if any) alone shall execute and record an amendment to this Declaration and the Plan, submitting such portion of the Additional Property to the Act and this Declaration and reallocating the undivided interests in the Common Elements, the liabilities for Common Expenses and the votes in the Association.

ARTICLE IV

ORGANIZATION AND MANAGEMENT OF THE ASSOCIATION

Section 4.01 Management of the Condominium Property. Operation and administration of the Condominium Property shall be performed by the Association. The powers and duties of the Association shall include those set forth in the Act, the Alabama Nonprofit Corporations Act, CODE OF ALABAMA 1975 §§ 10A-1-1.01 *et seq.*, this Declaration, the Certificate of Formation and the Bylaws of the Association.

Section 4.02 Members. The members of the Association shall consist of all record Unit Owners. Change of membership in the Association shall be established by recording in the public records of Jefferson County, Alabama, the deed or other instrument establishing record title to a Unit in the Condominium Property, the Owner designated by such instrument thereby becoming a record Owner and a member of the Association. Membership of the prior Owner shall thereby be terminated. All present and future Owners and Occupants of the Units shall be subject to and shall comply with the provisions of the Declaration, the Bylaws and the Rules and Regulations, as the same may be amended from time to time. The votes for a Unit shall be cast by the record Owner thereof or the duly authorized proxy of the record Owner in the manner

provided in the Bylaws. Each Unit Owner is entitled to the number of votes for each Unit owned by him as set forth in Exhibit “E” attached hereto.

Section 4.03 Bylaws. The Bylaws of the Association shall be in the form attached as Exhibit “C” to this Declaration, and may be amended from time to time as set forth therein.

Section 4.04 Voting Requirements. Unless a specific voting requirement in excess of a simple majority is required by this Declaration or the Bylaws for either a vote of the Board of Directors or a vote of members, any such voting requirements shall be construed to require only a simple majority vote.

Section 4.05 Master Association. The Owners will be required to pay a pro rata share of Master Association Expenses. Each Unit Owner shall be a member of the Master Association.

ARTICLE V

ASSESSMENTS

Section 5.01 Liability, Lien and Enforcement. The Association is given the authority to administer the operation and the management of the Condominium Property, it being recognized that the delegation of such duties to one entity is in the best interest of the Owners of all Units. To provide the funds necessary for such proper operation, the Association is hereby granted the right to make, levy, and collect annual assessments against the Owners of all Units to pay Common Expenses and such other expenses which the Association is authorized to incur under the terms and conditions of this Declaration. The Association is also authorized to make, collect and levy assessments against Unit Owners for reimbursement of expenses the Association is caused to incur by reason of any act of the Unit Owner, his family members, guests, invitees or tenants for damages of any nature and for fines for rules violations. In furtherance of said grant of authority to the Association to make, levy and collect assessments to pay the costs and expenses for the operation and management of the Condominium Property and said fines, the following provisions in this Article V shall be effective and binding upon the Owners of all Units.

Section 5.02 Assessments.

(a) All assessments for the payment of Common Expenses shall be levied annually against the Owners of all Units, and unless specifically otherwise provided for in this Declaration, each Owner of a Unit and his Unit shall bear the same percentage share of such assessment as the percentage share of ownership for the undivided interest in the Common Elements appurtenant to said Unit. The Association may include the common expense assessments levied against the Units by the Master Association as a part of the Common Expenses. The assessments for Common Expenses shall be payable over the course of the year in advance monthly installments commencing on the date of purchase of a Unit or in such other installments and at such times as may be determined by the Board of Directors of the Association.

(b) Assessments for the payment of Limited Common Expenses may be levied against the Owners of those Units to which the Limited Common Elements are appurtenant if the Board of Directors determines that it is the most equitable method of assessment for Limited Common Expenses. The Limited Common Expenses may also be included in Common Expenses and assessed in the same proportion as Common Expenses if the Board of Directors chooses this method of assessment. The assessments for Limited Common Expenses, if any, shall be payable in such installments and at such times as may be determined by the Board of Directors of the Association.

(c) The Association may assess the Owners of Units for the repair and maintenance of various components of the Common Elements or Limited Common Elements based on the usage of any component of the Common Elements or Limited Common Elements. Such assessments shall not be included in the assessment for Common Expenses, but shall be payable in such manner and at such times as may be determined by the Board of Directors of the Association.

Section 5.03 Annual Budget. Within sixty (60) days prior to the beginning of each calendar year, the Board of Directors of the Association shall adopt a proposed annual budget for such calendar year, and such budget shall project the amount of funds for the forthcoming year which may be required for the proper operation, management and maintenance of the Condominium Property, including reasonable allowances for contingencies and reserves therefore, in accordance with the Act and this Declaration. Said budget shall take into account any projected anticipated income which is to be applied in reduction of the amounts required to be collected as an assessment each year. Within thirty (30) days after adoption of such annual budget by the Board of Directors of the Association, copies of said budget shall be made available to each Unit Owner and the Board shall set a date for a meeting of the Unit Owners to consider ratification of the budget not less than ten (10) nor more than thirty (30) days after delivery of the budget to the Unit Owners. Unless at the meeting a majority of the Unit Owners present in person or by proxy reject the budget, the budget is ratified, whether or not a quorum is present. In the event the proposed budget is rejected the budget for the last year shall continue in effect until such time as a new budget is ratified. If the budget is ratified the assessments for said year shall be established based upon such budget.

Should the Board of Directors at any time determine in the sole discretion of said Board of Directors that the assessments levied are or may prove to be insufficient for any reason including emergencies and non-payment of any Owner's assessment, the Board of Directors shall have authority to levy such additional assessments as it shall deem necessary in accordance with the applicable provisions of the Condominium Documents and the Act.

Section 5.04 Omission of Assessment. The omission by the Association, before the expiration of any year, to fix the assessments for that or the next year shall not be deemed a waiver or modification in any respect of the provisions of this Declaration, or a release of any Owner from the obligation to pay assessments or any installment thereof for that or any subsequent year, but the assessment fixed for the preceding year shall continue until a new assessment is fixed.

Section 5.05 Detailed Records. The Association shall keep detailed, accurate records in chronological order of the receipts and expenditures and any other expenses incurred. Records and vouchers authorizing the payments involved shall be available for examination by any Owner or his representative at convenient hours of weekdays in the county where the Condominium is located.

Section 5.06 Payment of Common Expenses and Limited Common Expenses by Unit Owners. All Unit Owners shall be obligated to pay any assessment for Common Expenses and Limited Common Expenses adopted by the Board of Directors pursuant to the terms of this Article V. No Unit Owner may exempt himself from liability for his contribution toward Common Expenses or Limited Common Expenses by waiver of the use or enjoyment of any of the Common Elements, Limited Common Elements or by abandonment of his Unit. No Unit Owner shall be liable for the payment of any part of the Common Expenses or Limited Common Expenses assessed against his Unit subsequent to a sale or other conveyance by him of such Unit. The purchaser of a Unit shall be jointly and severally liable with the selling Unit Owner for all unpaid assessments against the latter up to the time of conveyance without prejudice to the purchaser's right to recover from the selling Unit Owner the amounts paid by the purchaser therefore. Whenever any Unit may be sold or mortgaged by the Owner thereof, which sale shall be concluded only upon compliance with the other provisions of this Declaration, the Association, upon written request of the Owner of such Unit, shall furnish to the Owner (within the time period prescribed by the Act) a statement verifying the status of the payment of any assessment which shall be due and payable to the Association by the Owner of such Unit and the other information required by the Act. Any purchaser or proposed Mortgagee may rely upon such statement in concluding the proposed lease, purchase or mortgage transaction and the Association shall be bound by such statement. In the event that a Unit is to be sold or mortgaged when any assessment is outstanding against the Owner of such Unit and such assessment due the Association is in default, the purchase or mortgage proceeds shall first be paid by purchaser or Mortgagee to the payment of any delinquent assessment or installment due the Association before the payment of the proceeds to or on behalf of the selling Unit Owner.

Section 5.07 Default in Payment of Assessments.

(a) The payment of any assessment or installment thereof due the Association shall be in default if such assessment or any installment thereof is not paid to the Association on or before the due date for such payment. When in default, the delinquent assessment or delinquent installment due the Association shall bear interest at eighteen percent (18%) until such delinquent assessment or installment and all interest due thereon has been paid in full. The Association shall have a lien against Units for delinquent assessments. Said lien shall secure and does secure the monies due for all assessments then or thereafter levied against the Unit, and such lien shall also secure interest, if any, which may be due on the amount of any delinquent assessment owing the Association. Said lien shall also secure all costs and expenses, including late penalties and reasonable attorneys' fees incurred by the Association in collecting delinquent assessments and enforcing the lien upon said Unit and its appurtenant undivided interest in the Common Elements or Limited Common Elements. The lien granted to the Association may be foreclosed in the same manner as real estate mortgages in the State of Alabama containing a power of sale

pursuant to Alabama Code §§ 35-10-11 *et seq.* as it may be amended, but the Association shall give reasonable advance notice of its proposed action to the Unit Owner, the Mortgagee and all other lienholders of record. The lien granted to the Association shall further secure such advances for taxes and payment on account of superior mortgages, liens or encumbrances which may be required to be advanced by the Association in order to protect and preserve its lien, and the Association shall further be entitled to interest at eighteen percent (18%) on any such advance made for such purpose. All persons, firms or corporations who shall acquire, by whatever means, any interest in the ownership of any Unit or who may be given or acquire a mortgage, lien or other encumbrance thereon are hereby placed on notice of the lien rights granted to the Association and shall acquire such interest in any Unit expressly subject to the lien.

(b) The lien herein granted to the Association shall be effective from and after the time of recording in the Probate Office, the Declaration of Condominium of [XYZ] Condominium and no further recordation of any claim of lien for assessment under this section is required. Such lien shall include only assessments which are due and payable when the action to enforce the lien is commenced plus late penalties and penalties imposed by the Association for Rules and Regulations violations, interest, costs, reasonable attorneys' fees, advances to pay taxes and prior encumbrances and interest thereon, all as above provided.

Section 5.08 Required Reserve Funds. Assessments levied by the Board of Directors of the Association shall include an adequate reserve fund for maintenance, repair and replacement of those Common Elements and Limited Common Elements that must be replaced or repaired on a periodic basis, and shall be payable in regular installments. Special assessments may be levied by the Board in the event that there is insufficient money in the reserve fund for the maintenance, repair or replacement of any portion of the Common Elements or Limited Common Elements.

Section 5.09 Election of Remedies. Institution of a suit at law to collect payment of any delinquent assessments shall not be deemed to be an election by the Association which shall prevent its thereafter seeking enforcement of the collection by foreclosure of any sums remaining owing to it. Nor shall proceeding by foreclosure to effect such collection be deemed to be an election precluding the institution of a suit at law to collect any sum then remaining owing to the Association. The Association shall be entitled to bid at any sale held in connection with the foreclosure of the assessment lien and may apply as a cash credit against its bid all sums secured by the lien enforced.

ARTICLE VI

MAINTENANCE AND OPERATION OF THE CONDOMINIUM PROPERTY

Section 6.01 The Association's Obligation to Repair. The Association, acting through the Board of Directors, shall be responsible for the maintenance, repair and replacement of the following, the cost of which shall be charged to all Unit Owners as a Common Expense:

- (i) The Common Elements, which by definition excludes the surfaces of all interior walls, floors, and ceilings, of a Unit;
- (ii) Incidental damage caused to a Unit by any work done by the Association; and
- (iii) Portions of Common or Limited Common Elements contained in the Units contributing to the support of the building, including outside walls and load bearing columns, support beams, and joists excluding, however, interior wall, ceiling and floor surfaces.

The Association shall be responsible for the maintenance, repair and replacement of the exterior doors and windows of the Units, which include all surrounding encasements, framing, thresholds and wood supports, the cost of which shall be assessed against the Unit Owner. The Unit Owner shall be responsible for the maintenance, repair and replacement of the door handles and associated locks, but may not change the color or design of the door handle and associated locks without written approval of the Board of Directors. The Association, acting through the Board of Directors, also shall be responsible for the maintenance, repair and replacement of the Limited Common Elements, the cost of which shall be charged to all Unit Owners to which said Limited Common Elements being maintained repaired or replaced attach as a Limited Common Expense.

This Section 6.01 shall not relieve a Unit Owner of liability for damage to the Common Elements, Limited Common Elements, a Unit of another person, adjacent property or any other property as a consequence of the negligence, recklessness or willful misconduct of the Unit Owner, Occupant, family members, guests, invitees, lessees or licensees. The cost of repair for any resulting damage including attorneys' fees, expenses, and insurance deductibles incurred by the Association shall be a special assessment against the Unit Owner and the Unit.

Section 6.02 Each Owner's Obligation to Repair.

- (a) Except for those portions of the Condominium Property which the Association is required to maintain and repair, each Owner shall, at such Owner's expense, maintain his or her Unit in good tenantable condition and repair, and shall be responsible for the repair, maintenance and replacement, if necessary, of the following items in his Unit:
 - (i) The fixtures and equipment in his Unit, including all appliances within the Unit; drains, sinks, plumbing and plumbing fixtures and connections within the Unit and serving only the Unit; electrical panels, wiring, outlets and electric fixtures within the Unit; interior doors, interior surfaces of the window frames, screening and glass; and interior surface of all exterior doors and windows; all wall coverings including paint, wallpaper and light coverings; and all floor coverings, including carpeting, hardwood, vinyl and ceramic tile within a Unit.
 - (ii) The plumbing, heating, air conditioning and electrical systems serving only that Unit, whether located within or without the boundary of that Unit,

including the fuse boxes, wiring, flues, and all other plumbing, electrical, gas or mechanical systems. In the event any such system or a portion thereof is within another Unit or requires access to another Unit, the repair, maintenance or replacement thereof shall be performed by the Association, and the cost thereof shall constitute an assessment against the Unit Owner responsible therefore.

(b) Each Unit Owner agrees as follows:

(i) To perform all maintenance, repairs and replacements which are his obligations under subparagraph (a) of this Section 6.02;

(ii) To pay all utilities as herein provided and all taxes levied against his Unit;

(iii) Not to make, or cause to be made, repairs to any plumbing, heating, ventilation or air conditioning systems located outside his Unit but required to be maintained by him under subparagraph 6.02(a)(ii), except by licensed plumbers, electricians or heating and air conditioning professionals authorized to do such work by the Association or its delegate;

(iv) Not to make any addition or alteration to the Unit or to the Common Elements or Limited Common Elements or to do any act that would impair the structural soundness, safety or overall design scheme of any part of the Condominium Property or that would impair any easement or right of a Unit Owner without the prior written consent of the Association and all Unit Owners affected thereby;

(v) Not to make any alteration, addition, improvement, decoration, repair, replacement or change to the Common Elements, Limited Common Elements, or to any outside or exterior portion of the Unit, including, but not limited to, altering in any way exterior doors, affixing outshutters to windows or painting any part of the exterior part of the Unit, without the prior written consent of the Association; provided that if such consent is granted, the Unit Owner shall use only a contractor approved by the Association, who shall comply with all Rules and Regulations with respect to the work which may be adopted by the Association, and the Unit Owner shall be liable for all damages to another Unit or to the Common Elements or Limited Common Elements caused by any contractor employed by such Unit Owner or by the subcontractors or employees of such contractor, whether said damages are caused by negligence, accident, or otherwise;

(vi) (1) regularly inspect the parts of the Condominium that the Unit Owner maintains for the existence of mold, mildew, and/or water intrusion and/or damage; (2) upon discovery, immediately repair in a good and workmanlike condition the source of any water intrusion in the parts of the Condominium that the Unit Owner is responsible for maintaining; (3) remediate or replace any building material located in the parts of the Condominium that the Unit Owner is responsible for maintaining that has absorbed water or moisture as a result of water

intrusion; and (4) promptly and regularly remediate all mold and/or mildew discovered in the parts of the Condominium that the Unit Owner maintains in accordance with current industry-accepted methods. In addition, each Unit Owner shall notify the Association of the discovery of mold, mildew, and/or water intrusion and/or damage in the Units, and the Association shall notify the Developer of the discovery of mold, mildew, and/or water intrusion and/or damage in any part of the Condominium should the Developer own any Units at that time.

(vii) To promptly report to the Association any defects or needed repairs for which the Association is responsible; and

(viii) To promptly fix, or cause to be fixed, any violation discovered during an inspection of the Unit pursuant to Section 7.04 hereof after the Unit Owner has been provided with written notice of the violation(s). The Association may levy a fine pursuant to Section 5.01 hereof against a Unit Owner that fails to promptly address such violations.

(c) The Association shall be obligated to answer any request by a Unit Owner for any required approval of a proposed addition, alteration or improvement (by painting or otherwise) within forty-five (45) days after such request, but its failure to do so within the stipulated time shall not constitute a consent of the Association to the proposed addition, alteration or improvement. Any application to any governmental authority for a permit to make an addition, alteration or improvement in or to any Unit shall be executed by the Association, without, however, it incurring any liability on the part of the Board of Directors or any of them or the Association to any contractor, subcontractor or materialman on account of such addition, alteration or improvement, or to any person having any claim of injury to a person or damage to property arising therefrom. The review by the Association under this Section 6.02 shall in no way make the Association liable for any alterations, additions, or improvements by any Unit Owner. Rather, such review is for purposes of aesthetics and control only. The provisions of this Section 6.02 shall not apply to Units owned by the Developer until a deed for such Unit has been delivered to a purchaser other than Developer.

(d) Notwithstanding the foregoing, a Unit Owner shall not cause or permit any portion of the upper, lower, or perimetrical boundaries of a Unit to be damaged or disturbed without first receiving written permission of the Association. Developer makes no representations as to the presence on, in, under or near the Condominium Property of any material containing asbestos; however, each Unit Owner acknowledges that asbestos may be present on, in, under or near the Condominium Property, including those areas beyond the upper, lower, and perimetrical boundaries of a Unit.

Section 6.03 Maintenance of Limited Common Elements. The Limited Common Elements shall be maintained in accordance with the following:

(a) Each Unit Owner shall keep the Limited Common Elements appurtenant to the Unit in a clean, neat and presentable appearance and shall not allow such areas to be used for anything other than its intended use; and

(b) The Association shall perform all other maintenance and repair of the Limited Common Elements, the expense of which shall be a Limited Common Expense assessed against the Unit(s) and Unit Owner(s) to which the Limited Common Elements are appurtenant.

Section 6.04 Alterations, Additions and Improvements by the Association.

Except in the case of loss or damage to the Common Elements or Limited Common Elements as contemplated by Article IX of the Declaration, the Association shall not make any material structural alterations, capital additions or capital improvements to the Common Elements or Limited Common Elements the cost of which is estimated to exceed \$50,000.00 unless the same is authorized by the Board of Directors of the Association and ratified by the affirmative vote of the voting members casting not less than sixty-six and two-thirds percent (66.67%) of the total votes of the members of the Association present at any regular or special meeting of the Unit Owners called for that purpose at which a quorum is present and approved by a majority of the Mortgagees eligible to vote therefore. The cost of the foregoing shall be assessed against the Owners of Units as provided in Article V hereof except as otherwise provided in this Section 6.04. Where any alterations or additions as aforesaid are exclusively or substantially exclusively for the benefit of the Unit Owners requesting the same, then the cost of such alterations or additions shall be assessed against and collected solely from the Unit Owners exclusively, or substantially exclusively, benefiting therefrom, and the assessment shall be levied in such proportions as may be determined to be fair and equitable by the Board of Directors of the Association. Where such alterations or additions exclusively, or substantially exclusively, benefit Unit Owners requesting the same, said alterations and additions shall be made only when authorized by the Board of Directors and ratified by not less than sixty-six and two-thirds percent (66.67%) of the total votes of the Unit Owners exclusively, or substantially exclusively, benefiting there from. Alterations, improvements or repairs of an emergency nature may be made upon authorization by a vote of the majority of the Directors available for consultation if the same is necessary and in the best interest of the Unit Owners. Nothing in this Section 6.04 shall relieve the Association from its obligation to maintain, repair and replace the Condominium Property as described in the Condominium Documents and the Act.

Section 6.05 Utilities and Services. The utilities including water, power, and cable serving the Common or Limited Common Elements only shall paid by the Association as a Common or Limited Common Expense. The Association shall have authority with regard to any utility, to use a common meter, pay the cost of such utilities used or consumed in the Units, and have the costs thereof apportioned among the Units based upon the Common or Limited Common Expense liability, use of the utility, or any other formula the Association may deem appropriate or it may install separate meters for each of the Units and the Common Elements. The Association may enter into an agreement with a third party to provide internet service for the Condominium Property and may pay the cost of such internet service used or consumed on the Condominium Property, and have the costs thereof apportioned among the Units based upon the Common or Limited Common Expense liability, use of the service, or any other formula the Association may deem appropriate.

ARTICLE VII

RESTRICTIONS ON USE OF UNITS, COMMON ELEMENTS

Section 7.01 Rules and Regulations of the Association. The Association is authorized to promulgate, amend and enforce Rules and Regulations concerning the operation and use of the Condominium; provided that such Rules and Regulations are not contrary to or inconsistent with the Act and the other Condominium Documents. A copy of the Rules and Regulations shall be furnished by the Board of Directors to each Unit Owner prior to the time they become effective. All present and future Unit Owners, tenants, and Occupants of the Units and any person who uses any part of the Condominium Property in any manner, are subject to, and shall comply with the provisions of the Condominium Documents, including, without limitation, the Rules and Regulations. The acquisition, rental or occupancy of a Unit or the use of any part of the Condominium Property by any one person shall constitute his agreement to be subject to and bound by the provisions of the Condominium Documents, including, without limitation, the Rules and Regulations, and such provisions shall be deemed to be enforceable as equitable servitudes and covenants running with the land and shall bind any person having at any time any interest or estate in such Unit, as though such provisions were recited and stipulated in full in each and every deed of conveyance or lease thereof. The Association may promulgate enforcement provisions for violation of any Rule or Regulation by a member, his guests, invitees, lessees or tenants, including the payment of penalties for such violations.

Section 7.02 Restrictions on Use. The use of the Condominium Property is subject to the following restrictions:

(a) Each Unit is hereby restricted to residential use in accordance with the Rules and Regulations of the Association and as allowed by the City of Mountain Brook.

(b) There shall be no obstruction of the Common Elements, nor shall anything be kept or stored in the Common Elements, nor shall anything be constructed on or planted in or removed from the Common Elements, nor shall the Common Elements in any other way be altered without the prior written consent of the Association.

(c) No immoral, improper, offensive or unlawful use shall be made of any Unit or Common Elements or any part thereof, and all laws, zoning ordinances and regulations of all governmental authorities having jurisdiction over the Condominium Property shall be observed.

(d) No Owner shall permit anything to be done or kept in his Unit or in the Common Elements which will result in any increase of fire or hazard insurance premiums or the cancellation of insurance on any part of the Condominium Property, or which would be in violation of any law. No waste shall be committed to the Common Elements.

(e) No noxious or offensive activities shall be carried on, nor shall anything be done, on any part of the Condominium Property which in the judgment of the Board of Directors of the Association may be or become an unreasonable annoyance or nuisance to the other Owners.

(f) Smoking including, but not limited to, tobacco products or electronic cigarettes is prohibited on the Condominium Property.

(g) No Owner shall cause or permit anything to be placed on the Common Elements immediately surrounding the Unit. No sign, awning, canopy, window air conditioning unit, shutter, or other fixture shall be affixed to or placed upon the exterior walls or roof of the building, or any part of the Common Elements, without the prior written consent of the Board of Directors of the Association.

(h) No satellite dishes over one (1) meter shall be allowed on the Condominium Property at any time. Satellite dishes less than one (1) meter shall not be allowed on any part of the Common Elements of the Condominium except with the express approval of the Board of Directors as to location of the receiving equipment or dish.

(i) No clothes, sheets, blankets, laundry of any kind or other articles shall be hung out or exposed from or on any part of the Common Elements. The Common Elements shall be kept clear of rubbish, debris and other unsightly materials.

(j) No waterbed or aquarium exceeding five (5) gallons shall be placed or utilized in any Unit.

(k) Applicable building codes require that all clothes dryers installed in the Units must have specified venting characteristics. Accordingly, Unit Owners may install and replace their clothes dryers only with dryers meeting the required building code specifications.

(l) No one shall use or permit to be brought into any Unit or upon any of the Common Elements and facilities any flammable oils or fluids such as gasoline, kerosene, naphtha or benzene, or other explosives or articles deemed extra hazardous to life, limb or property, without the written consent of the Board of Directors of the Association.

(m) No animal or pet shall be kept for commercial purposes, nor be allowed to create or cause any disturbance or nuisance of any kind, and if an animal or pet does cause or create a nuisance or an unreasonable disturbance, said animal or pet shall be permanently removed from the Condominium Property within seven (7) days from the date the Owner receives written notice from the Board of Directors to remove such animal or pet. The Owner of any pet or animal shall be liable for any and all damage caused by such animal or pet to any part of the Condominium Property. No Owner shall keep more than two (2) domesticated cats or dogs in a Unit at any given time without prior written approval of the Board of Directors. In addition, no snakes, or animals deemed vicious or dangerous in the sole discretion of the Board may be brought onto or kept on the Condominium Property at any time. The Board shall have authority to pass and enforce Rules and Regulations regarding the keeping of pets on the Condominium Property, and charge a fee for the registration of such pet(s).

(n) No structure of a temporary character, trailer, tent, shack, carport, garage, barn or other outbuilding shall be erected by any Owner, other than the Developer, on any

portion of the Condominium Property, at any time, either temporarily or permanently, without the prior written approval of the Board.

(o) The display or discharge of firearms or fireworks on the Common Elements is prohibited; provided, however, that the display of lawful firearms on the Common Elements is permitted by law enforcement officers and also is permitted for the limited purpose of transferring firearms across the Common Elements to or from an Owner's Unit so long as the firearm is not loaded and not carried in a threatening manner. The term "firearms" includes "B-B" guns, pellet guns and other firearms of all types, regardless of size.

(p) No Owner or Occupant of the Units restricted to residential use may conduct any business, trade, garage sale, moving sale, rummage sale, or similar activity at or about the Condominium, whether within a Unit or otherwise, except that an Owner or Occupant residing in Unit may conduct business activities within the Unit so long as: (i) the existence or operation of the business activity is not apparent or detectable by sight, sound or smell from outside the Unit; (ii) the business activity conforms to all zoning and other legal requirements for the Condominium; (iii) the business activity does not, in the Board's reasonable judgment, generate any vehicular or pedestrian traffic or increase the number of vehicles being parked on the Condominium; and (iv) the business activity is consistent with the residential character of the Unit and does not constitute a nuisance, or a hazardous or offensive use, or threaten the security or safety of other residents of the Condominium, as may be determined in the sole discretion of the Board. The terms "business" and "trade", as used in this provision, shall be construed to have their ordinary, generally accepted meanings and shall include, without limitation, any occupation, work, or activity undertaken on an ongoing basis which involves the provision of goods or services to persons other than the provider's family and for which the provider receives a fee, compensation, or other form of compensation.

Section 7.03 Lease of Units. Units may be leased by the Unit Owners; provided, however, that any such lease and the rights of any tenant thereunder are hereby made expressly subject to the power of the Association to prescribe reasonable rules and regulations relating to the lease and rental of Units and to enforce the same directly against such tenant or other Occupant by the exercise of such remedies as the Board deems appropriate; provided, however, that no restrictions shall be imposed which shall have the individual or cumulative effect of prohibiting or materially impairing the rental or lease of Units. No individual rooms may be rented in the Units restricted to residential use. Further, all leases must be in writing for a term no less than _____ (__) _____, with a copy provided to the Association upon request by the Association and may be redacted to prevent sharing information related to the amount of rent. This restriction on use shall be a covenant running with each Unit, creating a burden on each single Unit and Unit Owner for the benefit of every other Unit and Unit Owner.

Notwithstanding anything contained in this Section to the contrary, each Owner shall be responsible for the actions of his tenants and nothing herein or in any such lease shall relieve an Owner of his obligations under the Condominium Documents. Each Unit Owner who has or who shall lease his Unit irrevocably empowers and authorizes the Association or its

managing agent to enforce the Rules and Regulations of the Association and to terminate the lease of and evict any tenant who fails to comply with said Rules or who provides other sufficient cause for termination of the lease and eviction in accordance with the laws of the State of Alabama, the Condominium Documents or any contract for lease. The Association, the Board or its managing agent shall not become liable to any Unit Owner or sublessor or other party for any loss of rents or other damages resulting from the reasonable exercise of the provisions of this Section. The provisions of this Section shall not be applicable to the Developer who is irrevocably empowered without any limitation at all times, whether for permanent or temporary occupancy to sell, lease or rent Units for any period and under any terms to any lessees or purchasers or transferees with the right to take any action necessary to consummate the sale or rental of said Units, including, but not limited to, the right to maintain model Units, post signs, have employees in the offices maintained in the Condominium buildings, use the Common Elements and show Units to prospective tenants. Sales and rental office signs and all items pertaining to the rental or sale of Units shall not be considered Common Elements and shall remain the property of the Developer.

Section 7.04 Right of Access. Each Unit Owner grants a right of access to his Unit to the Association, and any other person authorized by the Association for the purpose of making inspections and for the purpose of correcting any condition originating in his Unit and threatening other Units or Common Elements or for the purpose of performing installations, alterations or repairs to the mechanical or electrical services or other Common Elements on his Unit, if any, or to correct any condition which violates the provisions of any Mortgage covering another Unit, or to enforce any provision of the Condominium Documents, provided that requests for entry are made in advance and that such entry is at a time reasonably convenient to the Unit Owner. In case of an emergency, such right of entry shall be immediate whether the Unit Owner is present at the time or not. To the extent that damages are inflicted on the Common Elements or any Unit through which access is taken, the Unit Owner or the Association, if it caused the same, shall be liable for the prompt repair thereof. Access codes, remotes, or other security passwords shall not be provided to any person other than the Unit Owner, an Occupant under an approved lease, and the Association's management company.

Section 7.05 Limitation of Liability. The Association shall not be liable for any failure of water or power supply, telephone, security, fire protection or other service to be obtained by the Association or paid for out of the Common Expense funds, for problems resulting from the operation or lack of operation of sewer lines servicing the Condominium Property, or for injury or damage to a person or property caused by the natural elements or resulting from electricity, water, snow or ice which may leak or flow from any portion of the Common Elements or from any wire, pipe, drain, conduit, appliance or equipment. The Association shall not be liable to the Owner of any Unit for loss or damage, by theft or otherwise, of articles which may be stored upon any of the Common Elements. No diminution or abatement of the Common Expense assessments, as herein elsewhere provided, shall be claimed or allowed for inconvenience or discomfort arising from the making of repairs or improvements to the Common Elements or to any Unit, or from any action taken by the Association to comply with any law or ordinance or with the order or directive of any municipal or other governmental or judicial authority or for the dispossession of the Unit Owner by reason of fire or other casualty, except to the extent covered by insurance.

Section 7.06 Abatement of Violations. The violation of any Rule or Regulation adopted by the Board of Directors of the Association or breach of the provisions of the Condominium Documents, shall give the Developer, the Association or any Unit Owner the right, in addition to any other right or remedy elsewhere available, to enjoin, abate or remedy by appropriate legal proceedings, either at law or in equity, the continuance of any such breach. All expenses of such actions or proceedings against a defaulting Unit Owner, including court costs, attorney's fees and other fees and expenses, and all damages, liquidated or otherwise, together with interest thereon at the highest lawful rate on judgments until paid, shall be charged to and assessed against such defaulting Owner, and the Association shall have a lien for all of the same upon the Unit of such defaulting Owner, upon all of his additions and improvements thereto and a security interest under the Alabama Uniform Commercial Code upon all of his personal property in his Unit or located elsewhere on the Condominium Property. Nothing herein contained shall prevent an Owner from maintaining such an action or proceeding against the Association and the expense of any action to remedy a default of the Association shall be a Common Expense if a court of competent jurisdiction finds the Association to be in default as alleged in such action or proceeding.

Section 7.07 Failure of the Association to Insist on Strict Performance; No Waiver. Failure of the Association to insist in any one or more instances upon the strict performance of any of the terms, covenants, conditions or restrictions of this Declaration, or to exercise any right or option herein contained, or to serve any notice or to institute any action shall not be construed as a waiver or a relinquishment from the future performance of such term, covenant, condition or restriction but such term, covenant, condition or restriction shall remain in full force and effect. The receipt by the Association of any assessment from an Owner with knowledge of the breach of any covenant hereof shall not be deemed to be a waiver of such breach and no waiver by the Association of any provision hereof shall be deemed to have been made unless expressed in writing and signed by the Board of Directors of the Association.

ARTICLE VIII

RIGHTS OF MORTGAGEES

Section 8.01 Notification of Mortgagees Required. Any Mortgagee shall have the right to be given written notification by the Association of (a) any sixty (60) day default by the Owner of the Unit covered by the Mortgage in the payment of assessments or in any other provision of the Condominium Documents; (b) any loss to or taking of the Common Elements or Limited Common Elements if such loss or taking exceeds \$10,000; (c) damage to a Unit covered by the Mortgage if the amount of such damage exceeds \$10,000; (d) any condemnation of all or a portion of the Condominium Property; (e) a lapse or cancellation or material modification of any insurance policy or fidelity bond maintained by the Association; and (f) any proposed action that requires the consent of a specified percentage of Mortgagees if such Mortgagee has given notice to the Association of its interest in the Condominium.

Section 8.02 Right of Inspection. Mortgagees shall have the right to examine the books and records of the Association or the Condominium Property during normal business hours and to receive annual reports, other financial data, and, upon request, an annual audited

statement, within one hundred twenty (120) days following the end of any fiscal year of the Association. If a Mortgagee requests an annual audited statement, the Mortgagee and the Association shall share equally the cost of the audit.

Section 8.03 Priority of Mortgagees.

(a) Any lien which is or may be created hereunder upon any Unit, including, but not limited to, the lien created for assessments under Section 5.07 hereof and the right to foreclose the same is and shall be subject and subordinate to and shall not affect the rights of the holder of the indebtedness secured by any Mortgage upon such interest made in good faith and for value and recorded prior to the creation of the lien hereunder, provided that after the foreclosure of any such Mortgage there may be a lien created pursuant to Section 5.07 hereof on the interest of the purchaser as an Owner after the date of such foreclosure sale to secure all assessments hereunder. After the date of such foreclosure sale, said lien, if any, shall be claimed and shall have the same effect and be enforced in the same manner provided herein.

Notwithstanding the above, the lien created pursuant to Section 5.07 hereof is prior to any Mortgage to the extent of the Common Expense assessments based on the annual budget which would have become due in absence of acceleration during the six (6) months immediately preceding institution of an action to enforce the lien.

(b) No provision of this Declaration, the Certificate of Formation, the Bylaws or the Rules and Regulations shall be construed to grant to any Unit Owner, or to any other party any priority over any rights of the Mortgagees of the Units pursuant to their Mortgages in the case of distribution to Unit Owners of the insurance proceeds or condemnation awards for losses or a taking of Units or the Common Elements, the Limited Common Elements or any portion thereof.

(c) As provided in the Act, all assessments, property taxes and other charges imposed by any taxing authority which may become liens prior to a Mortgage, shall be separately assessed against and collected on each Unit as a single parcel, and not on the Condominium Property as a whole.

(d) No breach of the covenants, conditions or restrictions herein contained shall defeat or render invalid the lien of any Mortgage made in good faith and for value, but all of said covenants, conditions and restrictions shall be binding upon and effective against any Owner whose title is derived through foreclosure or otherwise.

Section 8.04 Request for Protection by Mortgagees. Whenever the holder of any Mortgage desires the benefit of the provisions of Article VIII, Section 8.01 to be applicable to it, it shall serve written notice of such fact upon the Association, by registered or certified mail, addressed to the Association's registered agent, identifying the Unit upon which it holds a Mortgage or identifying any Units owned by it, together with sufficient pertinent facts to identify any Mortgage which may be held by it. Said notice shall designate the place to which the notices are to be given by the Association to such Mortgagee. Should the Association send notice via certified mail of any action requiring the affirmative vote of the Mortgagee, and the Mortgagee

shall not respond within sixty (60) days from notice of such right, the Mortgagee shall be deemed to have given its implied consent to such action.

ARTICLE IX

CASUALTY LOSS AND INSURANCE

Section 9.01 Responsibility of Owners; Separate Insurance Coverage.

(a) The Owner of each Unit may, at his or her expense, obtain insurance coverage for loss of or damage to any furniture, furnishings, personal effects, and other property belonging to such Owner, and shall, at his or her expense, obtain insurance coverage against personal liability for injury or damage to the person or property of another while within such Owner's Unit or upon the Common Elements or Limited Common Elements in an amount not less than \$1,000,000.00. If a Unit Owner leases his Unit, such insurance shall cover any act by any Occupant. Risk of loss of or damage to any furniture, furnishings and personal property belonging to or carried on the person of the Owner, or which may be stored in any Unit, or in or upon Common Elements or Limited Common Elements, shall be borne by the Owner of each Unit. All furniture, furnishings and personal property constituting a portion of the Common Elements or Limited Common Elements and held for the joint use and benefit of all Owners of Units shall be covered by such insurance as shall be maintained in force and effect by the Association as hereinafter provided. Each Owner shall be required to notify the Association of all improvements made by the Owner to his Unit, the value of which is in excess of \$10,000. All insurance obtained by the Owner of each Unit shall, whenever such provisions shall be available, provide that the insurer waives its right of subrogation as to any claims against other Owners, the Association or Developer, and their respective servants, agents, employees and guests.

(b) Any Owner who obtains an individual insurance policy covering any portion of the Condominium Property other than personal property belonging to such Owner shall be required to file a copy of such individual policy or policies with the Association within thirty (30) days after the purchase of such insurance. In the event casualty insurance maintained by an Owner causes a decrease in the amount of the insurance coverage maintained by the Association for the benefit of all Owners on a casualty loss to the Condominium Property by reason of proration or otherwise, the Owner so maintaining such insurance shall be deemed to have assigned to the Association the proceeds collected on such policy for loss or damage to the Condominium Property and such proceeds shall be paid directly to the Association by the insurer. Any such insurance proceeds shall be applied and distributed by the Association in accordance with this Article IX.

Section 9.02 Insurance to be Maintained by the Association.

(a) Hazard Insurance. The Association shall obtain and maintain at all times a policy or policies of multi-peril type hazard insurance, including insurance for such other

risks of a similar or dissimilar nature, as are or shall hereafter customarily be covered with respect to other condominium projects similar in construction, design and use, insuring the Condominium Property against loss or damage by the perils of fire, lightning and those perils contained in extended coverage, vandalism and malicious mischief endorsements, and if the Condominium Property is located in an area identified by the Secretary of Housing and Urban Development as having special flood hazards, the Board shall, to the extent obtainable, insure the insurable property included in the Condominium Property against the perils of flood under the National Flood Insurance Act of 1968 and acts amendatory thereto. The amount of insurance coverage shall be determined on a replacement cost basis in an amount not less than one hundred percent (100%) of the then current replacement cost of the improvements which constitute the Condominium Property, including the Common Elements, Limited Common Elements and the Unit as purchased by the Unit Owner (but excluding land, foundations, excavations and other items usually excluded from such insurance coverage). Such insurance coverage shall be written in the name of, and the proceeds thereof shall be payable to, the Association or the Insurance Trustee (hereinafter defined), as trustee for the use and benefit of the individual Owners (without naming them) in the proportionate shares equal to their respective percentage ownership of the Common Elements. Periodically, prior to the renewal of any such policy or policies of insurance, the Association should obtain an opinion or an appraisal from a qualified appraiser for the purpose of determining the full replacement cost of the Common Elements, the Limited Common Elements and the Units for the amount of insurance to be obtained pursuant hereto. The cost of any such opinion or appraisal shall be a Common Expense. All such policies of insurance shall comply with the provisions of Section 9.03 hereof and shall (i) contain standard mortgagee clause endorsements in favor of the Mortgagee or Mortgagees of each Unit, if any, as their respective interest may appear; and (ii) provide that the insurance shall not be invalidated by any act or neglect of any Owner.

(b) Public Liability and Property Damage Insurance. The Association shall obtain and maintain at all times a comprehensive policy or policies of public liability and property damage insurance in such amount (but not less than \$1,000,000) and in such form as shall be required by the Association to protect said Association and the Owners of all Units which provide coverage for bodily injury and property damage resulting from the operation, maintenance or use of the Common Elements and Limited Common Elements and for legal liability resulting from employment contracts to which the Association is a party.

(c) Workmen's Compensation Insurance. If required by the laws of the State of Alabama, the Association shall obtain and maintain at all times a policy or policies of workmen's compensation insurance to meet the requirements of the laws of the State of Alabama.

(d) Fidelity Bonds. The Association may obtain and maintain fidelity bonds for any person who either handles or is responsible for funds held or administered by the Association naming the Association as the obligee. The amount of the fidelity bond should cover the maximum funds that will be in the custody of the Association, but not less than

the sum of three (3) months' assessments on all Units plus the reserve funds of the Association.

(e) Directors and Officers Liability Insurance. The Association may maintain Directors and Officers liability insurance in an amount to be determined by the Board of Directors.

(f) Other Insurance. The Association shall obtain and maintain such other insurance coverage as the Board of Directors of the Association, in its sole discretion, may determine from time to time to be in the best interest of the Association and the Owners of all Units.

Section 9.03 Governing Provisions. All insurance obtained and maintained by the Association as provided in Section 9.02 above shall be governed by the following provisions:

(a) All policies shall (i) comply with the hazard and casualty insurance requirements of the Federal Home Loan Mortgage Corporation and the Federal National Mortgage Association as they shall apply to condominium loans; and (ii) be written with a company licensed to do business in the State of Alabama and holding a financial rating of Class V or better and a general policyholders rating of "A" or better by Best's Insurance Reports or other then comparable rating. To the extent that the provisions of this Declaration with respect to the maintenance of insurance shall conflict with the hazard and casualty insurance requirements of the Federal Home Loan Mortgage Corporation or the Federal National Mortgage Association, then the requirements of the Federal Home Loan Mortgage Corporation and the Federal National Mortgage Association shall control and such requirements shall be complied with by the Association.

(b) Exclusive authority to adjust all claims under the policies hereafter in force on the Condominium Property shall be vested in the Association or its authorized representatives.

(c) In no event shall the insurance coverage obtained and maintained by the Association hereunder be brought into contribution with the insurance purchased by the individual Owners or their Mortgagees.

(d) The Association shall be required to make every effort to secure insurance policies that will provide for the following:

(i) A waiver of subrogation by the insurer as to any claims against the Association, the Board of Directors, the Developer or the Owners;

(ii) An agreement by the insurer that the insurance coverage cannot be terminated or materially changed without thirty (30) days prior written notice to the Association and the Mortgagee of each Unit;

(iii) The insurance coverage will be primary, even if a Unit Owner has other insurance that covers the same loss; and

(iv) No act or omission by any Unit Owner, unless acting within the scope of his authority on behalf of the Association, will void the policy or be a condition to recovery under the policy.

Section 9.04 Premiums and Deductibles. Premiums for insurance policies purchased by the Association shall be paid by the Association as a Common Expense; except that the amount of increase over the usual premium occasioned by the use, misuse, occupancy or abandonment of a Unit or its appurtenances or of the Common Elements or Limited Common Elements by an Owner shall be assessed against that Owner. Any deductible incurred by reason of a loss or claim under any insurance policy purchased under this Article IX shall be paid by the Association, unless such loss or claim was caused by a Unit Owner or Occupant, family member, lessee, guest or invitee thereof, resulted from the use, misuse, occupancy, negligence or abandonment of a Unit or any portion thereof, or the cause arose from the Owner's Unit even through no fault of the Unit Owner. In such event the Unit Owner from whose Unit the cause originated, will be responsible for the deductible under the Association's insurance policy, which may be assessed against that Unit Owner as a special assessment.

Section 9.05 Insurance Trustee. The Association may engage the services of a bank or trust company authorized to do trust business in the State of Alabama and having a capital and surplus of not less than \$50,000,000 to act on its behalf as an insurance trustee ("Insurance Trustee") and to receive and disburse the insurance proceeds in accordance with the provisions of this Declaration. In the event the lowest of two bids from reputable contractors for making all repairs required by any such loss shall exceed \$50,000, the Association upon written demand of the Mortgagee or Owner of any Unit shall engage the services of a bank or trust company to act as Insurance Trustee as aforesaid. The Association, as a Common Expense, shall pay a reasonable fee to said Insurance Trustee for its services rendered hereunder, and shall pay such costs and expenses as said Insurance Trustee may incur in the performance of any duties and obligations imposed upon it hereunder. Said Insurance Trustee shall be liable only for its willful misconduct, bad faith or gross negligence, and then for only such money which comes into the possession of said Insurance Trustee. Whenever the Insurance Trustee may be required to make distribution of insurance proceeds to Owners of Units and their Mortgagees, as their respective interests may appear, or to any other party for repair, replacement or reconstruction of property, the Insurance Trustee may rely upon a certificate of the President and Secretary of the Association, executed under oath, which certificate will be provided to said Insurance Trustee upon request made to the Association. Such certificate is to certify unto said Insurance Trustee the name of the Owner of each Unit, the name of the Mortgagee who may hold a Mortgage encumbering each Unit, and the respective percentages of any distribution which may be required to be made to the Owner of any Unit, and his respective Mortgagee, as their respective interests may appear, or to certify the name of the party to whom payments are to be made for repair, replacement or reconstruction of all or a portion of the Condominium Property. The rights of the Mortgagee of any Unit under any standard mortgage clause endorsement to such policy shall, notwithstanding anything to the contrary therein or in any Mortgage contained, at all times be subject to the provisions hereof with respect to the application of insurance proceeds to reconstruction of the damaged Condominium Property; provided, however, that if the Association or the Insurance Trustee fails to perform all the conditions precedent required by the policy or policies of insurance, and fails to collect the amount of the loss within the time required by law, and the Mortgagee or Mortgagees are required to avail

themselves of their rights under the standard mortgage clause to collect the proceeds of the policy or policies of insurance, any amount so collected through the efforts of said Mortgagee or Mortgagees shall be applied as directed by said Mortgagee or Mortgagees. No provision hereof shall entitle an Owner or any other party to any priority over a Mortgagee with respect to the distribution of any insurance proceeds with respect to such Unit.

Section 9.06 Loss to Common Elements Only. In the event of the loss of or damage to only Common Elements, real or personal, by reason of fire or other casualties, which loss or damage is covered by fire and casualty insurance, the proceeds paid to the Association or the Insurance Trustee, as the case may be, to cover such loss or damage shall be applied to the repair, replacement or reconstruction of such loss or damage. If the insurance proceeds are in excess of the cost of the repair, replacement or reconstruction of such Common Elements, then such excess insurance proceeds shall be paid by the Insurance Trustee to the Owners of all Units, the distribution to be separately made to the Owner of each Unit and his respective Mortgagee, as their interests may appear, in such proportion that the share of such excess insurance proceeds paid to the Owner of each Unit and his Mortgagee shall bear the same ratio to the total excess insurance proceeds as the undivided interest in the Common Elements appurtenant to each Unit bears to the total undivided interest in the Common Elements appurtenant to all Units. If there is no insurance coverage for such loss or damage, or if it appears that the insurance proceeds covering the fire or casualty loss or damage payable to the Association or the Insurance Trustee are not sufficient to pay for the repair, replacement or reconstruction of the loss or damage, or that the insurance proceeds when collected will not be so sufficient, then the Association shall pay, or shall deposit with the Insurance Trustee, as the case may be, a sum, which together with the insurance proceeds received or to be received, if any, will enable said Insurance Trustee to completely pay for the repair, replacement or reconstruction of any loss or damage, as the case may be. The monies to be so paid, or deposited by the Association with the Insurance Trustee, may be paid by the Association out of its reserve for replacement fund and if the amount in such reserve for replacement fund is not sufficient, or if the Board of Directors determines not to use such fund for said purpose, then the Association shall levy and collect an assessment against the Owners of all Units in an amount which shall provide the funds required to pay for said repair, replacement or reconstruction.

Section 9.07 Loss to Common Elements, Limited Common Elements and/or Units. In the event of loss of or damage to Common Elements, Limited Common Elements and/or any Unit by reason of fire or other casualty, which loss or damage is covered by fire and casualty insurance, the proceeds paid to the Association or Insurance Trustee, as the case may be, to cover such loss or damage, shall be first applied to the repair, replacement or reconstruction of the Common Elements, then to the repair, replacement or reconstruction of the Limited Common Elements and any remaining insurance proceeds shall be applied to the repair, replacement or reconstruction of any Unit which may have sustained any loss or damage so covered. If the insurance proceeds are in excess of the cost of the repair, replacement or reconstruction of the Common Elements, the Limited Common Elements and the Units sustaining any loss or damage, then such excess insurance proceeds shall be paid and distributed by the Insurance Trustee to the Owners of all Units, and to their Mortgagees, as their respective interests may appear. Such distributions are to be made in the manner and in the proportions as are provided for the distribution of insurance proceeds under Section 9.06 above. If there is no insurance coverage for such loss or

damage, or if it appears that the insurance proceeds covering the fire and casualty loss or damage payable to the Association or the Insurance Trustee, as the case may be, are not sufficient to pay for the repair, replacement or reconstruction of the loss or damage, or that the insurance proceeds when collected will not be sufficient, then the Board of Directors of the Association shall, based on reliable and detailed estimates obtained by it from competent and qualified parties, determine and allocate the cost of repair, replacement or reconstruction among the Common Elements, the Limited Common Elements and the Units sustaining any loss or damage. If the proceeds of said fire or casualty insurance, if any, are sufficient to pay for the repair, replacement or reconstruction of any loss of or damage to the Common Elements and Limited Common Elements, but are not sufficient to repair, replace or reconstruct any loss of or damage to the Units sustaining damage, then the Association shall levy and collect an assessment from the respective Owners of the Units sustaining any loss or damage, and the assessment so collected from said Owners shall be deposited with the Insurance Trustee, so that the sum on deposit with said Insurance Trustee shall be sufficient to completely pay for the repair, replacement or reconstruction of all Common Elements, Limited Common Elements, and Units. In said latter event, the assessment to be levied and collected from the Owners of the Units shall be apportioned among such Owners in such manner that the assessment levied against each Owner of a Unit shall bear the same proportion to the total assessment levied against all of said Owners of Units sustaining loss or damage as the cost of repair, replacement or reconstruction of each Owner's Unit bears to the cost applicable to all of said Units sustaining loss or damage. If the fire or casualty insurance proceeds, if any, payable to the Association or the Insurance Trustee are not an amount which will pay for the complete repair, replacement or reconstruction of the Common Elements and Limited Common Elements, it being recognized that such insurance proceeds are to be first applied to the payment for repair, replacement or reconstruction of said Common Elements and Limited Common Elements before being applied to the repair, replacement or reconstruction of any Unit sustaining loss or damage, then the cost to repair, replace, or reconstruct said Common Elements and Limited Common Elements in excess of available fire and casualty insurance proceeds shall be levied and collected as an assessment from the Owners of all Units in the same manner as would be levied and collected had the loss or damage sustained been solely to the Common Elements and Limited Common Elements and the fire or casualty insurance proceeds had been insufficient to cover the cost of repair, replacement or reconstruction. The cost of repair, replacement or reconstruction of each Unit sustaining loss or damage shall then be levied and collected by assessment against the Owners of the Units sustaining the loss or damage in the same manner as is above provided for the apportionment of such assessment between Owners of any Units sustaining loss or damage.

Section 9.08 Estimates of Repair; Plans and Specifications; Payment of Assessments. In the event of loss or damage to Condominium Property for which there is complete or partial insurance coverage, the Association shall promptly repair or replace those portions of the Condominium Property for which the Association is required to obtain insurance coverage unless (i) the Condominium is terminated, or (ii) eighty percent (80%) of the Unit Owners, including every Owner of a Unit which Unit or appurtenant Limited Common Element will not be rebuilt, vote not to rebuild. The Association shall be appointed as attorney-in-fact for each Unit Owner for the purpose of representing the Unit Owners in any proceeding, negotiation, settlement, or agreement arising from any loss or damage to the Condominium Property. Whenever it shall appear that the insurance proceeds payable for such loss or damage will not be sufficient to defray the cost of repair, replacement or reconstruction thereof, the additional money

required to completely pay for such repair, replacement or reconstruction of said loss or damage whether to be paid by all of the Owners of Units or only by the Owners of Units sustaining loss or damage, or both, as herein provided, shall be paid to the Association and deposited with the Insurance Trustee, if any, not later than thirty (30) days from the date on which the Association or the Insurance Trustee, as the case may be, shall receive the monies payable from the policies of fire and casualty insurance.

ARTICLE X

CONDEMNATION

Section 10.01 Condemnation Considered a Casualty Loss. The taking of a portion of a Unit, the Common Elements or the Limited Common Elements by eminent domain shall be deemed to be a casualty loss, and except as otherwise provided in Section 10.02 below, the awards for such taking shall be deemed to be proceeds from insurance on account of the casualty and shall be applied and distributed by the Association in accordance with the provisions of Article IX. Even though the awards may be payable to the Owners, the Owners shall deposit the awards with the Association or Insurance Trustee, as the case may be; and in the event of failure to do so, in the discretion of the Board of Directors of the Association, a special assessment shall be made against a defaulting Owner in the amount of his award, or the amount of such award shall be set off against the sums hereinafter made payable to such Owner. If any Unit or portion thereof is made the subject matter of any condemnation or eminent domain proceeding or is otherwise sought to be acquired by a condemning authority, the Mortgagee of such Unit shall be entitled to timely written notice of any such proceeding or proposed acquisition as provided in Section 8.01, and no provision hereof shall entitle the Owner of such Unit or other party to priority over such Mortgagee with respect to the distribution of any award or settlement to the Owner of the Unit.

Section 10.02 Partial Condemnation. In the event that the Condominium Property is not to be terminated and one or more Units are taken in part, the taking shall have the following effects:

(a) If the taking reduces the size of a Unit and the remaining portion of that Unit can be made tenantable, the award for the taking for a portion of the Unit shall be used for the following purposes in the order stated, and the following changes shall be effected in the Condominium Property:

(i) The Unit shall be made tenantable and if the cost of such work exceeds the amount of the award, the additional funds shall be assessed against the Owner of the Unit.

(ii) The balance of the award, if any, shall be distributed to the Owner of the Unit and the Mortgagee of the Unit, as their respective interests may appear.

(iii) If there is a balance of the award distributed to the Owner and the Mortgagee, the share of the Common Elements or Limited Common Elements, if any, appurtenant to the Unit shall be equitably reduced. This shall be done by

reducing such share by the proportion which the balance of the award so distributed bears to the market value of the Unit immediately prior to the taking, and then recomputing the shares of all Owners in the Common Elements and the Owners of all Limited Common Elements as percentages of the total of their shares as reduced by the taking.

(b) If the taking destroys or so reduces the size of a Unit so that it may not be made tenantable, the award for the taking of the Unit shall be used for the following purposes in the order stated, and the following changes shall be effected in the Condominium Property:

(i) The market value of such Unit immediately prior to the taking, shall be paid to the Owner of the Unit and to each Mortgagee of the Unit, as their respective interests may appear.

(ii) The remaining portion of such Unit, if any, shall become a part of the Common Elements and shall be placed in condition for use by all of the Owners, in the manner approved by the Board of Directors of the Association; provided, however, that if the cost of such work shall exceed the balance of the fund from the award for the taking, such work shall be approved in the manner required for further improvement of the Common Elements under Section 6.04 above.

(iii) The shares in the Common Elements and Limited Common Elements appurtenant to the Units which continue as a part of the Condominium Property shall be equitably adjusted to distribute the ownership to the Common Elements among the reduced number of Owners. This shall be done by recomputing the shares of such continuing Owners in the Common Elements as percentages of the total of the shares of such Owners as they exist prior to the adjustment.

(iv) If the amount of the award for taking is not sufficient to pay the market value of the condemned Unit to the Owner and to restore the remaining portion of the Unit in condition for use as a part of the Common Elements, the additional funds required for such purposes shall be raised by assessments against all of the Owners who will continue as Owners of the Units after the changes in the Condominium Property affected by the taking. Such assessment shall be made in proportion to the share of such Owners in the Common Elements after the changes affected by the taking.

(c) If the market value of a Unit prior to the taking cannot be determined by agreement between the Owner and the Mortgagee and the Association within thirty (30) days after notice by any such party that agreement cannot be reached, such value shall be determined by three independent qualified appraisers with one appraiser to be selected by the Association, one appraiser to be selected by the Owner and Mortgagee, and the third appraiser to be selected by the two appraisers so appointed, and the fair market value of the Unit shall be deemed to be the average of the two appraisals of the fair market value of the Unit made by said appraisers having the least difference in amount. The cost of such

appraisal shall be assessed against all Owners in the shares of the Owners in the Common Elements as they existed prior to the changes affected by the taking.

(d) Changes in the Units, in the ownership of the Common Elements and Limited Common Elements, and in the share of liability for Common Expenses and Limited Common Expenses which are affected by eminent domain, shall be evidenced by an amendment of this Declaration which needs be approved only by a majority of the Board of Directors of the Association.

Section 10.03 Association Appointed As Attorney-In-Fact for Unit Owners.

The Association shall be appointed as attorney-in-fact for each Unit Owner for the purpose of representing such Unit Owners in any proceeding, negotiation, settlement or agreement arising from the condemnation or taking by eminent domain of the Condominium Property or any portion thereof.

ARTICLE XI

TERMINATION

Section 11.01 Termination by Consent. Except in the event of a condemnation of all Units by eminent domain, this Declaration and plan of condominium ownership established herein may only otherwise be terminated by the consent of the Owners of Units to which at least eighty (80%) of the votes in the Association are allocated and sixty-seven percent (67%) of the votes of all Mortgagees, in which event the termination of the Condominium shall be by such plans as may be then adopted by at least eighty (80%) percent of the votes in the Association and sixty-seven (67%) percent of the votes of the Mortgagees. Such election to terminate this Declaration and the plan of condominium ownership established herein shall be evidenced by a termination agreement executed in writing by all of the aforesaid parties in recordable form, and such instrument shall be recorded in the Probate Office. Any termination agreement and the ownership of the property which constituted the Condominium Property and all other assets of the Association shall be subject to Section 35-8A-218 of the Act.

Section 11.02 The Association Appointed as Attorney-In-Fact for Unit Owners. The Association shall be appointed as attorney-in-fact for each Unit Owner for the purpose of representing such Unit Owners in any proceeding, negotiation, settlement or agreement arising from the termination of this Declaration and plan of condominium ownership established herein.

ARTICLE XII

CONTROL OF THE ASSOCIATION

Section 12.01 Election of Board of Directors. Developer may control by appointing and removing officers and members of the Board until the earlier of (a) sixty (60) days have elapsed since seventy-five percent (75%) of the Units in the Condominium which may ever be created have been conveyed to purchasers of Units other than the Developer, (b) two (2) years

have elapsed since Developer has ceased offering Units in the Condominium for sale in the ordinary course of business, or (c) the Developer elects, at its option, to terminate control of the Association, whichever first occurs. Not later than ninety (90) days after conveyance of twenty-five percent (25%) of the Units which may ever be created to Unit Owners other than the Developer, the Unit Owners other than Developer shall be entitled to elect one member or twenty-five percent (25%) of the members of the Board. Not later than ninety (90) days after conveyance of fifty percent (50%) of the Units which may ever be created to Unit Owners other than Developer, not less than thirty-three and one-third percent (33 $\frac{1}{3}$ %) of the members of the Board may be elected by the Unit Owners. Within sixty (60) days of the date of termination of control of the Association by the Developer, the Board of Directors shall call and give not less than ten (10), nor more than thirty (30), days' notice of a special meeting of the membership for the purpose of electing the members of the Board of Directors.

Section 12.02 Notice of Meeting. Within sixty (60) days before the date of termination of control of the Association by the Developer, the Association shall call and give not less than ten (10) days nor more than thirty (30) days' notice of a meeting of the Unit Owners for the purpose of electing the members of the Board of Directors of the Association. Such meeting shall be called and the notice given in accordance with the Bylaws.

Section 12.03 Status of Unsold Units.

(a) Developer shall be deemed to be the Owner of each Unit which has not been conveyed to a person other than the Developer. Unless otherwise provided in the Condominium Documents, the Developer shall be entitled to all rights and privileges available to, and shall be subject to any and all obligations and duties imposed upon, the Owner of any such Unit under the Condominium Documents.

(b) Any person having a first mortgage lien against any Unit which has not been conveyed to a person other than Developer, whether under a blanket mortgage affecting the Condominium Property generally or under a mortgage on one or more specific Units, shall be deemed to be a Mortgagee with respect to any such Unit, and shall be entitled to all rights and privileges available to a Mortgagee of any such Unit under the Condominium Documents so long as the Mortgagee has given notice to the Association that it is a Mortgagee.

(c) During the first year of operation of the Association, the Association may modify the initial operating budget to account for items under warranty, less than full occupancy and all other startup cost savings. The working capital fund deposit of an amount equal to three (3) months assessment shall be based on the full estimated operating budget, however. Notwithstanding the provisions of Sections 4.02 and 12.03 (a) above, no assessments shall be imposed by the Association against the Developer as the Owner of unsold Units until sixty (60) days after the conveyance of the first Unit. During such period, Developer shall be responsible for the Common Expenses and Limited Common Expenses of the Condominium Property, except that the Developer shall be entitled to use and apply to the payment of such Common Expenses and Limited Common Expenses any and all assessments made against the Unit Owners other than Developer and collected by

the Association for Common Expenses and Limited Common Expenses, including the assessments paid by each Owner at closing as working capital.

Section 12.04 Professional Management and Other Contracts. Any management contract, employment contract or lease of recreational facilities or any agreement between the Association and an affiliate of the Developer entered into by the Association prior to the passage of control of the Association from the Developer pursuant to Section 12.01 above shall provide the following:

(a) The Association shall have the right of termination which is exercisable without penalty any time upon not more than ninety (90) days' written notice to the other party thereto; and

(b) The Association shall have a right of termination for cause which is exercisable without penalty at any time upon not more than thirty (30) days' written notice to the other party thereto.

ARTICLE XIII

AMENDMENT

Section 13.01 Amendment. The Declaration may be amended in the following manner:

(a) Developer.

(i) The Developer reserves the right to amend the Bylaws of the Association until such time as Developer relinquishes control of the Association as provided in Section 12.01.

(ii) The Developer reserves the right to amend the Declaration for any reason so long as there is no Unit Owner other than the Developer.

(iii) The Developer reserves the right at any time to amend the Declaration without the consent of other Owners if required by any Mortgagee as a condition of making a loan secured by an interest in a Unit in order to meet the requirements of the Federal Home Loan Mortgage Corporation or the Federal National Mortgage Association; provided, that any such changes or amendments requested by a Mortgagee shall not materially affect the rights of the Unit Owners or the value of the Condominium Unit or the undivided interest in the Common Elements or Limited Common Elements, if any, attributable to each Unit Owner.

(iv) The Developer reserves the right to amend the Declaration to exercise any and all development rights and/or special declarant rights set forth in the Declaration, and to make Limited Common Element assignments or reassignments or to correct any scrivener's errors in the Declaration.

(b) At such time as there is a Unit Owner other than the Developer, then, in addition to the amendments permitted under Paragraph (a) above, the Declaration may be amended in the following manner:

(i) A proposal to amend the Declaration may be considered at any meeting of the members of the Association called for that purpose in accordance with the provisions of the Bylaws; provided that the Association provides prior written notice of such meeting to the Mortgagees as provided in Section 8.01 of the Declaration. The proposal to amend the Declaration must be approved by the affirmative vote of the members representing not less than sixty-seven percent (67%) of the total allocated votes of the Association and by the affirmative vote of the Mortgagees representing fifty-one percent (51%) of the total allocated votes of the Units subject to Mortgages.

(ii) Notwithstanding the foregoing, no amendment to the Declaration shall:

(A) change a Unit, including the ownership in Common Elements, responsibility for Common Expenses and voting rights, without the prior written approval of the Unit Owner or Unit Owners so affected and prior written approval of the holders of record of any mortgage or other liens on the Unit or Units so affected unless amended pursuant to Developer's right to create additional Units; or

(B) change, impair or prejudice the rights of Developer or change the provisions of this Declaration with respect to the Developer's rights hereunder without Developer's prior written approval.

Section 13.02 Effectiveness of Amendments. A copy of each amendment adopted pursuant to Section 13.01(a) above need only be signed by the Developer and shall be effective when recorded in the Probate Office. A copy of each amendment adopted shall be certified by the President or a Vice President and Secretary of the Association as having been duly adopted, and shall be effective when recorded in the Probate Office.

ARTICLE XIV

DISPUTE RESOLUTION

Section 14.01 Agreement to Resolve Disputes Without Litigation.

(a) Developer, the Association and its officers, directors, and committee members, all Owners, all persons subject to this Declaration, and any person not otherwise subject to this Declaration who agrees to submit to this Article (collectively, "Bound Party"), agree that it is in the best interest of all concerned to resolve disputes involving the Condominium, the Association and/or the Owners without the emotional and financial costs of litigation. Accordingly, each Bound Party agrees not to file suit in any court with

respect to a Claim (hereinafter defined), and to submit such Claim to the alternative dispute resolution procedures set forth in Section 14.02 in a good faith effort to resolve such Claim.

(b) As used in this Article, the term “Claim” shall refer to any claim, grievance or dispute arising out of or relating to:

- (i) the interpretation, application, or enforcement of the Condominium Documents;
- (ii) the rights, obligations and duties of any Bound Party under the Condominium Documents or related argument; or
- (iii) the construction of the Condominium Property;

except that the following shall not be considered “Claims” unless all parties to the matter otherwise agree to submit the matter to the procedures set forth in Section 14.02:

- (iv) any suit by the Association to collect Assessments or other amounts due from any Owner;
- (v) any suit by the Association to obtain a temporary restraining order (or emergency equitable relief) and such ancillary relief as the court may deem necessary in order to maintain the status quo and preserve the Association’s ability to enforce the provisions of this Declaration;
- (vi) any suit between Owners, which does not include Developer or the Association as a party, if such suit asserts a Claim which would constitute a cause of action independent of the Condominium Documents;
- (vii) any suit in which any indispensable party is not a Bound Party except the construction contractor or sales contractor or Condominium architect.
- (viii) any suit as to which any applicable statute of limitations would expire within one hundred eighty (180) days of giving the Notice required by Section 14.02(a), unless the party or parties against whom the Claim is made agree to toll the statute of limitations as to such Claim for such period as may reasonably be necessary to comply with this Article.

Section 14.02 Dispute Resolution Procedures.

(a) Notice. The Bound Party asserting a Claim (“Claimant”) against another Bound Party (“Respondent”) shall give written notice (“Notice”) to each Respondent and to the Board stating plainly and concisely:

- (i) the nature of the Claim, including the persons involved and the Respondent’s role in the Claim;

(ii) the legal basis of the Claim (i.e., the specific authority out of which the Claim arises);

(iii) the Claimant's proposed resolution or remedy; and

(iv) the Claimant's desire to meet with the Respondent to discuss in good faith ways to resolve the Claim.

(b) Negotiation. The Claimant and Respondent shall make every reasonable effort to meet in person and confer for the purpose of resolving the Claim by good faith negotiation. If requested in writing, accompanied by a copy of the Notice, the Board may appoint a representative to assist the parties in negotiating a resolution of the Claim.

(c) Mediation. If the parties have not resolved the Claim through negotiation within thirty (30) days of the date of the Notice described in Section 14.02(a) (or within such other period as the parties may agree upon), the Claimant shall have thirty (30) additional days to submit the Claim to mediation with an entity designated by the Association (if the Association is not a party to the Claim) or to an independent agency or individual providing dispute resolution services in the State of Alabama selected by both sides if the Association is a party. If the Claimant does not submit the Claim to mediation within such time, or does not appear for the mediation when scheduled, the Claimant shall be deemed to have waived the Claim, and the Respondent shall be relieved of any and all liability to the Claimant (but not third parties) on account of such Claim. If the parties do not settle the Claim within thirty (30) days after submission of the matter to mediation, or within such time as determined reasonable by the mediator, the mediator shall issue a notice of termination of the mediation proceedings indicating that the parties are at an impasse and the date that mediation was terminated. The Claimant shall thereafter be required to initiate arbitration proceedings on the Claim, as set forth in Section 14.02(e) below. Each party shall bear its own costs of the mediation, including attorneys' fees, and each party shall share equally all fees charged by the mediator.

(d) Settlement. Any settlement of the Claim through negotiation or mediation shall be documented in writing and signed by the parties. If any party thereafter fails to abide by the terms of such agreement, then any other party may file suit or initiate administrative proceedings to enforce such agreement without the need to again comply with the procedures set forth in this Section. In such event, the party taking action to enforce the agreement or award shall, upon prevailing, be entitled to recover from the non-complying party (or if more than one non-complying party, from all such parties in equal proportions) all costs incurred in enforcing such agreement or award, including, without limitation, attorneys' fees and court costs.

(e) **Arbitration; No Trial by Jury**. All Claims, Disputes regarding Alleged Defects or other matters in question arising out of, or relating in any way to the Condominium or the breach of and contract between the Bound Parties that are not resolved by negotiation or mediation shall be resolved by binding arbitration by a single arbitrator in Jefferson County, Alabama in accordance with the Commercial Arbitration Rules of the American Arbitration Association then in effect.

EACH PARTY ACKNOWLEDGES THAT HE OR SHE IS KNOWINGLY WAIVING THE RIGHT TO A TRIAL BY JURY RELATING TO ALL CLAIMS.

All disputes concerning the arbitrability of any Claim or the enforceability or scope of this provision shall be subject to the same binding arbitration. The parties shall bear equally the cost of the arbitrator, and each party shall otherwise bear their own costs; provided, the arbitrator shall have the authority to award costs as a part of this award to the prevailing party. The arbitrator shall follow the law applicable to any Claim and shall be empowered to award any damages or other relief which would be available under the law applicable to any such Claim. In no event shall the demand for arbitration be made after the date when institution of legal or equitable proceedings based on such claim, dispute or other matter in question would be barred by the applicable statute of limitations. The determination of the arbitrator shall be final, binding on the parties, and non-appealable and may be entered in any court of competent jurisdiction to enforce it. The parties acknowledge and agree that the transactions contemplated by, and relating to, the Condominium, which may include the use of materials and components which are obtained from out-of-state and which otherwise include the use of interstate mails, roadways and commerce, involve interstate commerce, as that term is defined in the Federal Arbitration Act, 9 U.S.C. § 2.

Section 14.03 Initiation of Litigation by Association. In addition to compliance with the foregoing alternative dispute resolution procedures, if applicable, the Association shall not initiate any judicial or administrative proceedings, or arbitration unless first approved by a vote of the members entitled to cast sixty-six and two-thirds percent (66.67%) of the votes in the Association, except that no such approval shall be required for actions or proceedings:

- (a) initiated during the period that the Developer controls the Association;
- (b) initiated to enforce the provisions of this Declaration, including collection of assessments and foreclosure of liens;
- (c) initiated to challenge property taxation or condemnation proceedings;
- (d) initiated against any contractor, vendor, or supplier of goods or services arising out of a contract for services or supplies; or
- (e) to defend claims filed against the Association or to assert counterclaims in proceedings instituted against it.

This Section 14.03 shall not be amended unless such amendment is approved by the same percentage of votes necessary to institute proceedings.

ARTICLE XV

MISCELLANEOUS

Section 15.01 Rights and Powers of Successors and Assignees. The rights and powers reserved to or exercisable by the Developer under the Condominium Documents or the Act may be exercised by any successor or assignee of the Developer (i) who acquires title from the Developer by foreclosure or other judicial sale or deed in lieu of foreclosure, or (ii) to whom the Developer specifically assigns such rights and powers in an instrument recorded in the Probate Office.

Section 15.02 Headings. The captions herein are used solely as a matter of convenience and shall not define, limit or expand any term or provision of this Declaration.

Section 15.03 Mold and Mildew; Potential for Water Intrusion. Mold and/or mildew can grow in any portion of the Condominium that is exposed to elevated levels of moisture. Each Unit Owner agrees to: (1) regularly inspect the parts of the Condominium that the Unit Owners maintain; and which are visible and accessible without having to first conduct invasive testing, for the existence of mold, mildew, and/or water intrusion and/or damage; (2) upon discovery, immediately repair in a good and workmanlike condition the source of any water intrusion in the parts of the Condominium that they respectively maintain; (3) remediate or replace any building material located in the parts of the Condominium that they maintain that has absorbed water or moisture as a result of water intrusion; and (4) promptly and regularly remediate all mold and/or mildew discovered in the parts of the Condominium that they maintain in accordance with current industry-accepted methods. In addition, each Unit Owner shall notify the Association and the Developer of the discovery of mold, mildew, and/or water intrusion and/or damage in their Units, and the Association shall notify the Developer of the discovery of mold, mildew, and/or water intrusion and/or damage in any part of the Condominium should the Developer own any Units at that time.

Section 15.04 Gender/Number. Whenever the context so permits, the use of the plural shall include the singular, the singular shall include the plural, and any gender shall be deemed to include all genders.

Section 15.05 Exhibits. Exhibits “A,” “B,” “C,” “D,” “E,” “F” and “G” attached to this Declaration are an integral part of this Declaration.

Section 15.06 Invalidity and Severability. It is the intention of the Developer that the provisions of this Declaration are severable so that if any provision is invalid or void under any applicable federal, state or local law or ordinance, decree, order, judgment or otherwise, the remainder shall be unaffected thereby.

Section 15.07 Interpretation. The provisions of this Declaration shall be liberally construed to effectuate its purpose of creating a uniform plan for the development and operation of a condominium project. Failure to enforce any provision hereof shall not constitute a waiver of the right to enforce said provision or any other provision hereof.

[SIGNATURE PAGE FOLLOWS]

IN WITNESS WHEREOF, the Developer has hereunto set its signature and seal on the day and year first above written.

[XYZ] DEVELOPMENT, LLC, an Alabama limited liability company

By:
Its:_____

STATE OF ALABAMA)
COUNTY OF JEFFERSON)

I, the undersigned, a Notary Public in and for said County in said State, hereby certify that _____ as _____ of **[XYZ] DEVELOPMENT, LLC**, an Alabama limited liability company whose name is signed to the foregoing Declaration of Condominium, and who is known to me, acknowledged before me on this day that, being informed of the contents of the above and foregoing Declaration of Condominium, executed the same voluntarily on the date the same bears date on behalf of said company.

Given under my hand and official seal of office this _____ day of _____ 20____.

[NOTARIAL SEAL]

Notary Public
My Commission Expires:_____

[MORTGAGEE]

By: _____
Name: _____
Title: _____

STATE OF _____)
COUNTY OF _____)

I, the undersigned, a Notary Public in and for said County in said State, hereby certify that _____ as _____ of **[MORTGAGEE]**, whose name is signed to the foregoing Declaration of Condominium, and who is known to me, acknowledged before me on this day that, being informed of the contents of the above and foregoing Declaration of Condominium, executed the same voluntarily on the date the same bears date on behalf of said company.

Given under my hand and official seal of office this _____ day of _____ 20__.

Notary Public

[NOTARIAL SEAL]

My Commission Expires: _____

EXHIBIT A
LEGAL DESCRIPTION OF PROPERTY

EXHIBIT B
ADDITIONAL PROPERTY

EXHIBIT C
BYLAWS OF
[XYZ] CONDOMINIUM ASSOCIATION, INC.

EXHIBIT D
PLAT AND PLANS

[See Attached]

EXHIBIT E**COMMON ELEMENT ALLOCATED INTERESTS, LIMITED
COMMON ELEMENT ASSIGNMENTS AND VOTES**

Unit #	Limited Common Element Parking Space Assignment	Limited Common Element Storage Space Assignment	Vote(s)	% Common Element Allocated Interest
Unit				%
Unit				%
TOTAL				100%

EXHIBIT F**ALLOCATED INTEREST UPON
ADDITION OF ADDITIONAL PROPERTY**

Upon addition of any portion of the Additional Property or any additional Units to the Condominium, the Common Element and Limited Common Element Allocated Interest assigned to the additional Units shall be calculated by dividing the approximate square footage of each additional Unit by the total square footage of all Units then-existing in the Condominium. The Allocated Interest of all previously-existing Units in the Condominium will likewise be reduced by dividing the approximate square footage of the Unit by the square footage of all Units then-existing. The square footage of the Unit to be used for each Unit is the square footage calculated from the architectural plans by a computer program measuring from the interior surface of the exterior boundary walls of the Unit. Upon adjustment of the Allocated Interests, the Limited Common Expense liability shall likewise be adjusted.

Upon addition of any portion of the Additional Property, the votes for each additional Unit shall be the comparable number of votes assigned to Units previously existing in the Condominium of a comparable size.

EXHIBIT G

EASEMENTS AND RESTRICTIONS OF RECORD



MONTEVALLO ROAD LOOKING WEST

P-22-16

Petition Summary

Request to rezone a 4.2 acre property from Residence-B to Planned Unit Development (PUD) for a mixed-use (multi-family and single-family) residential development.

Subject Property and Surrounding Land Uses

The subject property is comprised of the Shades Valley Presbyterian Church site and two adjoining single family lots on Montevallo Road, all zoned Residence-B.

To the north, across Montevallo Road, is the Brookhill Condominium development and the Brookhill Manor detached single family development (both in the city of Birmingham). To the east are detached single family homes on Montevallo Road and on Chester Road (zoned Res-B), and detached single family homes on Brook Manor Drive (zoned PUD). To the west is the Express Oil Change (in the city of Homewood); and to the west and south is the U.S. Highway 280 right-of-way.

Existing Zoning

The existing zoning of the subject site is Residence-B, which is a single family zoning with the following develop parameters:

Minimum lot size: 10,000 square feet

Minimum road frontage and lot width: 75 feet

Private Roads are not permitted in Res-B, therefore, a public right-of-way with a minimum 50-foot width would be required by the city's Subdivision Regulations for a single family subdivision with no change in zoning.

Staff estimation of how this property could be developed with Res-B zoning is that approximately 7 single family lots and a 50-foot right-of-way would likely fit on the church site (not including the two single family lots that are part of the subject property as well).

However, this is not to say that a single family subdivision with up to 14 standard Res-B lots couldn't be built on the subject church property with the approval of a rezoning to PUD, incorporating a private road.

Project Scope

The proposed development consists of two stacked flats buildings fronting on Montevallo Road (each containing 16 flats, for a total of 32 units), and 14 detached single family home sites to the south of the stacked flats buildings, organized around a private road/motor court.

Village Master Plan

Excerpts from the Mountain Brook Village Master Plan are attached and pertinent sections have been highlighted.

As may be seen in attached *Land Use Policy Map*, there are two Land Use Categories and one Special Policy Area pertaining to either the subject site or immediately adjoining sites along the same side of Montevallo Road.

Subject site: the subject site (including the two single-family lots) is designated for **Civic Use** in the Master Plan. This category suggests permitted uses such as schools, public parking, libraries, churches, and public offices. This designation (established in the 2007 adoption of the Village Master Plan) was likely put forth to match the existing church use on the property at that time.

Adjoining Sites on Montevallo Road: to the immediate east of the subject to property are three single family sites (plus the Bromberg's parking lot). As may be seen in the attached *Land Use Policy Map*, these are designated for **Village Residential Use**. This category suggests townhomes or stacked flats.

Special Policy Area 4: The same four adjoining sites noted above as also designated in the Master Plan as *Special Policy Area 4*. This designation notes that, due to the narrow street frontage and the depths of the lots, any future redevelopment should include only the townhouse building type of the Village Overlay Standards and Residence F as the base zoning district.

While the proposed PUD does not perfectly align with the land use plan policy map (mainly given the Civic designation), it does align with the overall master plan goals for Mountain Brook Village with respect to:

- ✓ The provision of an enhanced gateway to the City of Mountain Brook;
- ✓ The provision of new development around edges of the village, which contributes to the vitality of the village core;
- ✓ The provision of alternative residential formats that are needed to add viability to any future village-like development;
- ✓ Connecting or improving pedestrian connections through the village, building on the city-wide network established on Cahaba Road and Montevallo Road.

The proposed mixed-use residential project does promote the spirit and intent of mixing compatible, neighborhood-oriented uses that create human interaction and synergy. As to the Montevallo Road corridor, the project would be a natural transition from the commercial core of the village, through what the Master Plans anticipates will be townhomes properties to the east, and to the stacked flat concept for the subject site.

Highway 280 Gateways

In 2017, the city council amended the PUD chapter of the zoning code to identify and make eligible for zoning to PUD certain intersections located along Highway 280. Prior to said amendment, the PUD ordinance limited village properties eligible for rezoning application to those with a minimum of 4 acres, and limited non-village properties eligible for rezoning application to a minimum of 12 acres.

The city council recognized that there are some unique properties at the intersections along Hwy 280 that don't fit this minimum acreage criteria but may lend themselves to being rezoned to PUD (rather than other to non-custom zoning districts), when a PUD designation would likely be more favorable, as it allows the City more control over development at these gateways through the custom zoning of a PUD. The gateway intersections adopted in the PUD ordinance are as follows:

- Hollywood Boulevard/Montevallo Road (*subject property*)
- Office Park
- Shades Creek/Mountain Brook Parkway
- Cherokee Road
- Overton Road
- Green Valley Road
- Pump house Road
- Cahaba River Road

Due to the fact that most of the intersections identified as good candidates for PUD zoning are not within the designated villages (and therefore not governed by the Village Overlay Standards) a section was also added to the PUD ordinance which allows PUD applications in these Hwy 280 gateways to utilize the provision in the Village Overlay Standards which allows the council to review and approve alternate/reduced parking, based on recognized industry sources, such as the most recent edition of the Urban Land Institute Shared Parking Model or other similar and equivalent study or data, and upon evidence that such model is applicable to a proposed PUD application.

Hollywood Boulevard Gateway

Since the subject property has been identified by the city council as a *Gateway* to the city, it is important to consider how the gateway concept might appropriately differ in its presentation to the primary road and surrounding context than other interior properties of the city might. The planning commission should consider how building form, height, massing, scale, and density might take on a different meaning at a designated *Gateway* than it otherwise would.

The immediate context of the subject property

As may be seen on the *Vicinity Map*, Section 10 (page 31 out of 261), the subject property is two lots east of the Highway 280 off-ramp onto Hollywood Boulevard, with the Express Oil Change in between the off-ramp and the subject site. The subject site is the first site within the Mountain Brook municipal boundary, so it does shoulder some responsibility with regard to travelers' first impression of the City, and to the sense that they are "entering" a special place (*Mountain Brook!*).

In regard to "place making" and gateways, the architecture and scale of the gateway site should be intentional and well thought out. The scale of the gateway buildings, to the extent possible (not being able to control off-site improvements) should be harmonious with the scale of those in the immediate vicinity and, taken together as a whole, should give the traveler a sense that they are crossing the threshold into a defined space.

The proposed *Renderings/Elevations* reflect the architectural style that has come to be cherished in Mountain Brook, and the taller scale of the proposed street-front buildings works together with the scale of the Brookhill Condominiums building across the street to create a cohesive gateway feature with regard to massing and density.

It should also be noted that in addition to the Brookhill Condominiums, Brookhill Manor is also across Montevallo Road from the subject property (in the city of Birmingham). Again, referring to the *Vicinity Map*, Section 10 (page 31 out of 261), it may be seen that the Brookhill Manor development is similar in density, massing, and scale to the single family detached footprint for the proposed PUD. Brookhill Condominiums sits on 3.35 acres, and Brookhill Manor (10 detached residential lots) sits on 2.33 acres; both are accessed via private road. So there is a similar, positive synergy that may be created in this gateway with respect to its effect on Montevallo Road and Mountain Brook Village.

Village Overlay District

The Village Overlay District governs village areas of the City as designated on the *Building, Development & Regulating Maps* of the overlay district. Generally speaking, the Village Overlay district provides regulations aimed at shaping the character and use of structures and improvements within the villages, to promote and preserve the unique character of each village, and to encourage pedestrian use of each village.

As may be seen on the attached *Building, Development & Regulating Map* for Mountain Brook Village, the subject site is located within the area governed by the *Village Overlay*. However, said map specifically excludes the subject site from the requirements of the village overlay, indicating that it is “governed by base zoning standards only,” which in this case is Residence-B. How this is interpreted is that if the site were to be redeveloped as a Residence-B project, the proposed development plan would only be measured against the basic Residence-B zoning standards (and not by the *Village Overlay* standards).

Base Zoning Districts Required

The PUD zoning standards require that any project application to rezone to PUD shall denote *Base Zoning Districts* as part of the PUD application; this is in order to provide a “jumping off point” for the sake of comparing the proposed development plan to that of another similar base zoning district allowed by the City’s zoning code.

Section 124-264 of the PUD zoning regulations indicates that the proposed project shall generally meet the standards of the applicable base zoning district(s) included in the master site plan with regard to:

- Spacing and setbacks of buildings and structures
- Building Height
- Number of Stories
- Parking and parking design requirements
- Density
- Other as applicable

Modification from these requirements may be made through the proposed PUD master development plan, and deviations from the base zoning standards (and the reasons for deviations) shall be noted in the PUD application. The planning commission may recommend and the city council may approve arrangements that better meet the purposes of this district or any applicable village master plan.

Depending upon the density of the proposed PUD and the type of uses proposed for the PUD, the planning commission may recommend and the city council may require such building setbacks for any front yards, side yards, or back yards, along with such buffers, walls, hedges, shrubs, trees, and other designed transitions as the city council deems necessary and appropriate for the preservation of the character of other property in the vicinity of the PUD.

Base Zoning Districts Proposed

In this case the applicant has chosen **Residence G** district as the base zoning district for the multi-family footprint of this project, and the **Residential Infill** district as the base zoning district for the detached single family footprint of this project.

Section 8 (pages 10-12 of 216) describes the ways in which the proposed project conforms to the Residence G base zoning district; and for areas where deviation from those standards is proposed, how and why the deviation is proposed.

Section 9 (page 13 of 216) describes the ways in which the proposed project conforms to the Residential Infill base zoning district; and for areas where deviation from those standards is proposed, how and why the deviation is proposed.

General Purpose and Applicability of a Planned Unit Development (PUD)

“The Planned Unit Development (PUD) district is designed to permit flexible development of projects which are comprehensively planned as a single development with a functional master development plan which fully considers the entire site as an integrated project and gives broad consideration to impacts and relationships to surrounding areas. The PUD district permits flexibility in locating buildings, mixtures of building types and land uses, and open spaces.

The PUD plan shall encourage more efficient development and use of land which results in one or more of the following benefits to the general public *that could not be gained under standard zoning districts*, such as:

- a. Reduced negative aesthetic and environmental impacts from buildings and site development facilities, including better management of or reduction in the environmental impacts of development on the surrounding community;
- b. A better relationship between buildings, streetscapes, and public or common open spaces, resulting in an integrated community character that considers

extensions and transitions to adjacent areas, as well as relationships to the particular characteristics of the site;

- c. Less burden of traffic on streets, roads, and highways, including better pedestrian accommodations and connections; or
- d. Exemplary design of buildings and civic spaces which reinforces and complements the existing character of surrounding areas.

In recommending the permitting of such flexibility, the Planning Commission should consider policies or goals in the City's Village Master Plan and other broad public benefits demonstrated in a master development plan. The Planning Commission may attach conditions to a master development plan proposed for a PUD to safeguard the public health, safety, and general welfare."

Proposed Land Uses

The overall site layout may be seen in the proposed Section 4 (page 6 of 216) *Master Development Plan*.

Stacked Flats

Primary access to the stacked flats is from Montevallo Road. Structured parking is beneath the stacked flats. There are three stories of dwelling units proposed, with units also proposed within the pitched roof element above. A swimming pool amenity is proposed to the rear of the buildings.

While the general massing of these buildings are supported by the Gateway concept, and by the city's Village Master Plan's encouragement of more dense residential development on the fringes of the village, special care must be taken with regard to the scale and massing of these two buildings and their effect on the single family dwellings to the immediate rear (south and east) on Chester Road. Not only are the homes on Chester Road one and two-story buildings, but Chester Road, itself, is at a lower elevation than the subject buildings along Montevallo Road.

Detached Single Family Dwellings

The detached single family footprint is located behind the stacked flats. The single family homes contain individual parking garages on each lot, along with fourteen visitor parking spaces in the common motor court (private road). While the overall layout of the single family footprint may be seen in the *Master Development Plan*, a view of a typical, individual lot floor plan, outdoor amenities, and landscaping may be seen in the *Pattern Book*, Section 9 (page 15 of 216).

Density

For the sake of citywide context, at the end of this report there is a list of other residential PUD's of similar density to that which is herein proposed, as well as a list of the Residential Infill developments with similar density.

One PUD comes to mind due the nature of its previous use being a church site, rezoned in 2007 to PUD and converted to detached single family homes; Village Place on Montclair Road (previously site of the Pilgrim Church). Notably, this project serves as a gateway into Crestline Village, with its unmistakable “Mountain Brook” architectural treatment and charm, adding visual and place-making, pedestrian scale value to what is otherwise an unremarkable stretch of vehicular oriented roadway on the fringe of Crestline Village.

Village place sits on 6.59 acres, with 15 detached single family homes, and a private road/central motor court. The density is 2.27 homes per acre. Like the subject Hollywood Gateway PUD, Village Place fronts a streetscape of high vehicular traffic, once completely lacking in pedestrian value or connections. It also abuts traditional single family neighbors on three sides, so bringing this PUD vision to fruition through architectural design and engineering was fraught with some of the same challenges that the subject prefect faces. It too, was met with community concern and reluctance, and the developer and his team worked with the planning commission and city council to arrive at a project outcome that added density and pedestrian scale to the gateway to Crestline Village, while at the same time taking into careful consideration the design characteristics that would protect the neighboring properties and make the transition between the PUD site and them more seamless.

Access

Perhaps more so than density, there is special concern about this SFR portion of the Hollywood Gateway PUD’s vehicular access. There is no vehicular connection between the stacked flats and the single family homes. Primary access is proposed from Chester Road (east) and secondary access from Montevallo Road via a public alley (west). Residents of Chester Road have expressed understandable concerns about the utilization of Chester Road for primary access to the PUD site, siting increased traffic and overflow parking as primary causes for apprehension.

As to the dedicated alley along the west boundary of the subject property, the *Perimeter Survey*. Section 11 (page 32 of 216) documents the recording information (map book/page) where a 10-foot wide alley right-of-way was recorded by plat; however it has never been opened, paved, or maintained by the city of Mountain Brook.

On the same Section 11 (page 34 of 216), the *Site Layout Plan* shows proposed secondary access to the single family portion of the site via a 20-foot vehicular path with a 16-foot paved surface (this is inclusive of the 10-foot wide public alley).

It is unclear how the applicant wishes to proceed with this the enhancement of this access. Either the alley could be vacated, and it (taken together with the proposed expanded drive width) could be a private road to be maintained by the subject homeowner’s association, or the expanded width could also be dedicated to the public and serve to widen the public right-of-way (alley) for this access point.

Open Space

The area at the south (low) end of the property is designated as open space, and is to be used for natural drainage, along with optional park, playground, and trails. The landscape plan denotes only that underbrush is to be cleared.

Permitted Uses

The proposed permitted uses may be seen in Section 6 (page 8 of 216) *Permitted Uses*. The proposed permitted uses are fairly straightforward with specific lists of permitted uses within each following categories:

Multi-family
Single Family
Open Space
Public Use Area

** The only use that may be of special note is that which is listed under Public Use Area: *“Special events, including festivals, parades, races, assemblies, gatherings and other events permitted under the City Code, provided such special events are sponsored and the sponsor thereof satisfies all requirements of the City Code with respect thereto.”*

Parking

What’s required for Res-G District?

The minimum off-street parking required for Res-G is:

- 2 spaces/dwelling unit
Exception: Projects over 20 dwelling units, and which may have a substantial mix of dwelling units which could be designed for families with fewer than two vehicles may propose an alternative parking ratio. The proposal for a reduced rate shall be based on demonstrated and convincing market and demographic data regarding the parking demand per each dwelling type included in the mix. Approval of an alternative ratio is in the sole discretion of the city council, based on a recommendation of the planning commission.
- Visitor parking when 11 or more units: 5 spaces plus 0.25 spaces for each unit exceeding 10. (10.5 spaces in this case)
- Parking for all residential uses shall be located in the rear of any residential building, and no parking shall be permitted in any front yard; provided, however, that required parking for visitors may be permitted in the front of any building if located on-street and if said spaces are new spaces either dedicated or made available for public use.

What’s proposed in the Stacked Flats Footprint?

- 1.5 spaces/dwelling unit in structured parking beneath building; however, no demonstrated and convincing market and demographic data regarding the parking demand per each dwelling type included in the mix has been submitted with the PUD application.

- 13 on-street visitor spaces in the Montevallo Road right-of-way; however, these spaces are not “new,” but are in existence along Montevallo Road today (albeit not utilized by the public).

*Note: The Village Master Plan, in 2007 indicates, “Longer-term parking located along Montevallo Road (west of Cahaba Road) is observed to be consistently available.” This has been the City’s observation of the existing on-street all day parking in front of Shades Valley Church.

What’s required for detached single family uses in the Residential Infill District?

The RID district does not specify a minimum number of parking spaces per dwelling unit; it only indicates only that it be “off-street.”

What’s proposed in the Detached Single Family Footprint?

- 2 off-street spaces/dwelling unit in enclosed garages
- 11 parallel visitor spaces in the motor court (internal private access road)

Pattern Book

Section 9 (pages 15-30 of 216) illustrates the proposed architectural styles and materials to be used for the detached single family dwellings, such as treatment of porches, brackets, doors, windows, exterior lighting, chimneys, trim, and siding, and roofing.

Landscape Plan

The proposed landscape and planting plans indicate an overall design of landscape and buffers (placement of trees and shrubs, and species plant list) and make references to required/proposed numbers of trees, shrubs and fencing.

Of note are evergreen buffer trees and medium-large shrubs along the east and south borders of the stacked flats portion of the site (along adjoining residential properties located on Montevallo Road and the north side of Chester Road). Also, a 7-foot high masonry wall along the east perimeter of the single family portion of the site (along adjoining single family properties at the west end of Chester Road).

What does the Zoning Code say about Requiring Buffers in Conjunction with Rezoning?

Section 129-296, Buffers:

In cases in which a buffer, a green belt or a privacy fence is recommended by the planning commission or required by the city council (between subject and adjoining parcels), the following shall constitute the minimum requirements therefore, unless otherwise specified in individual cases:

“Buffers and green belts. For a buffer or green belt, a planted strip of land at least 15 feet in width, composed of living deciduous or evergreen trees spaced not more than 10 feet apart, and at least one row of dense evergreen shrubs spaced not more than 5 feet apart,

all of which shall be maintained in perpetuity by the property owner who is required to establish such buffer or green belt, or his heirs, successors or assigns.”

** The proposed landscape plans do not indicate the width of buffers or spacing of individual plants.

Sidewalks

The Res-G district requires the following for sidewalks:

“Sidewalks of not less than five feet in width shall be provided between any parking area and the building or buildings which they serve, and there shall be a curb between all parking areas and any adjacent sidewalk.”

Several years ago the City installed sidewalks on the subject side of Montevallo Road, spanning from the subject site to the core of MB Village, in order to make the pedestrian connection to long-term parking more accessible. The applicant proposed to leave this sidewalk intact (or if disturbance is required, to return it to city standards and materials as used by the City’s Public Works department).

City Fire Department Access

As may be seen throughout the plans for this project, Chester Road (an existing 40-wide public right-of-way) terminates in a “circle” at its west end (just adjoining the subject property). In speaking with the City’s Fire Marshal about current emergency access at the end of Chester Road it has been indicated that an emergency vehicle can maneuver around the Chester Road circle, but must enter the church property for turnaround in order to exit the end of Chester Road.

The proposed site layout plan depicts an extension of the 40-foot Chester Road right-of-way (private in the case of the subject property) with an internal hammerhead configuration on the motor court.

Here is what the City’s Fire Marshal has to say about his initial review of the proposed site layout:

“I am comfortable in saying a hammerhead meeting the requirements of 2021 IFC would be sufficient; however, I’m still unsettled about the width of Chester Road and the fire hydrant locations. Below you will find a list of concerns for the subject project:

- Without any vehicles parked on the side of the street (Chester Road) there is an average of 21 feet of clearance.
- With parked vehicles on the side of the street (Chester Road) there is an average 16 feet of clearance (these numbers were based off the circle).
- There are two fire hydrants, one being located on Chester Road and the other in front of Gilchrest Pharmacy. The hydrant located on Chester Road is 534 feet from the proposed entrance. The hydrant located on Cahaba Road is 925 feet from the front of the proposed structure facing Montevallo Road. Although there is a fire hydrant in front of Express Oil Change it belongs to the city of Birmingham, and so the city of

Mountain Brook does not have any responsibility in maintaining it. My concern is the distance to the front of the proposed structure of Montevallo Road from the hydrant located on Cahaba. I would like to see if we could possibly propose a new hydrant location.”

Effect on Schools

The potential effect of new dwelling units on Mountain Brook Schools should be given careful consideration.

For the sake of context, the Mountain Brook school board has provided staff with some data on the newly constructed Lane Parke apartments: There are 31 school-age children from 21 families living in the 276 units in Lane Parke (or 0.11 students/unit).

2017 School Enrollment Study – Mountain Brook Schools

In 2017 the City undertook a study of how many school age children enrolled in Mountain Brook schools lived in multi-family dwellings; and the study was further broken down by type of multi-family dwelling as follows:

154 School Age Children
1236 Multi-Family Units

Of the 154 school age children:

73 students resided in 865 stacked flats	(0.08 student/stacked flat)
54 students resided in 305 townhomes	(0.17 student/townhome)
27 students resided in 66 duplexes	(0.40 student/duplex)

Using this estimate for the proposed PUD multi-family component of 32 stacked flats, it might be expected that 2.56 students would reside in the 32 stacked flats footprint (32 stacked flats @ city average of 0.08 students/stacked flat = 2.56 student).

While the city does not have statistics on the number of school age children that reside in SFR staff contacted the MBBoE (2022) for a small sampling of the number of students enrolled that live on Village Lane (the PUD discussed previous section of this report) and on Chester Road (very similar to the proposed SFR density, at 3.95 acres and 12 SFR). There are presently zero students living in the Village Lane PUD development, and there is one student living on Chester Road. This might support the idea that families with children (in Mountain Brook) tend to gravitate toward larger footprint SFR lots.

All of the above samplings give an indication that the proposed project may have very little impact on school enrollment (perhaps as low as 4 students for the PUD taken as a whole).

Traffic Study

The *Traffic Study* is attached for review. Levels of service (both existing and projected appear to above the acceptable range). Below are a few excerpts from the traffic study to note:

Planned Roadway Improvement Project (Page 46 of 216)

“In 2018, the cities of Homewood and Mountain Brook began efforts to modify the existing Hollywood Boulevard bridge over U.S. Highway 280 to add a pedestrian walkway. With additional funding from Jefferson County and the State of Alabama as well as private donors, the project is currently moving forward in the design process under the direction of Jefferson County Roads and Transportation. AECOM was hired in September, 2021 to prepare construction plans. The most current concept includes not only construction of a pedestrian walkway, but also widens the bridge to three travel lanes and installs a traffic signal at the east end of the bridge for traffic exiting the U.S. Highway 280 ramp. The conceptual plan is shown below. Expected bid letting is in August, 2022.”

Trip Generation (Page 49 of 216)

“The trip generation potential for the proposed development was estimated based on information contained in the Institute of Transportation Engineers publication Trip Generation, 11th Edition. The trip generation estimate for the proposed development is shown in Table 5.”

**Table 5
Trip Generation**

Land Use	Size		ITE Code	Daily			AM Peak Hour			PM Peak Hour		
				In	Out	Total	In	Out	Total	In	Out	Total
Condominium	32	d.u.'s	220	108	108	216	3	10	13	10	6	16
Single Family	14	d.u.'s	210	83	83	166	3	9	12	10	6	16
Total				191	191	382	6	19	25	20	12	32

Recommendations (Page 49 of 216)

“The findings of this report are that no roadway improvements are required to mitigate the traffic impacts of the proposed development. Levels of service remain unchanged from Background 2025 conditions to Future 2025 conditions with development traffic added. The proposed site access driveways can be constructed with two lane cross sections. No turn lanes are required at the site access points to provide adequate traffic operations.”

Association/Covenants

Section 129-264 (b) of the Zoning Code requires that the substance of covenants and other private deed restrictions to be imposed on the parcels within the PUD be submitted as part of the PUD application. The draft restrictions are attached to this application.

Commencement/Completion

Section 129-266 of the Zoning Code requires that construction of a PUD commence within one year of approval by the City Council and must be completed by the time schedule approved by the council in the PUD zoning document. Here is the proposed timeline:

- Obtain required entitlements: September 2022
- Begin Demolition and Site Work: Q1 2023 (D)
- Complete Single Family Lot Deliveries: Q3/Q4 2023 (D)
- Complete Condominium Unit Deliveries: Q2 2024 (D)
- Single Family Home Deliveries: Beginning Q3/Q4 2024 (P)

(Q) = Quarter (3 months)

(D) = Developer Activity

(P) = Lot Purchaser Activity

Other Potential Approvals:

Based on the attached preliminary site plan, the following additional approvals may be needed prior to any permit issuance.

Village Design Review Committee – approval of exterior elevations and signage (see proposed *Renders & Elevations*, as well as *Sign Concepts*).

Planning Commission - If the proposed rezoning is approved by the city council, then in accordance with the city's Subdivision Regulations the property would have to be resurveyed into lots that correspond to the proposed site layout plan, and said case would come back to the Planning Commission at that time.

Citywide Context

Other Residential PUD's and RID's in Mountain Brook are as follows:

Residential PUD projects:

Brook Manor in MB Village (5 acres/23 lots; mix of SFR and duplexes) – public road;
Village Place (previously Pilgrim Place on Montclair Road) (6.6 acres/15 lots) – private road;
Montevallo Park Place (on Montevallo Road) 10 acres/19 lots – private road;
Overton Cove in Overton Village (4.45 acres/13 lots) – private road.

Residential Infill (RID) projects:

Downing Place (on Montevallo Drive) (1 acre/6 lots) – private road;
Calton Hill (on Montclair Road) (1.57 acres/8 lots) – private road;
Botanical Place (on Cahaba, north of the zoo) (3 acres/11 lots) – private road;
Park at Overton (next to the Chabad) (4 acres/18 lots) – private road.

Affected Regulation

Article XVI, Planned Unit Development District

Article XXX, Residence G District

Article XXVIII, Residential Infill District

Article XXXI, Village Overlay Standards; Section 129-552(b), Permitted Uses and Building Type

Article XXXI, Village Overlay Standards; Section 129-553, Building Typology Standards;

Article XXXI, Village Overlay Standards; Section 129-557, Building and Development Regulating Plan, Overton Village

Article XXV, Amendments

Appends

LOCATION: 2305 Montevallo Road

EXISTING ZONING DISTRICT: Residence-B

PROPOSED ZONING DISTRICT: Planned Unit Development

OWNER: Shades Valley Presbyterian Church

AGENT: John Chapman

City of MOUNTAIN BROOK

MOUNTAIN BROOK VILLAGE

LAND USE POLICY MAP

PROPOSED LAND USE

-  Medium Density Residential
-  Mixed-unit ("Planned") Residential
-  Village Residential
-  Culture-Recreational
-  Office
-  General Commercial
-  General Commercial - Retail Dominant
-  Multi-Use
-  Civic
-  Village Boundary Line
-  Special Policy Area's Boundary

* for a complete set of future land use categories available city wide, see master plan

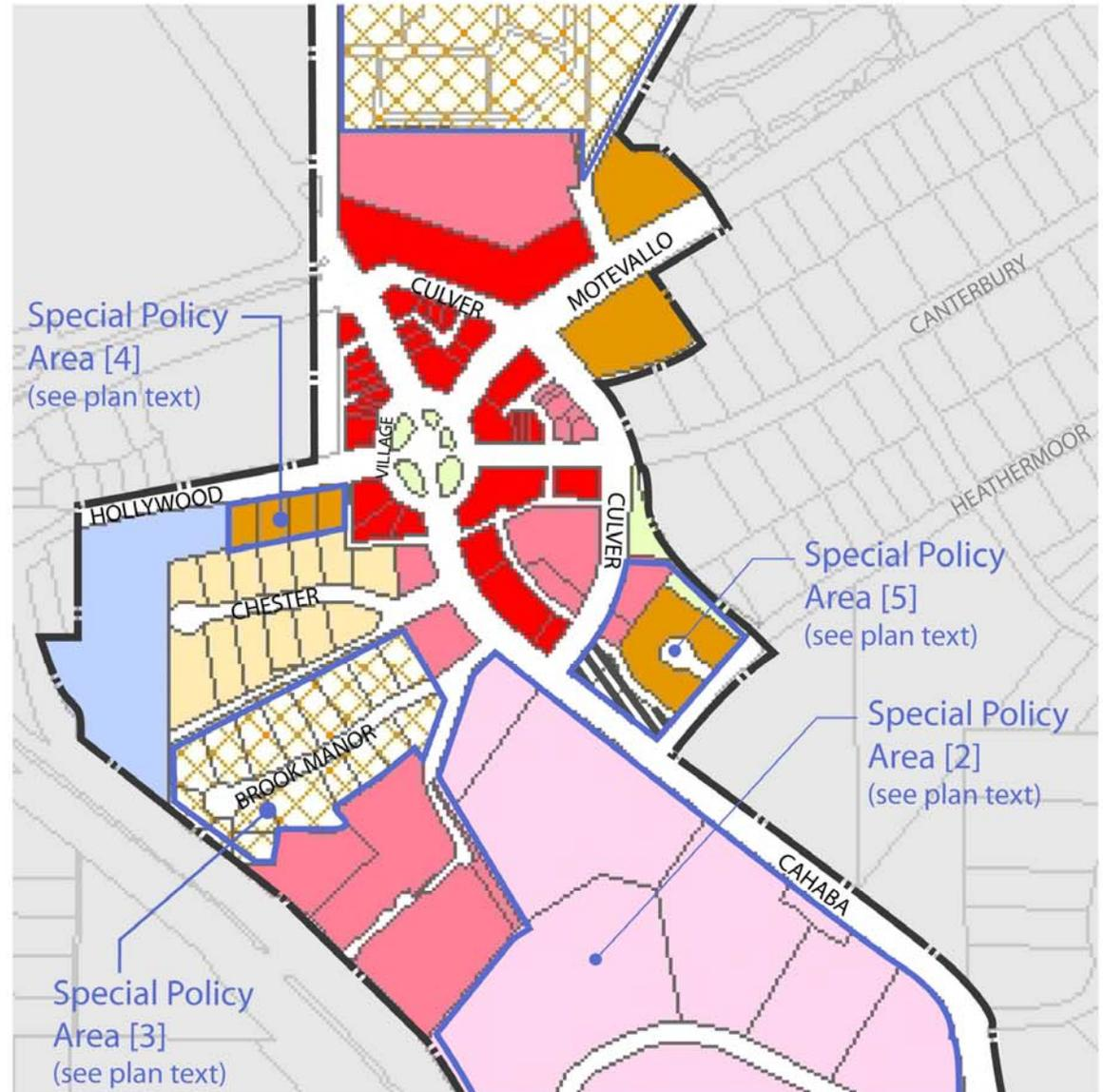

Residence A, Residence B, and Cluster Residential, although this also includes Estate lots that are less than two acres and are adjacent to Residence A zoning. The compatible existing zoning districts are Estate, Residence A, Residence B, and Cluster Residential.



Medium Density Residential – Land uses in this category include higher-density residential uses. They average three or more lots – or dwelling units – per acre of land. These lots range from 5,800 square feet to 9,680 square feet in size. The majority of the lots/developments in this classification are zoned Residence C, Residence D, and Residence E. They are single or attached dwelling units, but cannot be a single building containing three or more dwelling units. The appropriate implementation of this category is Residence C, Residence D, or Residence E.



High Density Residential – Land uses in this category are primarily intended to be single buildings containing a minimum of three dwelling units of apartments or condominiums (each). The appropriate implementation of this category is Residence D or Residence E.



Village Residential – Land uses in this category are primarily intended to be high-density, but are smaller-scale residential projects incorporated in or immediately adjacent to the Villages. Building forms are of primary importance in determining the compatibility with adjacent property. Density, parcel size and other non-design elements are of secondary importance. Village residential projects should include some civic or quasi-civic open space at the frontages, or otherwise provide formal residential frontages to fit in with the respective Village character and surrounding neighborhood. Townhomes and stacked flats are the appropriate building types in this category. The appropriate implementation of this category is Residence G, Residence F, Residence D, or other higher-density residential districts, as modified by any specific applicable planning and design recommendations for buildings in the Village.



Mixed-unit (“Planned”) Residential — Land uses in this category are primarily intended to be of an overall moderate density, but should reflect a wide range of dwelling and lot types designed as part of a single residential neighborhood design according to a plan. The goal is to present a mix of housing types in a compatible environment. Developments may include dwellings that range from large lot detached single-family to high-density multi-dwelling structures. Building size and scale is planned and located based upon topography and adjacent building scale and uses. Only large parcels or areas capable of presenting a critical mass to support a neighborhood plan and mixture of units are designated in this category. Single-family dwellings, duplexes, townhomes, and stacked flats are the appropriate building types for this category. The appropriate implementation of this category is a flexible or planned residential district (PUD), which should be guided by site-specific conditions and constraints, with the public or village-wide benefits identified in the specific site development plan for the area.



Civic – Land uses in this category are primarily public facilities, such as schools, playgrounds adjacent to schools, public parking, libraries, churches, and public offices. The appropriate implementation of this category is the Recreation District and all others that allow schools, libraries, museums, churches, and other public uses



Cultural / Recreation – Land uses in this category are primarily intended to be recreational parks, civic or quasi-civic open spaces. This includes both large and small recreational parks. The appropriate implementation of this category is the Recreation District and any others that allow public uses and open spaces.

vegetative buffer with property to the north. All green spaces and public spaces should be designed at highly visible locations as focal points for the site. An Open Space Plan for the PUD should include approximately 200 square feet of open space per dwelling unit, designed according to the Open Space Guidelines in Section 5.4

- Discrete and small parking areas should be used, located away from adjacent property, away from the streets and away from the Village center; any structured parking included in buildings shall be directed away from important streetscapes in the plan and disguised with improved building facades that reflect the residential character of the buildings.
- Stronger pedestrian connections into the Village should be incorporated into the development plan.
- Any increases in density beyond 20% of the current site density may require a traffic study, demonstrating potential impacts on traffic in the Village, particularly the functioning of the intersection of Brook Manor and Cahaba at critical times. If impacts are significant, and acceptable traffic mitigation cannot be designed within the site and PUD plan, the City may require reductions of the overall density of the plan.

[4] *Special Policy Area 4* represents the residential lots fronting on Hollywood Boulevard. Due to the street frontage and depths of the lots any future redevelopment of the residential lots, should include only the townhouse building type of the Village Overlay Standards and Residence F as the base zoning district.

[5] *Special Policy Area 5* represents the lots bounded by Culver, Cahaba, and Heathermoor. This area is

part of the retail core of the Village, and any future redevelopment should include a strong retail presence anchoring the corner of Cahaba and Culver. Redevelopment of this area may present better development opportunities and better designs in conjunction with the Master Plan goals if parcels are assembled and reconfigured. In the event that this occurs, redevelopment should incorporate the following principles:

- This site is identified as part of a possible parking solution for the Village. Future development should seek partnerships with the City to provide a “net gain” in parking by incorporating a parking structure into the grades and screened by buildings fronting Cahaba and the intersection of Cahaba and Culver.
- Commercial access to the site should be focused on Culver away from the Cahaba intersection, or allow some limited access off of Heathermoor. Any commercial access of Heathermoor should be located closer to Cahaba. Access points located further to the northeast on Heathermoor should be limited to residential uses.
- Redevelopment proposals shall be designed with substantial sensitivity to adjacent residences, and that the scale of buildings tapers down to two-story at the eastern portion of this special policy area.
- Any buildings that are constructed to front directly on Heathermoor shall be residential only.

3.0 MOUNTAIN BROOK VILLAGE MASTER PLAN

The Mountain Brook Village Master Plan is based primarily on the Vision, Value and Goals established through the public participation process. To achieve this Vision, all future development should be arranged and evaluated based upon three key plan components – (1) a future Land Use Policy Map (a plan for regulating use of land and buildings); (2) a Building and Development Regulating Plan (a plan for regulating building types and designs); and a Circulation and Urban Design Plan (a plan to guide coordinated public improvements and private site and building designs). Together these three components reflect a comprehensive approach to development in the Village, and guide the many private and public decisions that occur with new development in the Village.

3.1 VISION

Vision

Classic Mountain Brook - Our front door.

Mountain Brook Village is a community and metropolitan destination. True to the village pattern and inspiration of the original Mountain Brook plan, Mountain Brook Village preserves the small-scale pedestrian atmosphere while providing a modern retail shopping experience unique to metropolitan Birmingham.

Values

- Tradition - the initial vision for Mountain Brook Village, preserving its unique character and value as a destination.
- A gateway – to the City of Mountain Brook; to major metropolitan destinations; and to the adjacent neighborhoods.
- Eclectic, complimentary architecture, preserving the past and integrating the best of today.

- Independent and local businesses ensure that there is a unique and local flavor.
- A community village blended with the beauty of the natural surroundings.

Goals

- Maintain the core of Mountain Brook Village in tact – scale (1 and 2 story), streetscape (store-front buildings), and architecture (predominantly English-style).
- Ensure new development around edges of the village contributes to the vitality of the core of Mountain Brook Village.
- Develop a village-wide parking strategy (remote employee locations, structured district parking, on-street parking management).
- Seek opportunity for more evening business activity (dining or entertainment).
- Solve the flood problem.
- Connect or improve bicycle and pedestrian connections through the village, building on the city-wide network established on Cahaba Road and Montevallo Road.
- Enhance existing green space in the Village, and incorporate any new development sensitively into topography and existing vegetation in areas around the Village.

3.2 LAND USE POLICY MAP

The Land Use Policy Map is a plan that recommends future uses of land and buildings. It guides future zoning decisions and assists in considering a variety of future regulatory strategies that could implement the physical and policy recommendations of the Master Plan.

The map reflects some of the following general categories which are part of the City's overall land use policy framework. Not all categories are currently represented or recommended in the Village planning area. Where these categories and descriptions differ

City of MOUNTAIN BROOK

MOUNTAIN BROOK VILLAGE Village Center

CIRCULATION AND URBAN DESIGN PLAN

URBAN DESIGN ELEMENTS

-  Primary Village Street
-  Secondary Village Street
-  Village Support Street
-  Access-Service Alley
-  Passage (Ped or Ped/Vehicle)
-  Greenway
-  Landmark
-  Quasi-Civic / Public Open Space
-  Open Space & Landmark
-  Gateway
-  Public / Private Parking
-  Sensitive Border
-  Enhanced Crosswalk
-  Village Boundary Line

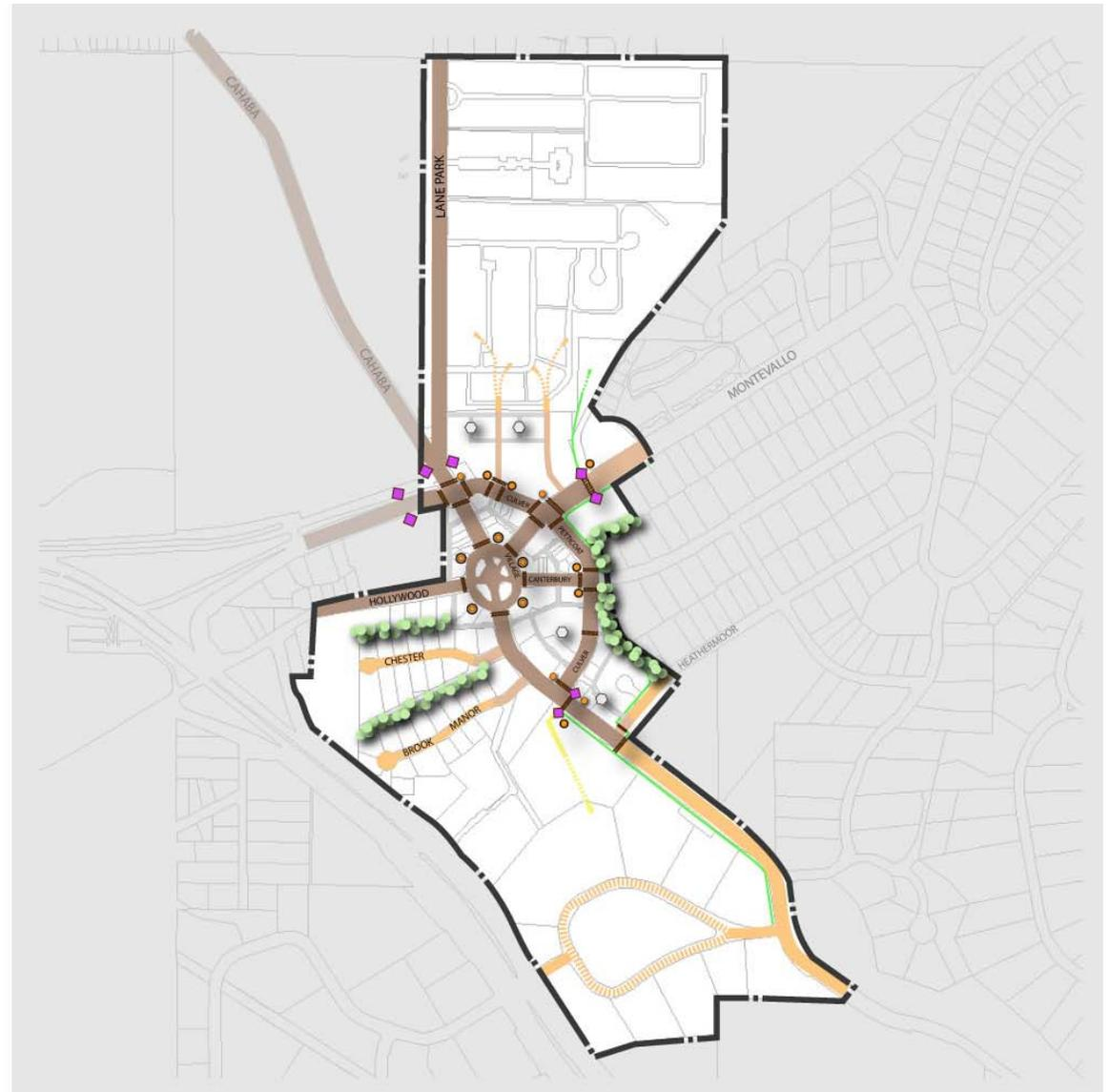

3.4 CIRCULATION AND URBAN DESIGN PLAN

The Circulation and Urban Design Plan is a plan for guiding design of multiple projects that may occur in different areas or at different times in a coherent village-wide manner to achieve a consistent character for buildings, sites and public and private open spaces. It identifies things that, while they may not necessarily be regulated or required of private development in every case, they are important to the overall function and aesthetic character of the Village and therefore benefit from a Village-wide plan guiding their application.

The elements of the Circulation and Urban Design Plan deal primarily with the design of the public realm, or aspects of private site development that significantly impact the public realm. It includes the design of either public rights-of-way and open spaces which are not the subject of regulations on private development, but which are often impacted by or reconstructed in association with private development. In addition, it includes aspects of private site development which may be desired but not always mandatory, and which can benefit from considering them within the context of a Village-wide plan prior to incorporating them into individual sites. Elements on the Circulation and Urban Design Plan are:

 **Primary Village Street** – A Primary Village Street is the most pedestrian oriented area of the Village. Vehicle lanes are narrow and balanced with wider sidewalks and maximized opportunities for on-street parking. It features frequent and more enhanced streetscape elements such as street-lights, benches, and landscape elements. Curb-cuts for vehicle access are limited or prohibited in favor of alleys or shared access provided off of Secondary or Support Streets.

 **Secondary Village Street** – A Secondary Village Street, while still reflecting the pedestrian character

of the Village, may accommodate more automobile access and a lower level of streetscape enhancements. It performs a secondary circulation function in the Village.

 **Access or Service Alley** – An Access or Service Alley is an area that accommodates service vehicles for businesses and secondary vehicle circulation or specific site access for vehicles. These areas may perform dual functions as a pedestrian Passage if enhanced design elements create a balance between pedestrians and vehicles or otherwise emphasize a priority for pedestrians through physical design elements.

 **Village Support Street** – A Village Support Street is a street that is generally not designed to perform a commercial function or support immediately adjacent commercial uses. Typically these streets are residential, and the design should primarily emphasize residential characteristics and pedestrian access to the Villages. Additionally, although residential in nature these streets may also be key access points for vehicles into the villages from adjacent areas.

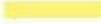
 **Passage** – A Passage is a linear area primarily designed for pedestrian traffic or balanced pedestrian and vehicle traffic, often providing mid-block connections between Primary and Secondary Village Streets or access to public spaces internal to a block.

 **Greenway** – A Greenway is a long, linear, and natural corridor that features a trail for pedestrians and/or bicycles.

 **Gateway** – A Gateway is a small, pedestrian-scale, ornamental structure usually located along a roadway that signifies a transition or entry to a unique area. Gateways typically include common design themes at separate and remote locations that collectively define the uniform character of the area, but should contain variations on the theme in order to best fit into the specific location of the Gateway.

 **Public Quasi-civic Open Space** – Public or Quasi-Civic Open Spaces are small, well-designed spaces that are

City of MOUNTAIN BROOK

MOUNTAIN BROOK VILLAGE Village Center

BUILDING AND DEVELOPMENT REGULATING PLAN

BUILDING FRONTAGE TYPES

- 
 Primary Frontage
 2 story
 3 story
- 
 Secondary Frontage
 2 story
 3 story
- 
 Support Frontage
 2 story
 3 story
- 
 Residential ("Neighborhood") Frontage
 2 story
 3 story
 4 story
- 
 Village Boundary Line
- 
 Area controlled by base zoning districts standards only

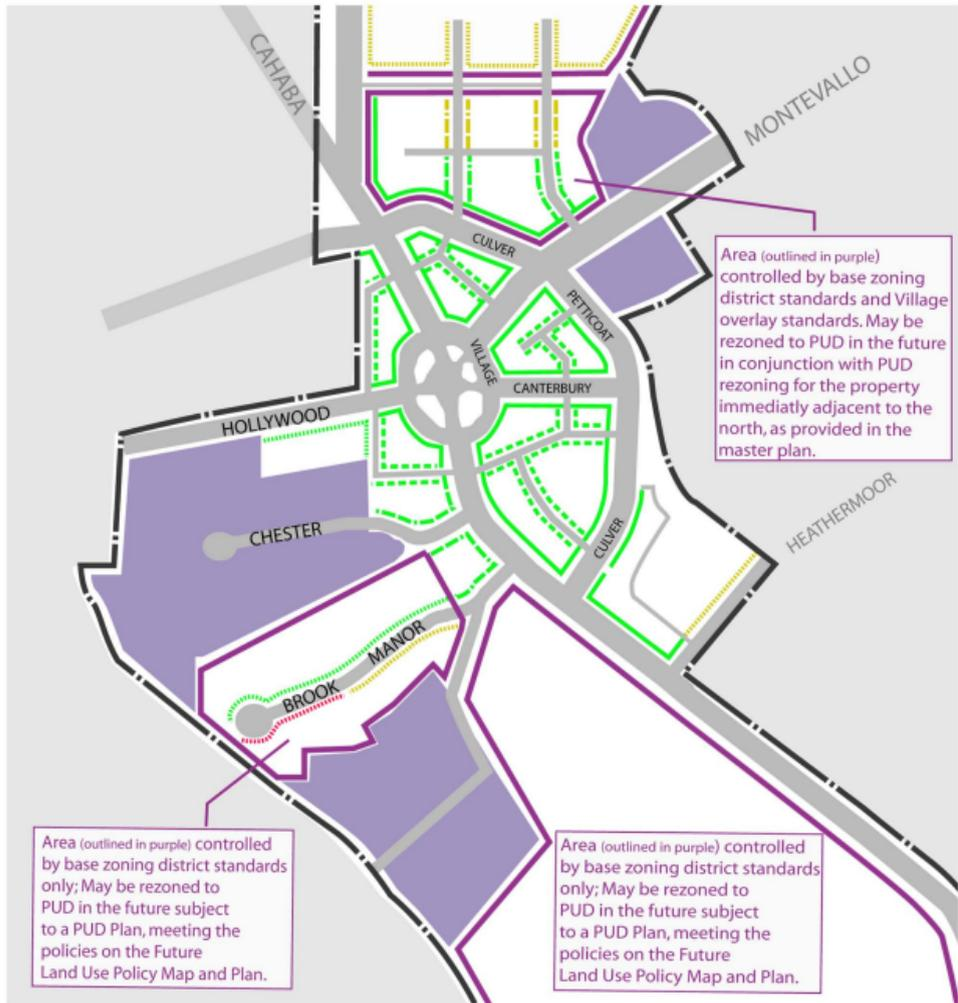

HOLLYWOOD BOULEVARD GATEWAY PUD



2305 MONTEVALLO ROAD

SUBMITTED 06.10.2022

INGRAM FARRIS LLC

NEQUETTE ARCHITECTURE & DESIGN

SCHOEL ENGINEERING

SKIPPER CONSULTING

BRASFIELD & GORRIE

TABLE OF CONTENTS

1. PUD Rezoning Application2

2. Defined Terms & Site Legend3

3. Statement of Development Objectives4

4. Master Development Plan6

5. Permitted Land Use Map7

6. Permitted Land Uses8

7. Open Space & Pervious Surfaces Plan.....9

8. Base Zoning District Standards10

9. Design Standards & Pattern Book15

10. Vicinity Map with Current Zoning31

11. Survey32

12. Utilities and Storm Drainage Plan.....33

13. Legal Descriptions.....34

14. Appendices35

A. Appendix A: Traffic Study36

B. Appendix B: Renderings...106

C. Appendix C: Three-Dimensional Model Images.....110

D. Appendix D: Conceptual Landscape Plan114

E. Subdivision Covenants117

F. Condominium Declaration.....161



Planning Commission Application PART I

Project Data

Address of Subject Property 2305 Montevallo Road - Birmingham, Alabama - 35223

Zoning Classification PUD

Name of Property Owner(s) Shades Valley Presbyterian Church c/o Dave Dresher

Phone Number Dave Dresher Email ddresher@cjd.law

Name of Representative Agent (if applicable)

John Chapman

Phone Number 205.939.1222 Email jchapman@wynnecapitalpartners.com

Name of Engineer or Surveyor Andrew Phillips - Schoel Engineering

Phone Number 205.313.1154 Email aphillips@schoel.com

Property owner or representative agent must be present at hearing

Plans

See applicable Section of the Zoning Ordinance for submittal requirements pertaining to your particular application. Applicable Code Section may be found in Part II, list of application types. Contact City Planner with any specific questions as to required plans submittal.

2. DEFINITIONS

As used in this PUD Application, the following terms are defined as follows:

1. **Architectural Styles** means the Architectural Styles more particularly described in the Pattern Book.
2. **Building Typologies** means the permitted building types and specifications more particularly described in the Pattern Book.
3. **City** means the City of Mountain Brook, Alabama.
4. **City Code** means the Code of the City of Mountain Brook, Alabama.
5. **City Council** means the City Council of the City of Mountain Brook, Alabama.
6. **Design Committee** means the City's village design review committee as defined in the City Code.
7. **Design Review Process** means the Design Review Process described in Section 9 of this PUD Application.
8. **Design Standards** means the Design Standards set forth in this PUD Application.
9. **Gross Floor Area** means the total enclosed floor area of all floors of a building (including mezzanines), measured from the exterior faces of exterior walls and from the center line of walls separating buildings, including basements, lobbies, common areas, elevator shafts, stairwells, mechanical or equipment rooms, common corridors, building amenity areas, storage areas, enclosed garages, and any other fully enclosed spaces of the building, whether leased to tenants or not. Gross Floor Area shall exclude rooftops, plazas, covered walkways, covered parking areas, outdoor dining or market areas, balconies, porches, terraces, loading docks, roof overhangs and any other non-enclosed areas (whether covered by a roof or not).
10. **Illustrative Master Plan** means the Illustrative Master Plan included in this PUD Application.
11. **Landscape Standards** means the Landscape Standards set forth in the Landscaping, Parks and Open Space Plan included in this PUD Application.
12. **Master Association** means any Master Association created in connection with the Master Declaration of Restrictions and Easements more particularly described in this PUD Application.
13. **Parcel** means the corresponding parcel of land identified as Parcel "1 – 3" on the Site Legend or any other legal parcel of land within the subject property currently existing or created in the future by a Preliminary or Final Subdivision Plat submitted in connection with the development.
14. **Pattern Book** means the Pattern Book included in this PUD Application.
15. **Permitted Density** means the total number of unique dwelling units permitted to be constructed within the development, as more particularly set forth in this PUD Application.
16. **Phase(s)** means any one or more of the phases of anticipated construction, consisting of an Earthwork phase, Multi-Family Residential phase, & a Single-Family Residential phase, each as more particularly described and shown in this PUD Application.
17. **Planning Commission** means the Planning Commission of the City of Mountain Brook, Alabama.
18. **Property** means the real property more particularly described in this PUD Application that is to be re-zoned to a Planned Unit Development District.
19. **Project Owner** means Ingram Farris, LLC., an Alabama limited liability corporation, and its successors and/or assigns.
20. **PUD Application** means this document, all schedules and exhibits attached hereto or provided in connection herewith, and all amendments and modifications hereto.
21. **Regulating Plan** means the Regulating Plan more particularly described in the Pattern Book.
22. **Residential Infill District** means the regulations and standards for the Residential Infill District set forth in Sections 129-491 through 129-499 of the City Code as in effect as of January 1, 2012.
23. **Unit** means any dwelling unit created on any Parcel within the Property.
24. **Use Area** means any of the Use Areas more particularly described in this PUD Application.
25. **Village Master Plan** means the Village Master Plans adopted by the Planning Commission as of June, 2007.
26. **Village Overlay Standards** means the regulations and standards for the Village Overlay District set forth in Sections 129-551 through 129-558 of the City Code as in effect as of January 1, 2012.



SITE LOCATOR MAP
NTS

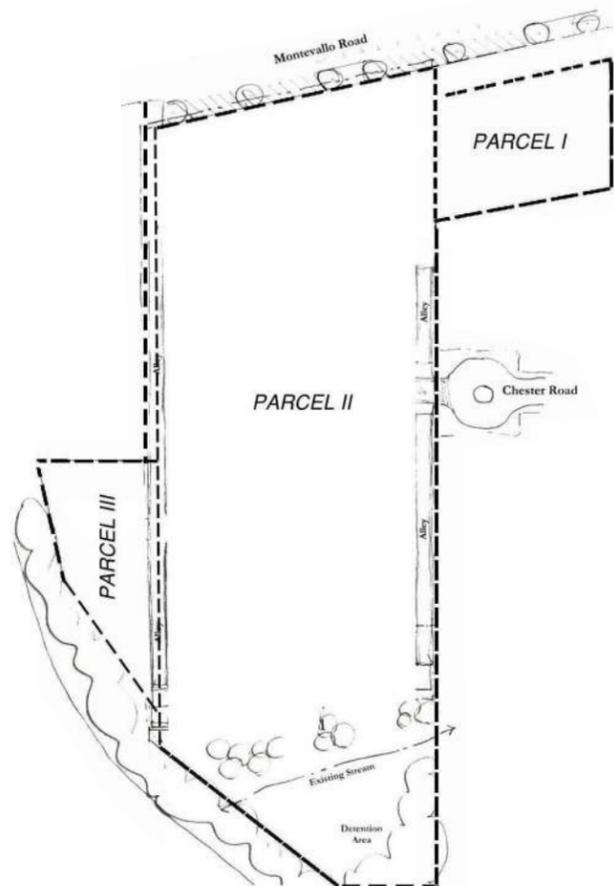

SITE LEGEND
NTS



3. DEVELOPMENT OBJECTIVES

Consistent with the goals and ideals of the Village Master Plans, 2305 Montevallo Road has been designed and planned around the following concepts:

- To be a Gateway into Mountain Brook Village that enhances and preserves the diversity of its architectural heritage and extends and encourages a pedestrian-scaled walkable village core.
- To enhance the Village by cultivating pedestrian connections, adding green space, improving storm water mitigation measures and providing ample parking.
- To create a variety of housing options aimed to attract empty nesters and current residents that want to live in a walkable environment while downsizing the space they need and minimizing the maintenance they are responsible for. When completed, this development will replace the defunct Shades Valley Presbyterian Church property with updated residential options not widely available in the surrounding area.
- The ±4 acre Property is ideally suited to act as a Village Core Gateway when comprehensively planned in accordance with the Planned Unit Development zoning classification established pursuant to Section 129-261 of the City Code. Accordingly, the Hollywood Boulevard Gateway Plan has been conceived in accordance with the following planning objectives:

1. To advance the vision for Mountain Brook Village as articulated in the Village Master Plans by (i) creating new development at the gateway of the Village that will contribute to the vitality of the Village as a whole, (ii) providing housing options that allow current residents to remain in Mountain Brook as their needs change, and (iii) attract new residents by offering housing options not prevalent in the surrounding area.
2. To preserve the character and tradition of Mountain Brook Village as a pedestrian friendly, community-oriented destination by extending that pedestrian-oriented environment from the village core to the gateway.
3. To design, construct and operate the gateway development in a manner that is sympathetic to the existing Village and minimizes impacts on adjacent neighborhoods by focusing on transitions between uses, setbacks, topography, vegetation, screening, and green space.
4. To complement the existing aesthetic of Mountain Brook Village by emphasizing architectural quality and promoting attractive and pedestrian oriented streetscapes.
5. To address current drainage and water management concerns by reducing the amount of impervious surface on-site and augmenting the existing storm water management system.
6. To minimize impact on existing traffic circulation by limiting access points while improving emergency access and circulation.
7. To minimize disruptions to the surrounding properties through restricted construction access.



EXISTING CONDITIONS



6/8/2022, 2:29:55 PM

- Municipal Boundary
- Lot Lines
- Community Shopping
- Local Business District
- Office Park District
- Residence B District
- PUD
- 2018 Aerial Red: Band_1
- Green: Band_2
- Blue: Band_3

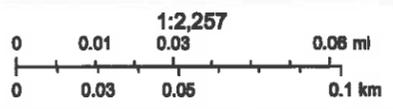

JeffCoAL, Esri, HERE, Garmin, GeoTechnologies, Inc., USGS, EPA, USDA | Jefferson County Information Technology Services | Hunter Simmons |

MUNICIPAL BOUNDARY

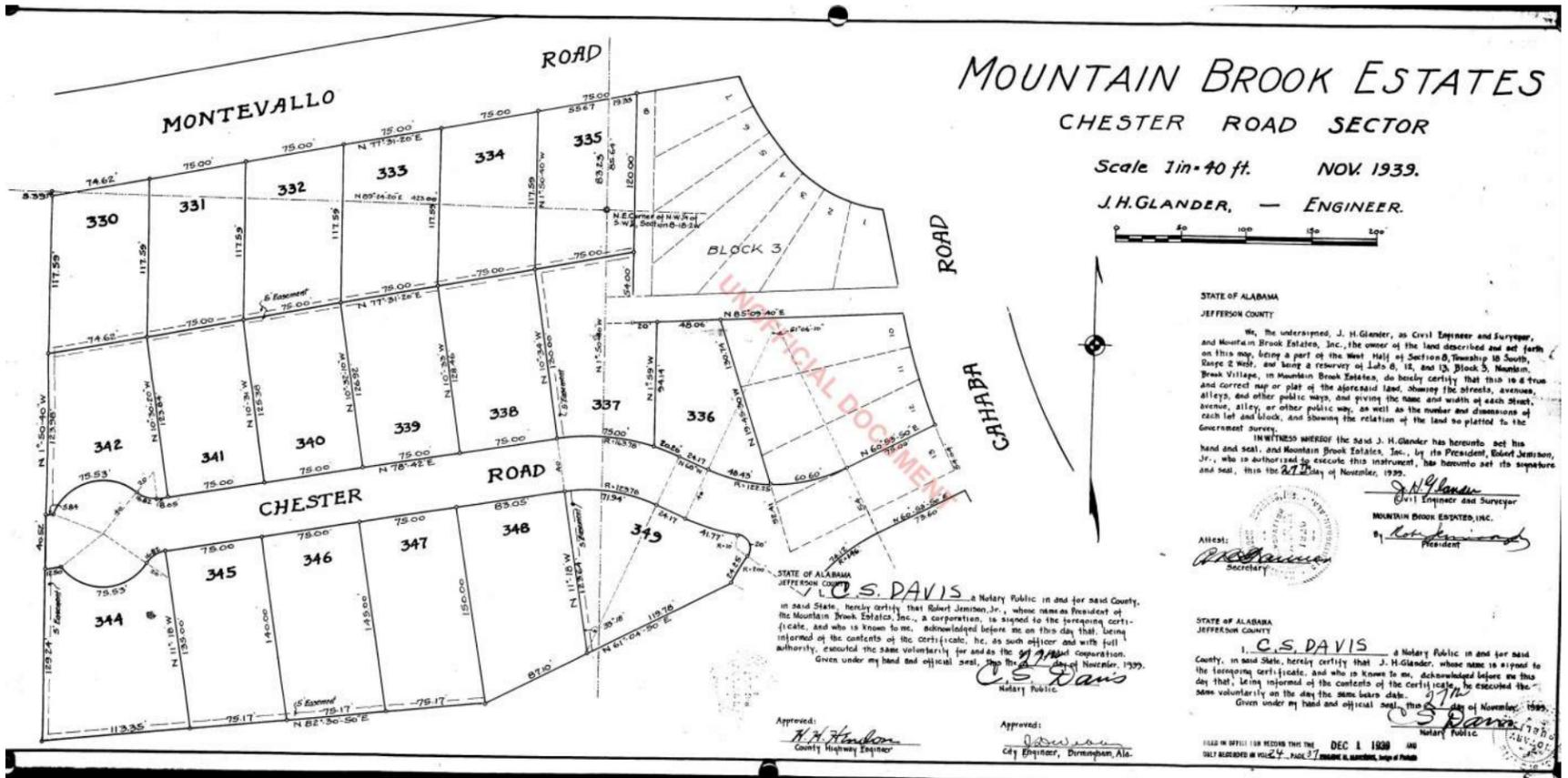

CHESTER ROAD SECTOR MAP

4. MASTER DEVELOPMENT PLAN

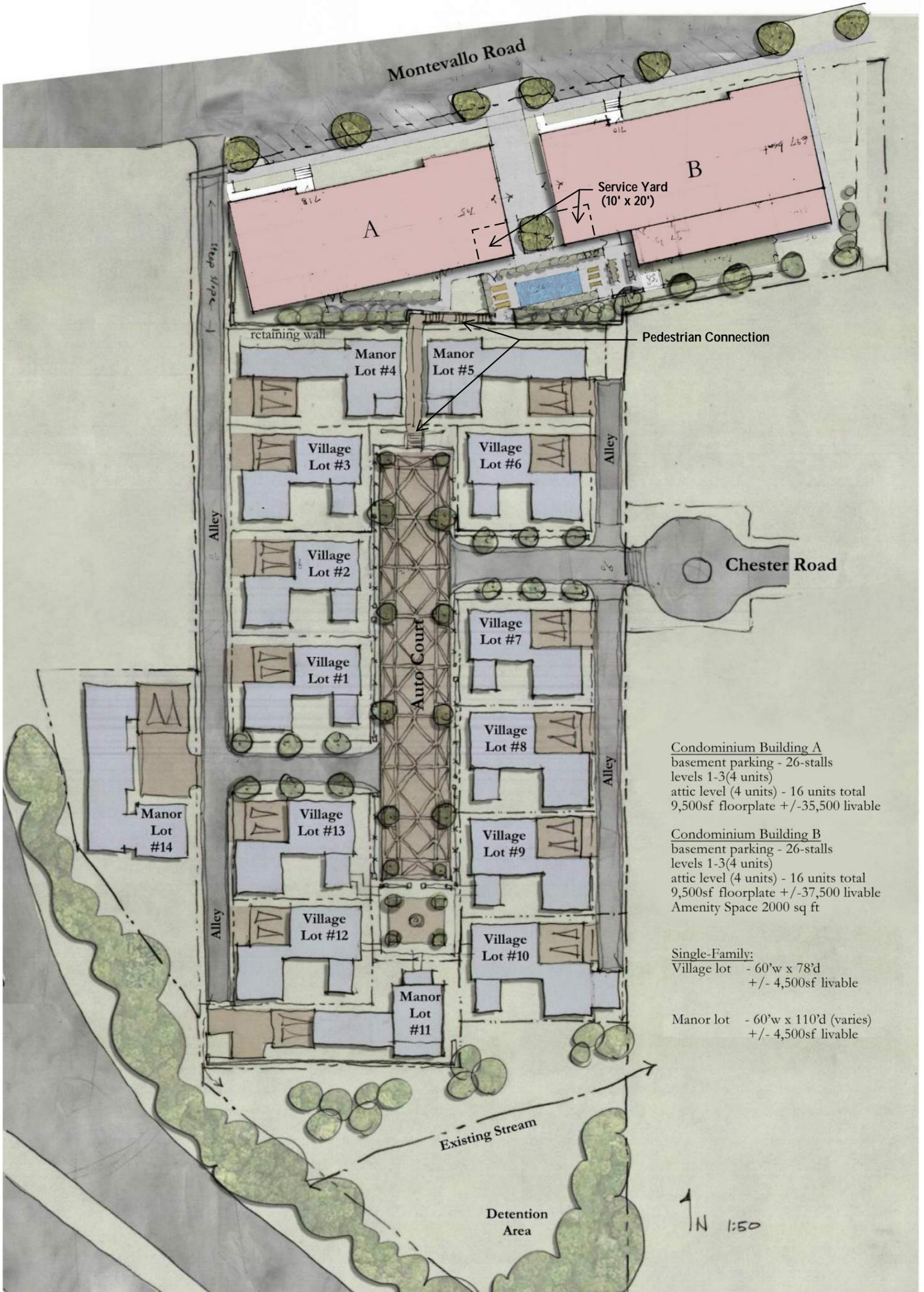

Condominium Building A
 basement parking - 26-stalls
 levels 1-3(4 units)
 attic level (4 units) - 16 units total
 9,500sf floorplate +/-35,500 livable

Condominium Building B
 basement parking - 26-stalls
 levels 1-3(4 units)
 attic level (4 units) - 16 units total
 9,500sf floorplate +/-37,500 livable
 Amenity Space 2000 sq ft

Single-Family:
 Village lot - 60'w x 78'd
 +/- 4,500sf livable

Manor lot - 60'w x 110'd (varies)
 +/- 4,500sf livable

5. LAND USE PLAN

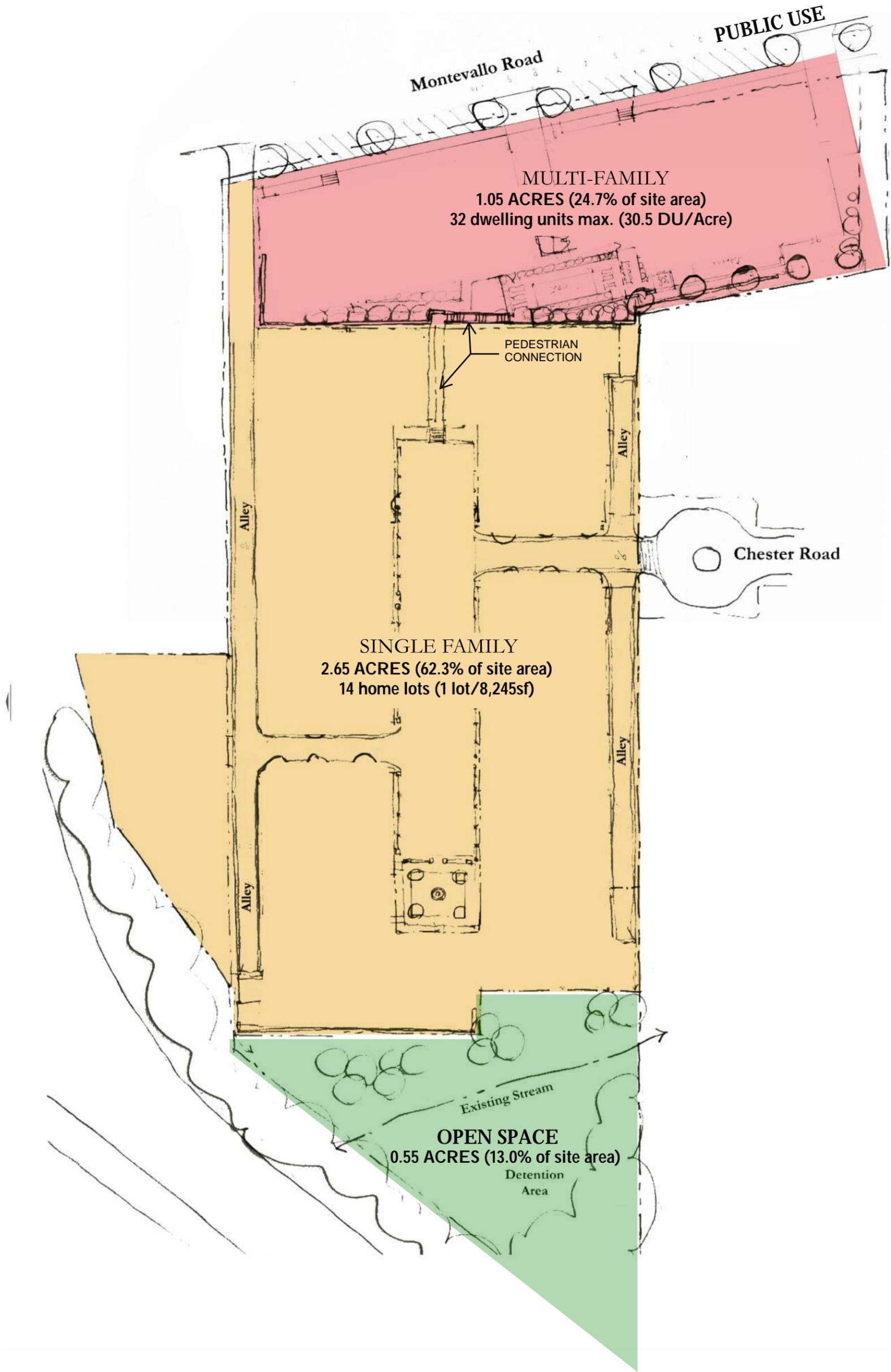

- MULTIFAMILY - APPROXIMATELY ONE ACRE CONTAINING 32 CONDOMINIUM UNITS AND 48 COVERED PARKING STALLS
- SINGLE-FAMILY - APPROXIMATELY TWO AND A QUARTER ACRES CONTAINING 14 CUSTOM HOME LOTS
- OPEN SPACE - APPROXIMATELY ONE-HALF ACRE

6. PERMITTED USES

Multifamily Use Area:

Within areas designated Multifamily Use Area, the following uses are permitted by right:

1. Residential dwelling units, provided however, the Multifamily Use Area shall not include more than thirty-two (32) residential dwelling units;
2. Enclosed garages and covered parking;
3. Sales offices;
4. Amenities, improvements, storage and mechanical uses ancillary to residential dwelling units, including but not limited to a pool, gym, laundry/cleaning services and recreational facilities;
5. Streets, rights of way, service roads, access ways and drive aisles (both public and private); and
6. Sidewalks and pedestrian passage ways.

Single family Use Area:

Within areas designated Single family Use Area, the following uses are permitted by right:

1. Residential dwelling units, provided however, the single family Use Area shall not include more than thirteen (14) residential lots;
2. Enclosed garages and covered parking;
3. Sales offices;
4. Amenities, improvements, storage and mechanical uses ancillary to residential dwelling units, including but not limited to a pool, gym, laundry/cleaning services and recreational facilities;
5. Streets, rights of way, service roads, access ways and drive aisles (both public and private); and
6. Sidewalks and pedestrian passage ways.

Open Space Use Area:

Within areas designated Open Space Use Area, the following uses are permitted by right:

1. Parks;
2. Playgrounds;
3. Green space;
4. Trails;

Public Use Area:

Within areas designated Public Use Area, the following uses are permitted by right:

1. Streets, rights of way, service roads, access ways and drive aisles (both public and private);
2. Sidewalks and pedestrian passage ways;
3. Special events, including festivals, parades, races, assemblies, gatherings and other events permitted under the City Code, provided such special events are sponsored and the sponsor thereof satisfies all requirements of the City Code with respect thereto.

7. OPEN SPACE & IMPERVIOUS SURFACE PLAN



Existing condition:

small green space fronting Montevallo with primary structure set back from street up against East boundary line. Large surface parking lot covering most of West side of property with preserved open space on south end.

Parking & Paving : 63,990 sf (1.47 acres)
 Building footprints: 15,507 sf (0.36 acres)
 Open space: 91,592 sf (2.01 acres)



Proposal:

Locating green space along the pedestrian streetscape on Montevallo Road. with largest structure fronting the street, providing a buffer between the street and residential uses. Parking in structure basement eliminates the large surface lot. Single family lots all self-park in rear-alley accessed garages. With the addition of private yards and a pervious paver system for the primary auto court, there would be a substantial reduction in impervious surfaces and stormwater runoff.

Parking & Paving : 16,922 sf (0.39 acres)
 Building footprints: 54,406 sf (1.25 acres)
 Open space: 113,802 sf (2.61 acres)

8. MULTIFAMILY ZONING DATA

Multifamily Zoning (Village Overlay - Stacked Flats Building Type; Residence G)			
	BASE ZONING DISTRICT	PROPOSED PLAN	CAUSE OF DEVIATION
Purpose	(a)General purposes. The village overlay standards are designed to:(1)Implement the village master plans, officially recommended by the planning commission as part of the overall master plan for the City of Mountain Brook and promote the health, safety, morals and general welfare of the community.(2)Provide for the kind, character and use of structures and improvements that may be erected or made within the villages, to promote and preserve the unique character and encourage pedestrian use of each of the villages.(3)Regulate the erection, construction, reconstruction, alteration, repair or use of buildings, structures or land subject to the standards, in conformance with the village master plan.(4)To permit differences in the height, mass, scale, design, type, and uses of buildings subject to the standards based on the relationship of sites to specific public streets, open spaces, and to surrounding parcels.(5)To allow coordinated development in the villages according to a comprehensive master plan that best complements the design and investment by the city in streets, open space and other public infrastructure.	Complies	None
Permitted Uses	(a)Uses. The uses permitted in areas subject to the village overlay standards are those authorized by the base zoning district for each parcel. (b)Building types. Stacked Flats building types are allowed on residential street frontage. Differences in size, placement, orientation and design of each building type are regulated by this article, and the applicable building and development regulating plan.	Complies	None
Stacked Flats building type			
Site Specifications			
Required lot width	60' minimum	Complies	None
Minimum lot depth	100'	Complies	None
Required front building line	<i>Between 22' & 26'</i>	from 30'-40' from Back of Curb on Montevallo Road.	This positions the West building between 22'&26' from the property line according to the Stacked Flats requirement and allows for a consistent street edge along the Montevallo frontage where the property line geometry does not match the street edge.
Front entrance extensions	An enhanced front entry may extend up to 8' beyond the constructed front building line of the building provided: (a) it occupies no more than 60% of the front façade (b) it remains unenclosed, with no fixed windows or screens. © any roof structure on or associated with is up to one and one-half stories; and (d) it is designed as an extension of the primary building using the same foundation, building materials, architectural styles, and ornamentation as the primary building.	Complies	None
Street Wall	between 65% and 100% of the street facing façade length	Complies	None
Minimum Side Setback	10% of the lot width or 10', whichever is less; except that 15' shall be required if more than 50% of the side lot line abuts a lot zoned for, or having and existing lower intensity residential use.	Complies	None
Minimum Rear Setback	20'	minimum of 20' for adjacent properties, minimum of 5'-0" for new internal property lines	Site will comply with perimeter property line setbacks to maintain existing requirements
Maximum lot coverage (footprint)	60% reduced by an additional Open Space requirement by Section 129-554 for residential uses.	Complies	None
Site access (vehicles)	Vehicle access limited according to street frontage type and as further specified in Section 129-555 (d) (1)Primary frontages. Vehicle access is prohibited except for one mid-block shared access area providing access to multiple lots within the block, and not to exceed 20 feet in width. All other vehicle access to individual lots shall be via alleys or off secondary, access, or support streets identified in the master plan.	Complies	None

8. MULTIFAMILY ZONING DATA

Multifamily Zoning (Village Overlay - Stacked Flats Building Type; Residence G)			
	BASE ZONING DISTRICT	PROPOSED PLAN	CAUSE OF DEVIATION
Mass and Height Specifications			
Maximum Height (external)	3-story: 36' to eaves/cornices plus roof structure (actual permitted stories for individual sites is controlled by the applicable Building and Development Regulating Plan)	Complies	None
Required Ground Floor Elevation	1.5' to 4' above grade at front building line	entry on high end to be 1.5' to 4' above grade at front building line	slope drops significantly across the length of building and setting high end of the building in this position will elevate low end well over the 4' cap.
1st story height	10' to 15'	Complies	None
Upper story heights (internal)	10' to 15'	Complies	None
Roof Structure heights	Steep Pitch (14:12 to 20:12) 16' maximum provided that no building shall exceed 46 feet in height Pitched roof structures may have additional floor areas which may be occupied without counting towards the story maximum for purposes of the applicable building and development regulating plan, provided the additional floor area is: (a) associated with and accessory to the floor area of the top story and (b) limited so that the areas with clear ceiling height of 7'-0" or more is no more than 50% of the floor area of the story immediately below.	maximum of 16' in roof height and maximum of 49' in building height from level 1 finished floor elevation minus distance to grade at primary entry . Occupied attic area are proposed units similar to but independent of level below with a maximum of 75% of floor area of story below.	slope drops significantly across the length of building and total height of structure will vary if measured from natural grade. All units in this develop are intended to target an empty nester demographic and, consequently re all designed as single-level living units.
Façade Specifications			
First Story Transparency	15-40%	Complies	None
Upper Story Transparency	15-40%	Complies	None
Primary Entrance	1 Enhanced Primary Entrance for each building	Complies	None
Bays	Differentiated bays are required a minimum of every 25' and a maximum of every 50'	Complies	None
Façade Projections	Bay windows and balconies may extend up to 5' from the façade	Complies	None
Building height exceptions	(2)Ornamental features. A height exception may be permitted for ornamental features on all buildings where such features do not exceed an additional six feet in height and where said feature is limited to the following: spires, chimneys, chimney pots, flag poles, and weather vanes.	Ornamental features to be limited to an additional 10'-0" in height	to best agree with the form and scale of the primary building massing
Open Space Standards	Standards. Lots shall contain public or quasi-public open space in addition to open space created implicitly by the operation of setbacks, maximum lot coverage or other building regulations. The required open space shall be based upon the type of use and building type and mass based upon the following table. The required open space shall be in addition to any required setbacks for the lot and building type, and must occur within the otherwise allowable building footprint. Open space required for townhouse or stacked flat building types may be located at any location within the otherwise allowable building footprint. Open space must be functional and should utilize the design guidelines for open space in the village master plans, but may not consist of parking areas, service areas or site utility areas. [refer to section 5.4, Open Space Design, of the Design Guidelines of the Village Master Plan for specific strategies for open space design]. Residential Uses require 100sf of open space per dwelling unit.	Complies	None

8. MULTIFAMILY ZONING DATA

Multifamily Zoning (Village Overlay - Stacked Flats Building Type; Residence G)			
	BASE ZONING DISTRICT	PROPOSED PLAN	CAUSE OF DEVIATION
Parking, vehicle, and pedestrian access standards			
Required parking	<p>By base zoning regulations (Residence G) (1)Minimum offstreet parking per dwelling unit: Two spaces.</p> <p>a.Exception: Projects over 20 dwelling units, and which may have a substantial mix of dwelling units which could be designed for families with fewer than two vehicles may propose an alternative parking ratio. The proposal for a reduced rate shall be based on demonstrated and convincing market and demographic data regarding the parking demand per each dwelling type included in the mix. Approval of an alternative ratio is in the sole discretion of the city council, based on a recommendation of the planning commission.(2)Visitor and accessory parking shall be provided based on the following:</p> <p>Eleven or more units: Five spaces plus one-fourth additional parking space for each unit over ten;</p> <p>(3)Any offstreet surface parking, interior parking or parking structures for the dwelling units and for visitor or accessory parking shall meet the parking design and vehicle access limitations of the village overlay standards.</p>	1.5 stalls per unit	<p>Parking is in line with market rate product and above the market based on the target demographic. Parking beneath building is intended to completely meet the requirements for the residential units. 16 units / 24 parking stalls = 1.5 stalls / unit. The street parking would serve as visitor parking. Per base zoning, 5+5.5 = 10.5 stalls required, 13 stalls provided.</p>
Vehicle access limitations	<p>Vehicle access to all lots subject to the village overlay standards shall be limited according to frontage type indicated on the applicable building and development regulating plan based upon the following standards:(1)Primary frontages. Vehicle access is prohibited except for one mid-block shared access area providing access to multiple lots within the block, and not to exceed 20 feet in width. All other vehicle access to individual lots shall be via alleys or off secondary, access, or support streets identified in the master plan.</p>	Complies	None
Sidewalk standards	<p>Any development fronting on streets that do not currently have sidewalks shall include sidewalks in association with the site development according to the following:(1)Sidewalks on primary village street designated in the Circulation and Urban Design Plan of the Village Master Plan, adopted June 2007, shall be between eight-foot and 12-foot wide.</p>	Complies	None
Material specifications		See Pattern Book	

SINGLE-FAMILY ZONING (RESIDENTIAL INFILL DISTRICT BASE)			
	BASE ZONING DISTRICT	PROPOSED PLAN	CAUSE OF DEVIATION
Purpose	The residential infill district is an "overlay" district that is designed to promote the highest and best use of residential real estate by permitting the cost-effective development or redevelopment of residential property in limited areas within the city, under carefully controlled conditions, and in ways that will serve the purpose of the zoning ordinance without compromising the unique character of the residential districts within the city. (1)To permit additional, high-quality residential land use and development options for "transitional" zones between existing commercial and/or business uses and residential districts, the effect of which would be to maintain the residential character of existing residential districts while simultaneously discouraging objectionable nonresidential encroachment into such districts;	Complies	None
Permitted Uses	(a) Detached single-family dwellings. (b) Accessory structures; accessory buildings customarily incidental to residential occupancy; provided, that no accessory building may be used as a dwelling, or occupied by any person, either on a long-term or temporary basis; further provided, that such prohibition shall not apply to any accessory building which was designed for human habitation and was in existence or in the process of construction on June 28, 1993; (c) Gardens and greenhouses customarily incidental to residential occupancy; provided, that the products grown there may not be sold on the premises.	Complies	None
Area & dimensional requirements			
Max. Density	Regarding the development taken as a whole, the average lot size shall be 6,000 square feet of land area; however, the city may require lower densities to achieve compatibility with the nature, density, and character of surrounding property.	Complies	None
Minimum Yards	(c) Minimum yards, setbacks, and building separation: No structure shall be located closer than ten feet from any adjacent residential property; provided, however, that the city may require additional setback area, buffers, greenbelts, or other landscape feature to achieve compatibility with the nature, density, and character of surrounding property. All buildings shall be located so as to conform to the Southern Standard Building Code and the Standard Fire Prevention Code, both as may be adopted and amended by the city.	Minimum setbacks will be 5' from lot lines, which would provide a minimum of 10' between buildings	In order to present a more urban and compact street , the lots and setbacks will be reduced
Min. Lot Frontage	(d)Minimum lot frontage on a public street: None; however, all lots shall either adjoin a public street or have access to a public street via a recorded easement or a private right-of-way.	Complies	None
Max Building Ht.	(e)Maximum building height: Two and one-half stories or 37½ feet, provided that a lower building height may be mandated in order to achieve the purposes of this article.	Complies	None
Streets	All proposed public streets and improvements shall meet or exceed the minimum standards established by the Mountain Brook subdivision regulations. The city shall determine whether private streets or roadways are appropriate for the proposed development, based upon its master development plan review, considering the size of the development, density, relationship to the surrounding area, and public safety.	On site streets would be private but built to meet City of Mountain Brook emergency access requirements. On site alleys would be private and not intended for city access / use.	The primary vehicular court is envisioned to be a plaza and covered in a decorative / patterned paver in order to meet the aesthetic goals of the development. This material is traffic-rated but non-standard for a street surface and the maintenance and ownership would sensibly be the burden of the HOA.
Off street Parking	Driveways, parking areas, and related improvements shall be privately owned. Convenient offstreet parking shall be provided for all dwelling units. All parking spaces, driveways, and other areas necessary for the maneuvering of motor vehicles shall be arranged so as to provide convenient access to a paved street or alley. Sidewalks, parking spaces, driveways, and maneuvering areas shall be paved and shall have adequate storm drainage facilities. All driveways, parking areas, and steps shall be adequately lighted.	Complies	None
Additional Requirements	(a)Utilities. All utility lines shall be placed underground.	Complies	None
	(b)Fire protection. All buildings or structures must be located no farther from a fire hydrant than may be reached with 500 feet of hose.	Complies	None
	(c)Separate ownership. Each dwelling shall be situated on a separate lot, unless the development is a condominium which use shall be permitted in the residential infill district.	Complies	None
	(d)Title to property. All common areas, such as private streets, driveways, parks, recreational facilities, planted or forested areas, and all other improved or unimproved real property and improvements shall be privately owned, and title thereto may be held by a trustee for the benefit of the residents of such development, by a private corporation, by an association of the residents thereof, or as undivided interests owned by the owners of the lots within such development. Such trustee, corporation, association, or owners (jointly and severally) shall be responsible for the proper care and maintenance of such streets and other property and improvements.	Complies	None
	(e)Documentation of maintenance of improvements. Prior to final plat approval of a subdivision for a residential infill development, the developer shall submit to the city clerk appropriate legal documents that provide for adequate maintenance of private streets and driveways, parks, recreational facilities, planted or forested areas, and all other improved or unimproved real property and improvements located within the common areas.	Complies	None

9. PATTERN BOOK

MULTIFAMILY USE ZONE

Lot Layout notes:

- see zoning comparisons for lot layout requirements.

SINGLE FAMILY USE ZONE

Lot Layout notes:

- see zoning comparisons for lot layout requirements.
- There is no minimum or maximum required lot depth.
- There is no minimum or maximum required lot width.
- Maximum lot coverage is 65% of the buildable area. Pedestrian and vehicular circulation shall not count against the lot coverage.
- Side setbacks between buildings are a minimum of 10' (5' each side of property line), provided building code separation requirements are met.
- All references to a lot or depictions of a lot line shall refer to a Parcel or the boundary line of such Parcel.
- Lot layout example is shown for design intent and does not represent a prescriptive answer for the building design. Building designs will be the responsibility of the lot owner.

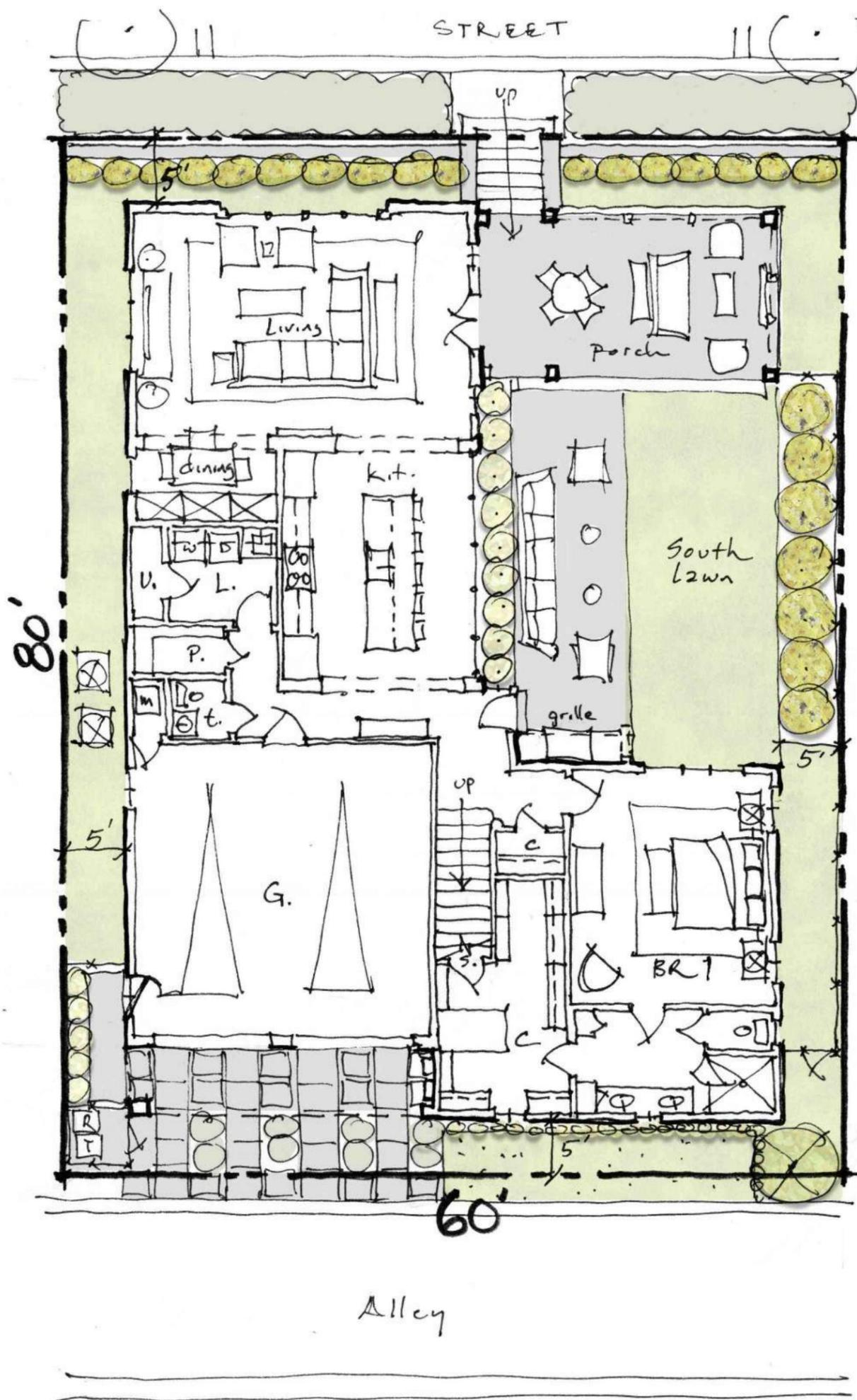

9. PATTERN BOOK

ARCHITECTURAL STYLES

The British Arts & Crafts Movement:

The British Arts and Crafts Movement- (1880-1920)- it was a revolution in the decorative and fine arts that focused on clean, simple lines in architecture, furniture and other decorative arts. It centered around a belief in craftsmanship, the inherent beauty of a material, importance of nature as inspiration, and the value of simplicity, utility and beauty.

Started by Augustus Pugin, William Morris and John Ruskin.

Notable Architects include C.F.A. Voysey, Edwin Lutyens, M.H. Baillie Scott, Charles Rennie Mackintosh to name a few.

Most Common: The English Farmhouse/Cottage

- These houses were influenced and inspired by English vernacular sources of the 16th and 17th centuries (i.e. the English Farmhouse). They used simple palettes of local materials:
- British Arts and Crafts was based on elements of vernacular architecture: white washed walls, steep slate roofs, sandstone mullions and double chimney stacks. All evoke Lakeland farmhouse architecture of the 16th and 17th centuries.
- Most Exterior walls are red masonry brick, stone or roughcast (heavy textured stucco)
- Roof were predominantly steep pitched and used clay or slate tile roofs
- Windows were predominantly steel and often ganged together in horizontal ribbons with stone surrounds.
- Emphasis on natural materials, honest use and connection back to nature.



9. PATTERN BOOK

ARCHITECTURAL STYLES

The British Arts & Crafts Movement:

Key Exterior Elements:

- Steep Roofs with smaller projected hipped or shed roofs
- Exposed roof rafter tails
- Simplified decorative beams or brackets under gables
- Tapered Buttresses
- Horizontal shape
- Ganged exterior windows/corner windows (Emphasize the horizontal)
- Punched windows
- Equally divided window lites
- Porch support bases extending to ground level
- Wood, stone or stucco siding
- Exterior brick, stucco(roughcast) and stone combinations
- Earth-tone exterior paint and stain colors

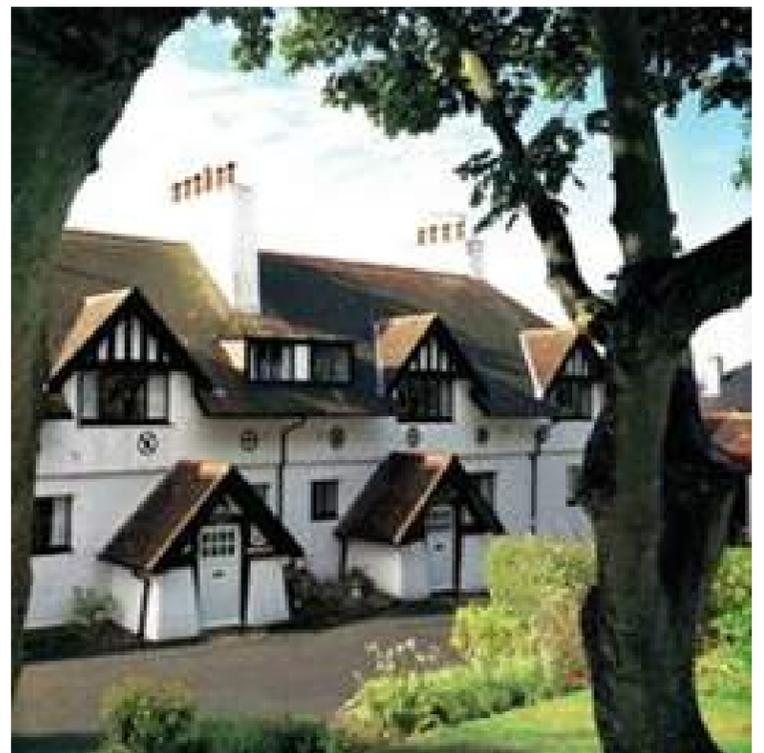

9. PATTERN BOOK

ARCHITECTURAL STYLES

The British Arts & Crafts Movement:

Exterior Materials:

- British A&C Houses typically have exteriors with
- Lime washed stone or brick masonry,
- Stone masonry with brick accents or roughcast stucco.
- Gable ends and infill areas at windows or doors are horizontal wood T&G.
- Chimney flues are typically stucco over masonry, stone or brick masonry with simple cap (or corbelling) with clay chimney pots.
- Roofing materials can be clay tile, wood shake roofing, copper soldered flat seam roofing or slate.



9. PATTERN BOOK

ARCHITECTURAL STYLES

The British Arts & Crafts Movement:

Exterior Windows:

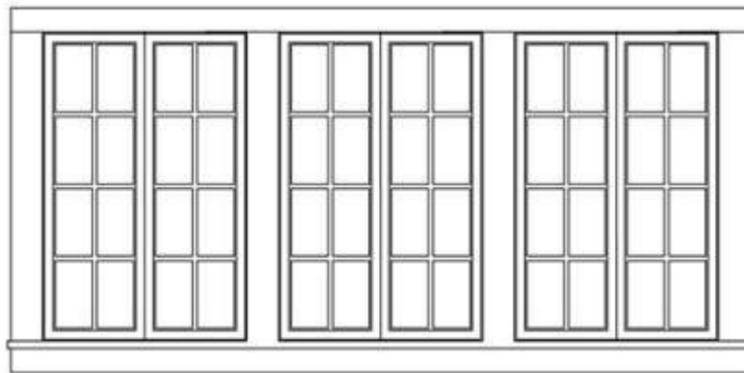
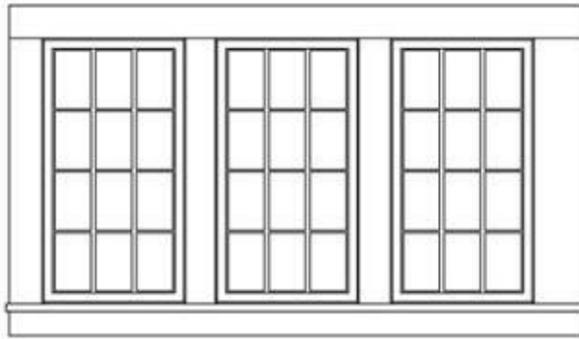
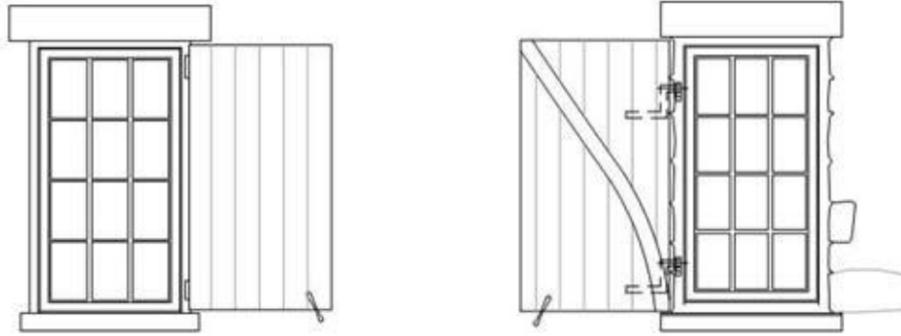

9. PATTERN BOOK

ARCHITECTURAL STYLES

The British Arts & Crafts Movement:

Exterior Doors:



Organic

Median

Refined



9. PATTERN BOOK

ARCHITECTURAL STYLES

The British Arts & Crafts Movement:

Exterior Porches and Brackets:

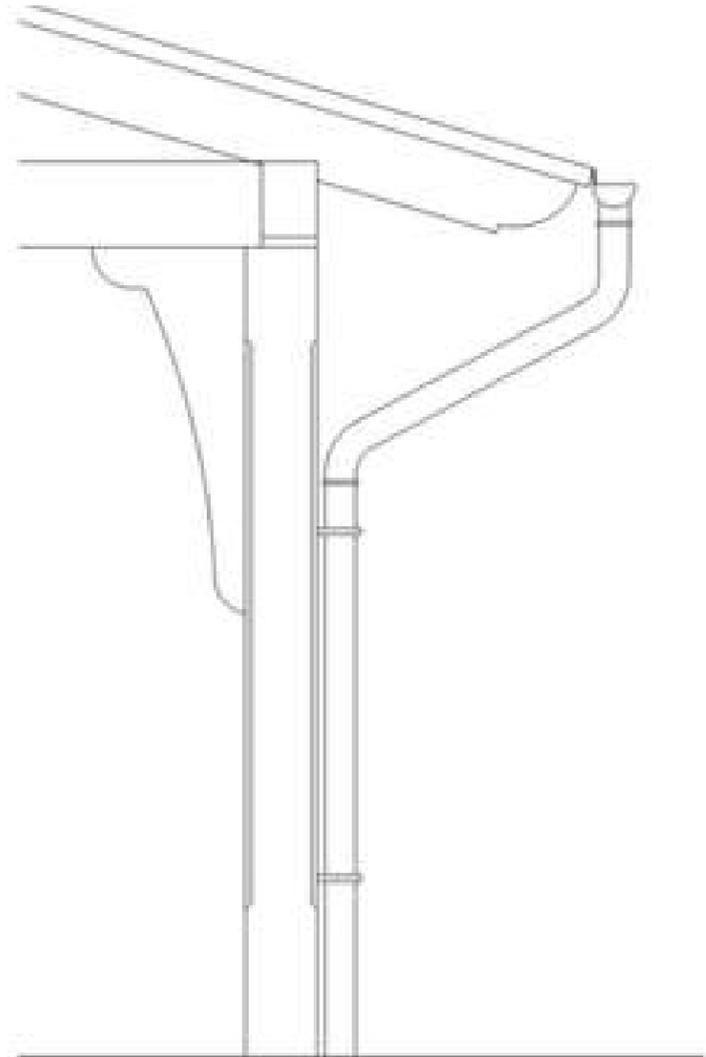

9. PATTERN BOOK

ARCHITECTURAL STYLES

The British Arts & Crafts Movement:

Roughcast & Piers:

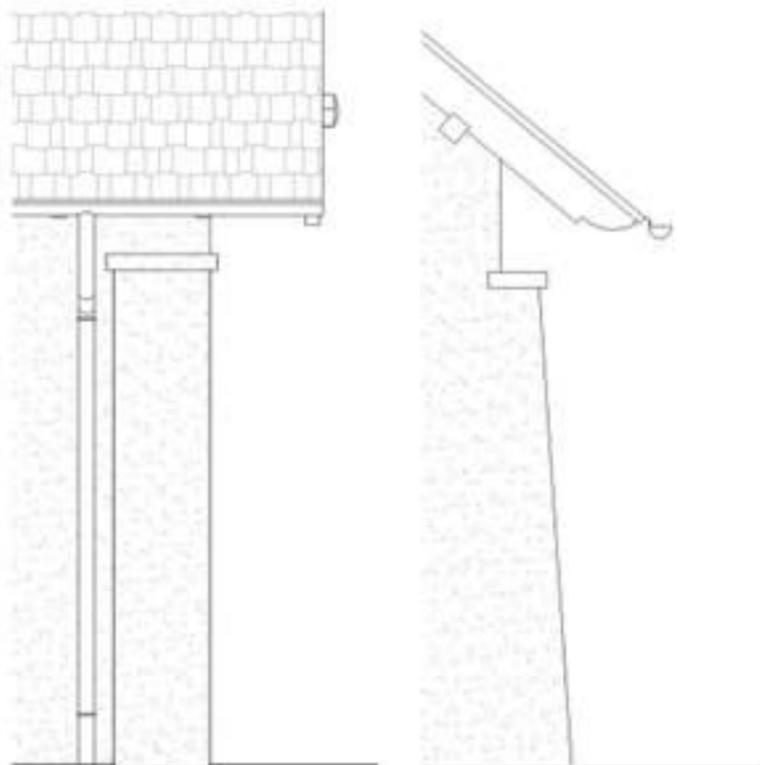

9. PATTERN BOOK

ARCHITECTURAL STYLES

The British Arts & Crafts Movement:

Dormers:



9. PATTERN BOOK

ARCHITECTURAL STYLES

The British Arts & Crafts Movement:

Exterior Lighting:

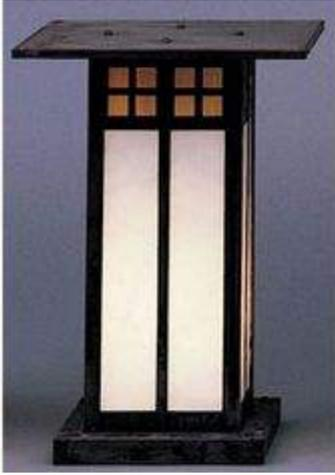

9. PATTERN BOOK

ARCHITECTURAL STYLES

The English Tudor Revival Style:

English Tudor Revival Style- Tudor Revival architecture first manifested itself in domestic architecture in the United Kingdom in the latter half of the 19th century. Based on revival of aspects that were perceived as Tudor architecture, in reality it usually took the style of English vernacular architecture of the Middle Ages that had survived into the Tudor period. The style later became an influence elsewhere, especially the British colonies. It was associated with the Arts and Crafts movement.

Largely forgotten for three centuries, the Tudor style reappeared in the United States in the early 1900s but built using the same wood-framing methods used to construct other homes of the era. Americans embraced the Tudor style, building new homes that blended some of the old-world design elements with modern home-building techniques. The Tudor Revival Style has many alternate labels: Elizabethan, Jacobean, Queene Anne & Cotswold.

Cousins of the Stick-style house, Tudor Revivals eschewed authentic half-timber construction and often featured brick or stone walls on the first story, and upper floors that were stud-framed and covered with a veneer of stucco and decorative faux timbers. Cross gables were commonly included in the plans, as were typically Tudor features like steep rooflines and gabled windows with leaded-glass mullions. The traditional thatched roof, however, was replaced by slate. They typically had clustered chimney stacks of stone and brick. Interiors incorporated such Tudor-style elements as decorative beamed ceilings, arched doorways, plaster walls, and detailed wooden staircase.

Common Characteristics:

- Decorative Half-Timbering
- Use of Mixed Building Materials
- Large Groupings of Windows
- Attention to Detail in the Entrance
- Steeply pitched roofs and multiple gables.
- Two or three stories high.
- Rectangular design.
- Half-timbered exterior façade used in conjunction with stucco or decorative brickwork.
- Cantilevered (overhanging) second story extending over a large porch.
- Tall windows with multiple square- or diamond-shaped panes; some are leaded glass.
- Tall ornate brick chimneys.
- Chunky iron door ware that lends a Medieval look.
- Earth-tone cladding colors (tan, brown, buff).
- Asymmetrical floor plans.
- Interiors with (faux) exposed ceiling beams overhead.
- Oversized, stained wood detailing, including wainscoting and trim.
- Jetties, or overhangs formed when the second floor extends beyond the dimensions of the first (a feature made popular in cities where the first-floor footprint was limited by the street outside.)

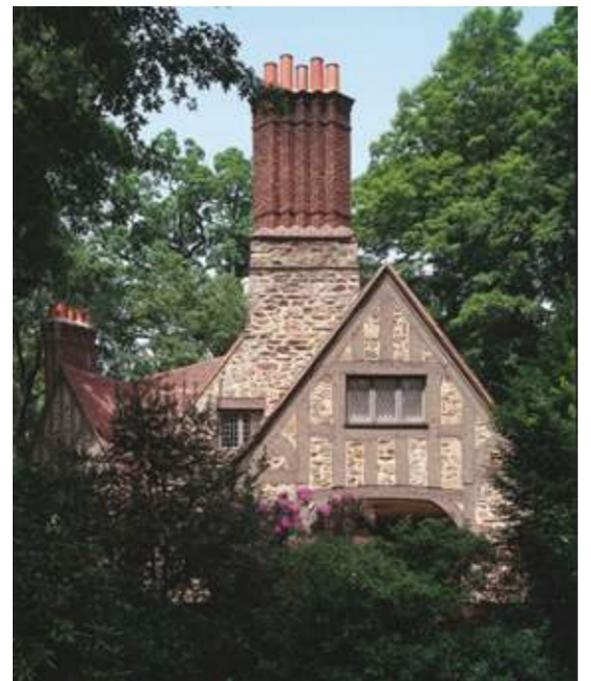

9. PATTERN BOOK

ARCHITECTURAL STYLES

The English Tudor Revival Style:

Key Exterior Elements:

- Low pitched, gabled secondary roof forms (occasionally hipped) with wide unenclosed eave overhang
- Exposed roof rafter tails
- Simplified decorative beams or brackets under gables
- One and half stories for entry porches and secondary volumes
- Horizontal shape
- Porch with thick square or tapered columns
- Porch support bases extending to ground level
- Wood, stone or stucco siding
- Chimney expressed on the exterior wall
- Earth-tone exterior paint and stain colors



9. PATTERN BOOK

ARCHITECTURAL STYLES

The English Tudor Revival Style:

Chimneys:



Exterior windows:



9. PATTERN BOOK

ARCHITECTURAL STYLES

The English Tudor Revival Style:

Exterior Windows:

Organic



Median

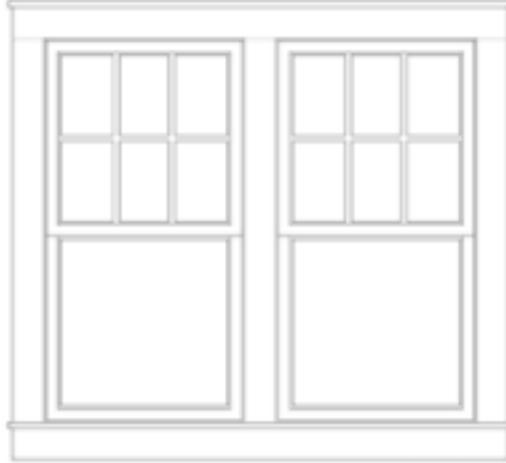

Refined



Exterior Doors:

Organic



Median



Refined

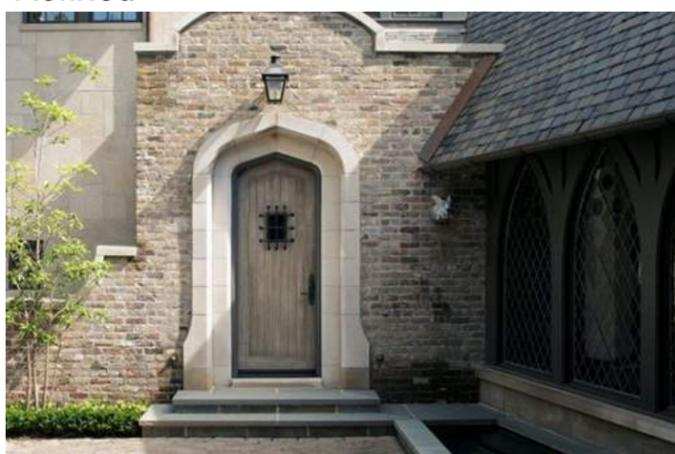

9. PATTERN BOOK

ARCHITECTURAL STYLES

The English Tudor Revival Style:

Exterior Porches and Brackets:

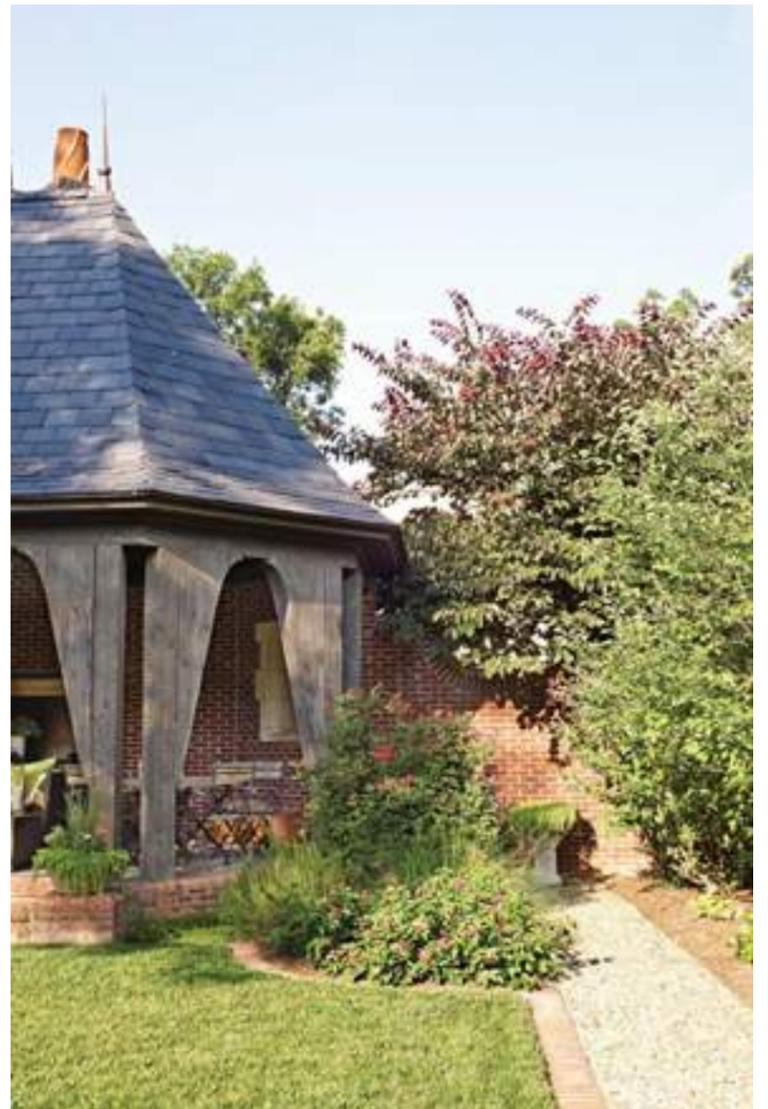

9. PATTERN BOOK

ARCHITECTURAL STYLES

The English Tudor Revival Style:

Exterior Lighting:



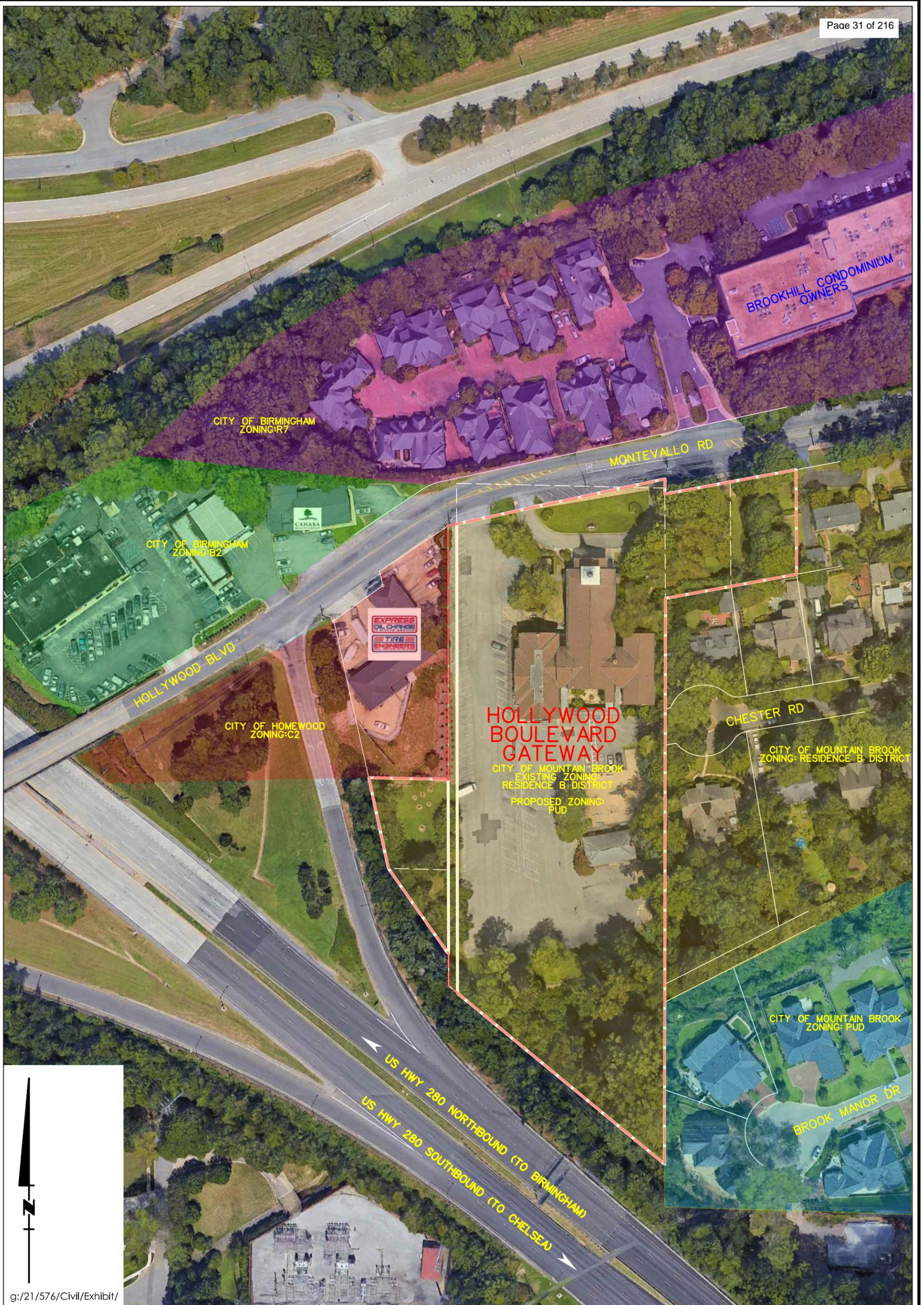

g:/21/576/Civil/Exhibit/

VICINITY MAP HOLLYWOOD BOULEVARD GATEWAY

DATE: JUNE 09, 2022
SCALE: 1"=60'

Copyright © 2022 School Engineering Company, Inc.

Civil Engineering | Land Surveying | Landscape Architecture
Environmental | Water Resources | Laser Scanning + Modeling



1001 22nd Street South | 7500 Memorial Pkwy SW, Ste 209
Birmingham, Alabama 35205 | Huntsville, Alabama 35802
205.323.6166 | 256.539.1221

SCHOEL.COM

11. SURVEY

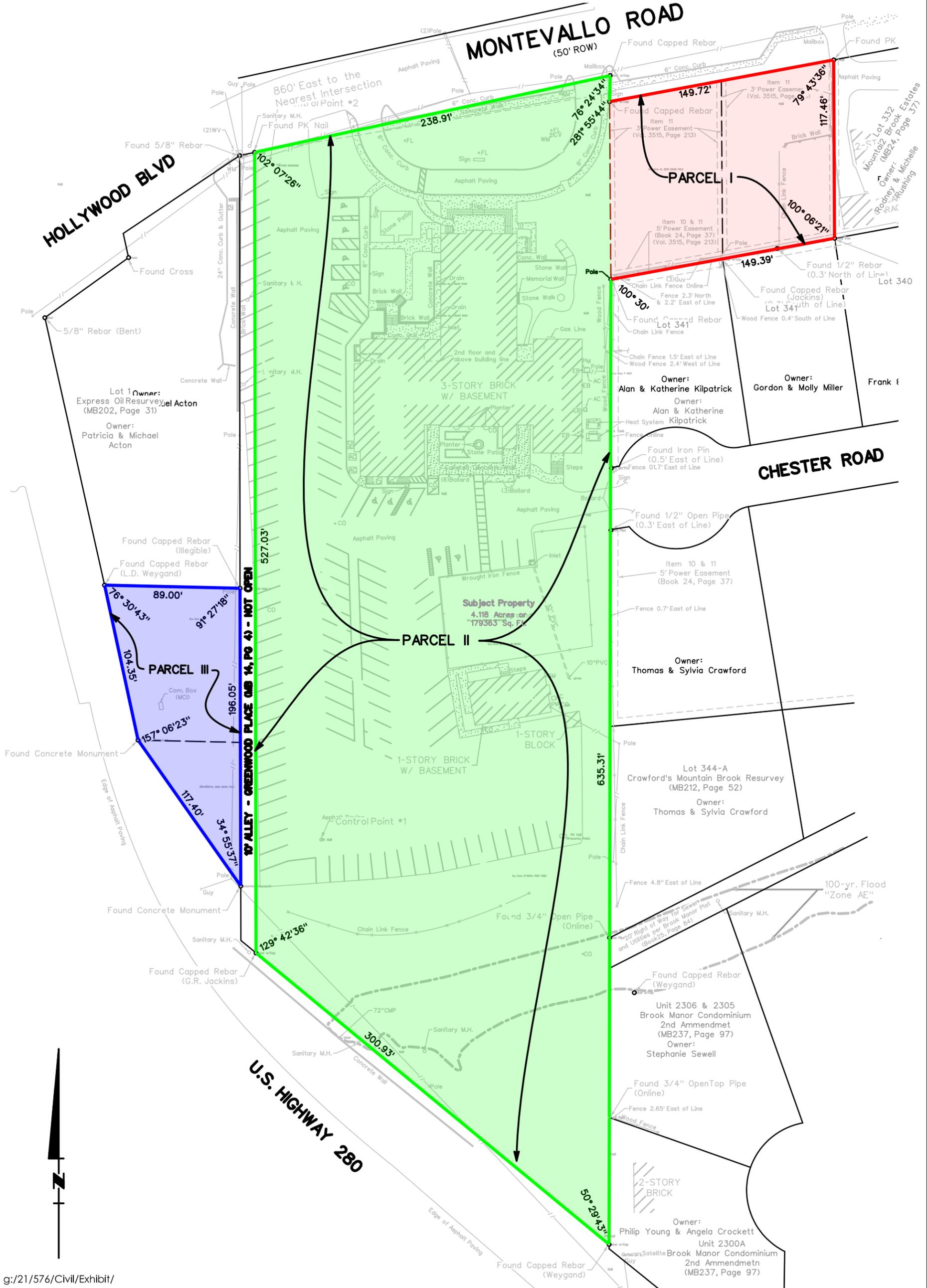

g:/21/576/Civil/Exhibit/

PERIMETER SURVEY HOLLYWOOD BOULEVARD GATEWAY

DATE: JUNE 09, 2022
SCALE: 1"=60'

Civil Engineering | Land Surveying | Landscape Architecture
Environmental | Water Resources | Laser Scanning + Modeling



1001 22nd Street South | 7500 Memorial Pkwy SW, Ste 209
Birmingham, Alabama 35205 | Huntsville, Alabama 35802
205.323.6166 | 256.539.1221

SCHOEL.COM

12. GRADING & DRAINAGE

-  LOAD RATED HARDSCAPE
-  ASPHALT PAVING
-  CONCRETE DRIVEWAY
-  CONCRETE SIDEWALK

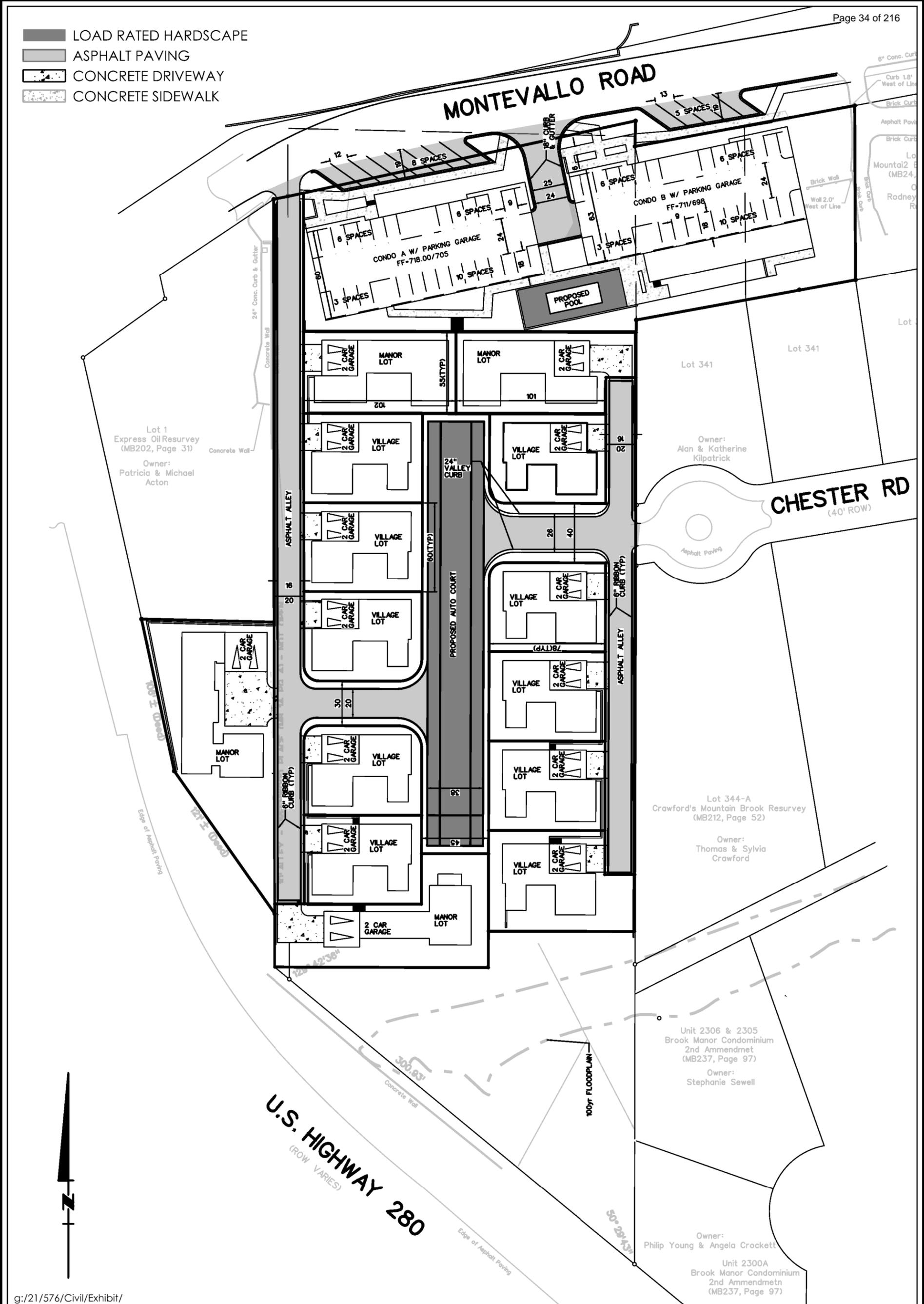

g:/21/576/Civil/Exhibit/

SITE LAYOUT PLAN HOLLYWOOD BOULEVARD GATEWAY

DATE: JUNE 09, 2022
SCALE: 1"=60'

Civil Engineering | Land Surveying | Landscape Architecture
Environmental | Water Resources | Laser Scanning+Modeling



1001 22nd Street South | 7500 Memorial Pkwy SW, Ste 209
Birmingham, Alabama 35205 | Huntsville, Alabama 35802
205.323.6166 | 256.539.1221

SCHODEL.COM

13. LEGAL DESCRIPTIONS

LEGAL DESCRIPTIONS

PARCEL I:

Lots 330 and 331, according to the Survey of Mountain Brook Estates, Chester Road, as recorded in Map Book 24, page 37, in the Probate Office of Jefferson County, Alabama.

+/- 17,256 Square Feet or 0.4 Acres

PARCEL II:

Begin at the center of the North boundary line of the NW 1/4 of the SW 1/4 of Section 8, Township 18, Range 2 West; thence run South along the center line of said NW 1/4 of SW 1/4 790 feet; thence East and parallel with the North boundary line of the said NW 1/4 of SW 1/4 234 feet; thence North 790 feet to the North boundary line of said 40 acre tract; thence West along the said North boundary line 234 feet to Point of Beginning.

LESS AND EXCEPT any portion of subject property lying US Highway 280. Situated in Jefferson County, Alabama.

+/- 151,035.66 Square Feet or 3.5 Acres

PARCEL III:

A part of Lots 9 and 10, according to the survey of the Greenwood Place Subdivision, the map or plat of which is recorded in Map Book 14, page 4 in the Office of the Judge of Probate of Jefferson County, Alabama and being more fully described as follows:

Beginning at the Southeast corner of said Lot 9; thence Westerly along the South line of said Lot 9 a distance of 1 foot, more or less, to a point that is 140 feet Northeasterly of and at right angles to the centerline of Project No. F-214(4); thence Northwesterly along a straight line a distance of 121 feet, more or less, to a point that is 178 feet Northeasterly of and at right angles to the centerline of said project at Station 207+83; thence Northwesterly along a straight line (which if extended would intersect a point that is 240 feet Northeasterly of and at right angles to the centerline of said project at Station 200+73) a distance of 106 feet, more or less, to the North line of said Lot 10; thence Easterly along the North line of said Lot 10 a distance of 90 feet, more or less, to the East line of said Lot 10; thence Southerly along the East line of said Lots 10 and 9 a distance of 200 feet to the Point of Beginning.

+/- 11,104.31 Square Feet or 0.3 Acres

g:/21/576/Civil/Exhibit/

SURVEY LEGAL DESCRIPTIONS HOLLYWOOD BOULEVARD GATEWAY

DATE: JUNE 09, 2022
SCALE: 1"=60'

Copyright © 2022 Schoel Engineering Company, Inc.

Civil Engineering | Land Surveying | Landscape Architecture
Environmental | Water Resources | Laser Scanning + Modeling

SCHOEL

1001 22nd Street South | 7500 Memorial Pkwy SW, Ste 209
Birmingham, Alabama 35205 | Huntsville, Alabama 35802
205.323.6166 | 256.539.1221

SCHOEL.COM



HOLLYWOOD BOULEVARD GATEWAY LOOKING EAST



MONTEVALLO ROAD LOOKING WEST



EAST ELEVATION OF CONDO A

APPENDIX C
3-D MODEL IMAGES

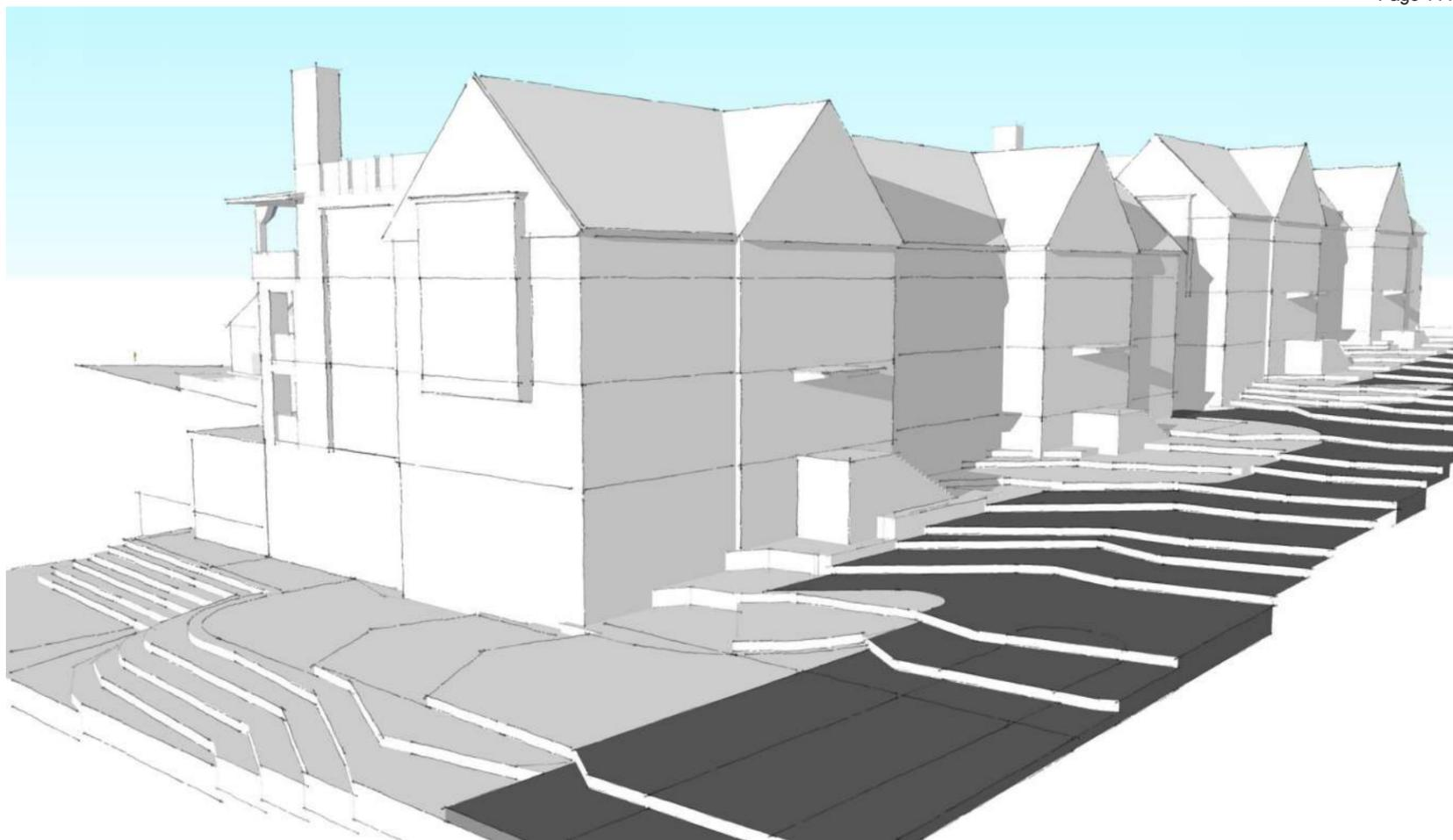

LOOKING WEST ON MONTEVALLO ROAD

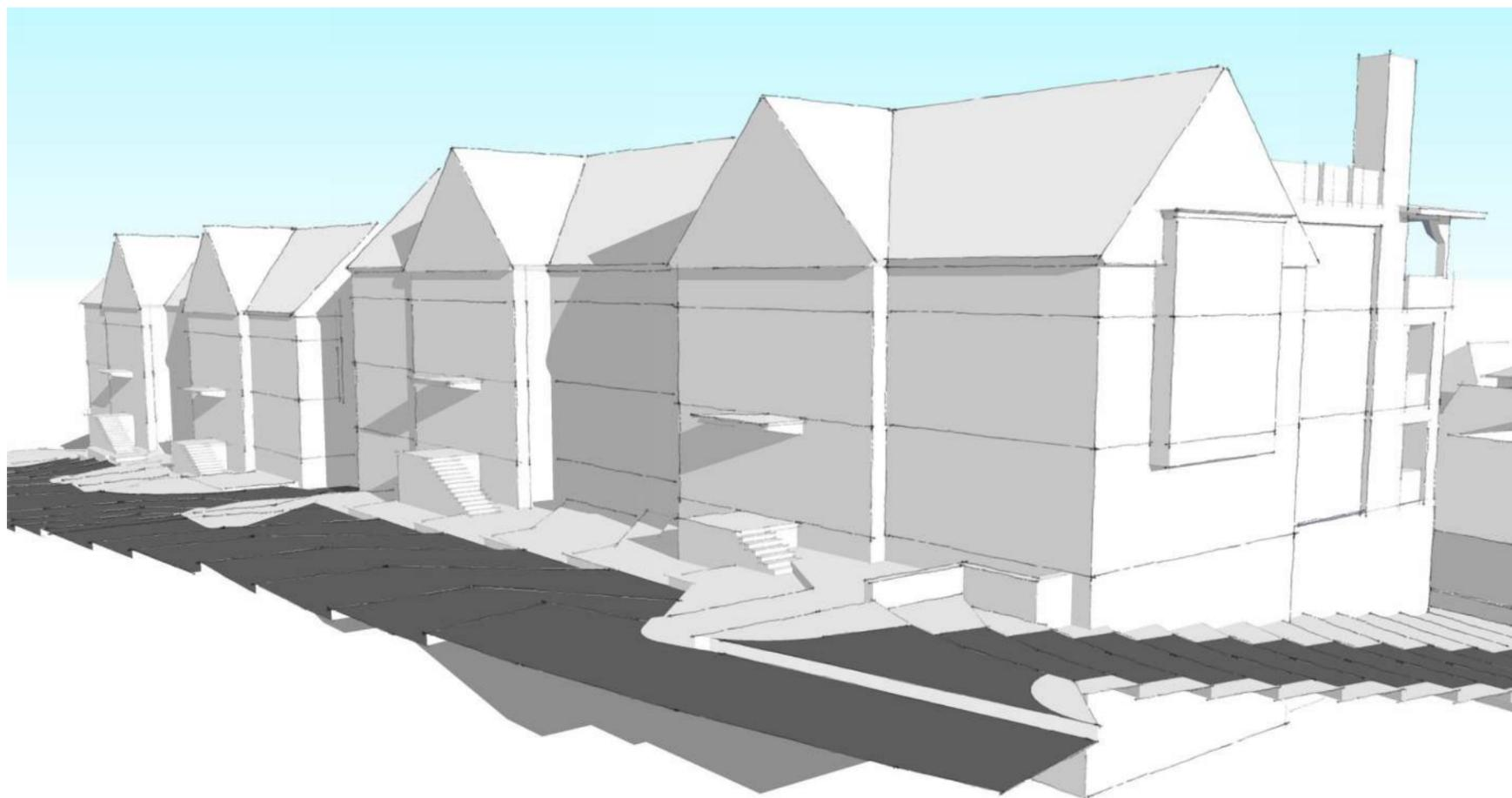

LOOKING EAST ON MONTEVALLO ROAD



LOOKING WEST ON SINGLE FAMILY

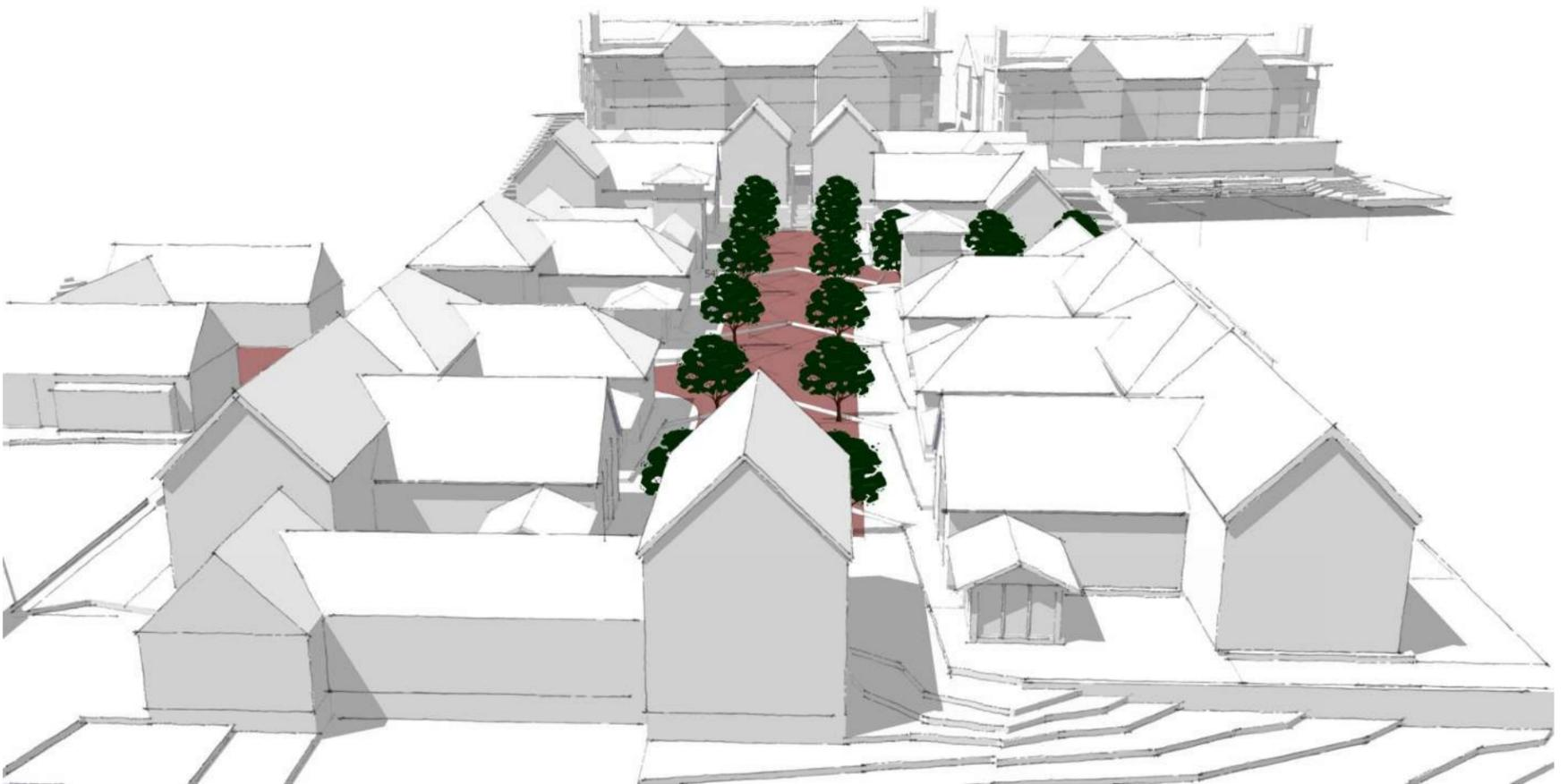

SINGLE FAMILY FROM SOUTH



LOOKING NORTHWEST FROM CHESTER ROAD



TOWARDS MONTEVALLO ROAD FROM CHESTER ROAD

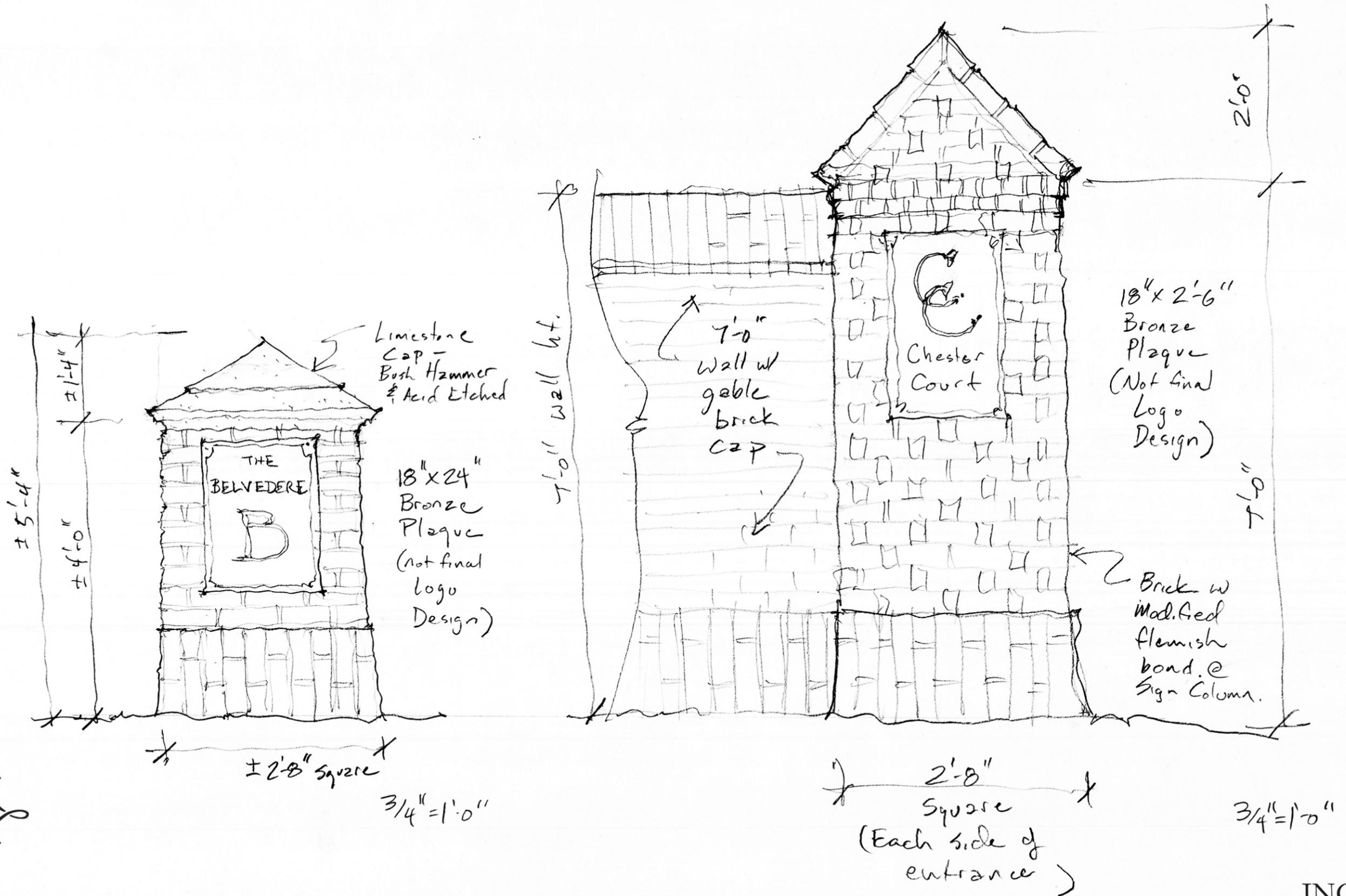

Statement of Intent

The Developer intends to develop the site in both Single Family Detached and Condominium residences all of which will be sold. It is the intention to fully develop the site and no portions of the site would be developed in the future besides the improvements indicated on the site plan submitted with this application.

Mortgage holder – THERE IS CURRENTLY NO MORTGAGE HOLDER ON THE PROPERTY

RS Mountain Brook Estates Inc (Seal) WD
By Robt Jemison Jr, Pres.
Bham Attest; A B Tanner, Sec. D 17 May 1944
Vol 3515 To F 1 June 1944
Pg 213 Frank J Hughes, C \$100 and
other good and
val cons Pd.

CONVEYS:

The foll desc r e sit in the City of Mountain Brook JCA
to-wit;

Estates Numbers 330, 331 and 332, Chester Road Sector of
Mountain Brook Estates, acdg to map and survey of sd sector of
Mountain Brook Estates made by Mountain Brook Estates Inc and
recorded in map book 24 at page 37, in the Off of the Judge of
Probate of JCA.

This conveyance is subj to the provisions of instrument executed
by Mountain Brook Estates Inc., dated May 23 1940 and recorded
in vol 3086 pg 466 in the Off of the Judge of Probate of JCA.

Mtn
Brk
#2

There is excepted from this conveyance and reserved to the grantor, its successors and assigns an easement Five ft in width along the rear prop line of sd prop for electric light and telephone poles and lines or other public utilities; also an easement 3 ft wide on the side lines of sd prop for telephone and electric lines to a point distant 150 ft from the front line of sd prop. The right is also reserved to anchor guy lines on sd estate whenever the same may become nec for the erecting of telephone or electric light poles on the easement provided therefor. 213

There is also exc from this conveyance and reserved to the sd grantor, its agents, succs or assigns, or to the agents of any public utility, the right of ingress and egress to and from sd prop for all nec purposes in connection with the installation and maintenance of any public utilities on and over such easements.

This conveyance is made subj to the foll conditions, limitations and restrictions, as to each of sd estates separately & severally viz

- (1) That sd prop shall be used by white persons only, exc that any servant or servants employed on the prems may occupy servants' quarters or house;
- (2) That the sd prop shall be used for residence purposes only and not for any purpose of business or trade;
- (3) That no bldg exc a single dwelling house with nec outbldgs shall be erected or maintained on each of ^{sd lots} such dwelling house to cost in its construction not less than \$5000 ; it is intended hereby to prohibit, nor shall there be maintained, kept or suffered any dairy, sanitarium, apartment house, double or duplex house, inn, boarding house or place of any sort for the serving of food or refreshments to the public, public garage, public stables, public hall or transportation equipment for doing work under contract or hire; no dog kennels shall be maintained or pet stock raised for commercial purposes on any part of sd prop.
- (4) That no temporary bldgs, servants' houses, stables, garages, or other bldgs shall be used for residence purposes prior to the completion of a dwelling house on sd prop in accordance with these restrictions.

Mln
Brk
#3

(5) That no dwelling shall be erected on sd prop, the front line of which (which means the front line of any porch, or terrace, or any projection, not counting steps) shall be nearer the road or street on which sd prop faces than 40 ft; and that no dwelling shall be erected on sd prop the side line of which (which means the side line of porch or projection, not counting steps) shall be nearer the side line of sd prop than 10 ft;

(6) No outbldgs, garages, or servants' houses on sd prop shall be erected exc attached to the dwelling or if detached on the rear of sd estate clear of any easements.

6-A. The ground floor area of the main structure, exclusive of 1-story open porches and garages shall be not less than 1200 sq ft, in the case of a 1-story structure nor less than 900 sq ft in the case of a 1½, 2, or 2½-story structure.

(7) Fences, hedges and walls exceeding 3 ft in height shall not be built unless the location, design and plan shall have been submitted to and approved in writing by grantor or its agent.

(8) That no bldg shall be erected or begun on sd prop without plans, specifications and location thereof first having been submitted to and approved, in writing, by the grantor or its authorized agents;

(9) No estate may be subdivided or reduced in size by voluntary alienation, judicial sale or other proceedings, exc at the discretion and with the approval of the grantor or its authorized agents;

(10) No estate shall be cultivated for crops of any sort, exc in kitchen gardens of reasonable sizes, suitably located;

(11) There shall be no tanks or cisterns of any kind on the property, and no tanks or cisterns of any kind shall be used for any purpose. No tank or cistern shall be used for any purpose. No tank or cistern shall be used for any purpose. No sewer or drainage line shall be laid on sd lot, which shall

213

empty on, or become a nuisance to the adjoining prop.
(12) The grantor reserves the right to make any road or other improvements abutting on sd prop, and to change the present road or street grades, if nec, without liability to the pur or assigns for any claim for damages; and further reserves the rt to change or modify the restriction No 5 but no other in respect to minor variations from the requirements therein regarding distance of the dwelling from the front & side lines of the property. It is understood and agreed that as a part of the cons for this conveyance, the grantee herein agrees to conform to the foregoing conditions, limitations and restrictions and that sd conditions, limitations and restrictions shall attach to and run with the land and that it shall be lawful for the sd grantor, its succs or assigns, to institute and prosecute any proceedings at law or in equity against the person, persons, corp or corporations violating or threatening to violate the sd conditions, limitations and restrictions, and the sd conditions, limitations and restrictions may be proceeded upon against the sd grantee, heirs or assigns, for a specific execution thereof and that any failure on the part of the grantor, its succs or assigns to assert any right as herein provided shall not be deemed a waiver thereof, but it may at any time assert the same.

Warranted exc as hereinabove noted. and taxes for 1944.

No Wit.

CORP ACK: By Robt Jemison Jr as Pres 17 May 1944
before C S Davis NP JCA (Seal)

(I.R. \$2.75)

APPENDIX A
TRAFFIC STUDY

Traffic Study

Redevelopment of 2305 Montevallo Road Mountain Brook, Alabama

Prepared for:

Ingram Farris, LLC

SKIPPER
CONSULTING INC

June, 2022

Redevelopment of 2305 Montevallo Road

Mountain Brook, Alabama

Prepared for:

Ingram Farris, LLC

1900 28th Avenue South, Suite 105

Homewood, Alabama 35209

Prepared by:

Skipper Consulting, Inc.

3644 Vann Road, Suite 100

Birmingham, Alabama 35235

Phone (205) 655-8855

Fax (205) 655-8825



SIGNED: *Richard Lyn Caudle*

DATE: 6/10/22

TABLE OF CONTENTS

	Page
Introduction	1
Existing Intersection Turning Movement Traffic Counts	1
Existing Machine Traffic Counts.....	1
Existing Intersection Capacity Analysis	4
Historical Traffic Growth	5
Background 2025 Traffic Volumes	6
Planned Roadway Improvement Project	6
Background 2025 Intersection Capacity Analysis	8
Trip Generation	9
Directional Distribution.....	9
Future 2025 Traffic Volumes.....	9
Future 2025 Intersection Capacity Analysis.....	9
Recommendations	9

APPENDICES

Appendix A	Proposed Site Plan
Appendix B	Existing Intersection Turning Movement Traffic Counts
Appendix C	Machine Traffic Counts
Appendix D	Existing Intersection Capacity Analysis Worksheets
Appendix E	Background 2025 Intersection Capacity Analysis Worksheets
Appendix F	Future 2025 Intersection Capacity Analysis Worksheets

LIST OF ILLUSTRATIONS

Figure		Page
1	Site Location Map.....	2
2	Existing Traffic Counts	3
3	Background 2025 Traffic Volumes	7
4	Directional Distribution	10
5	Future 2025 Traffic Volumes	11
Table		
1	Existing Machine Traffic Counts	4
2	Existing Intersection Capacity Analysis	5
3	Historical Traffic Growth	6
4	Background 2025 Intersection Capacity Analysis.....	8
5	Trip Generation	9
6	Future 2025 Intersection Capacity Analysis	12

Introduction

This report documents a traffic impact study performed for the proposed redevelopment of 2305 Montevallo Road in the City of Mountain Brook, Alabama. Currently, the site is occupied by Shades Valley Presbyterian Church. The location of the site with respect to the area roadway network is shown in Figure 1. The proposed redevelopment plan would replace the existing land use with:

- 32 condominium units
- 14 single family detached dwelling units

Currently, the site is accessed via three driveways on Montevallo Road and a restricted driveway at the cul-de-sac end of Chester Road. Proposed access to the site is via two driveways accessing Montevallo Road (one for the single family portion of the development and one for the condominium portion of the development) and an access to Chester Road (only for the single family portion of the development).

The proposed site plan is included in Appendix A.

Development buildout and full occupation of the site is projected to occur in 2025.

Study intersections addressed in this report are shown in Figure 1 and include:

- Hollywood Boulevard at the US-280 Entrance Ramp
- Montevallo Road at the US-280 Exit Ramp
- Montevallo Road at Brookhill Condominiums
- Montevallo Road at Cahaba Road
- Cahaba Road at Chester Road

Existing Intersection Turning Movement Traffic Counts

Existing intersection turning movement traffic counts were performed at the study intersections from 7:00 to 9:00 a.m. and 4:00 to 6:00 p.m. on Wednesday to Thursday, March 23 to 24, 2022 by Traffic Data, LLC on behalf of Skipper Consulting, Inc. The intersection turning movement traffic count data is included in Appendix B. The a.m. and p.m. peak hours of traffic flow at the study intersections were calculated. The a.m. and p.m. peak hour intersection turning movement traffic counts are shown in Figure 2.

Existing Machine Traffic Counts

Existing 24 hour machine traffic counts were performed on Montevallo Road east of U.S. Highway 280 and Cahaba Road south of Montevallo Road on Wednesday to Thursday, March 23 to 24, 2022 by Traffic Data, LLC on behalf of Skipper Consulting, Inc. the machine traffic count data is included in Appendix C. The machine traffic count data is summarized in Table 1.

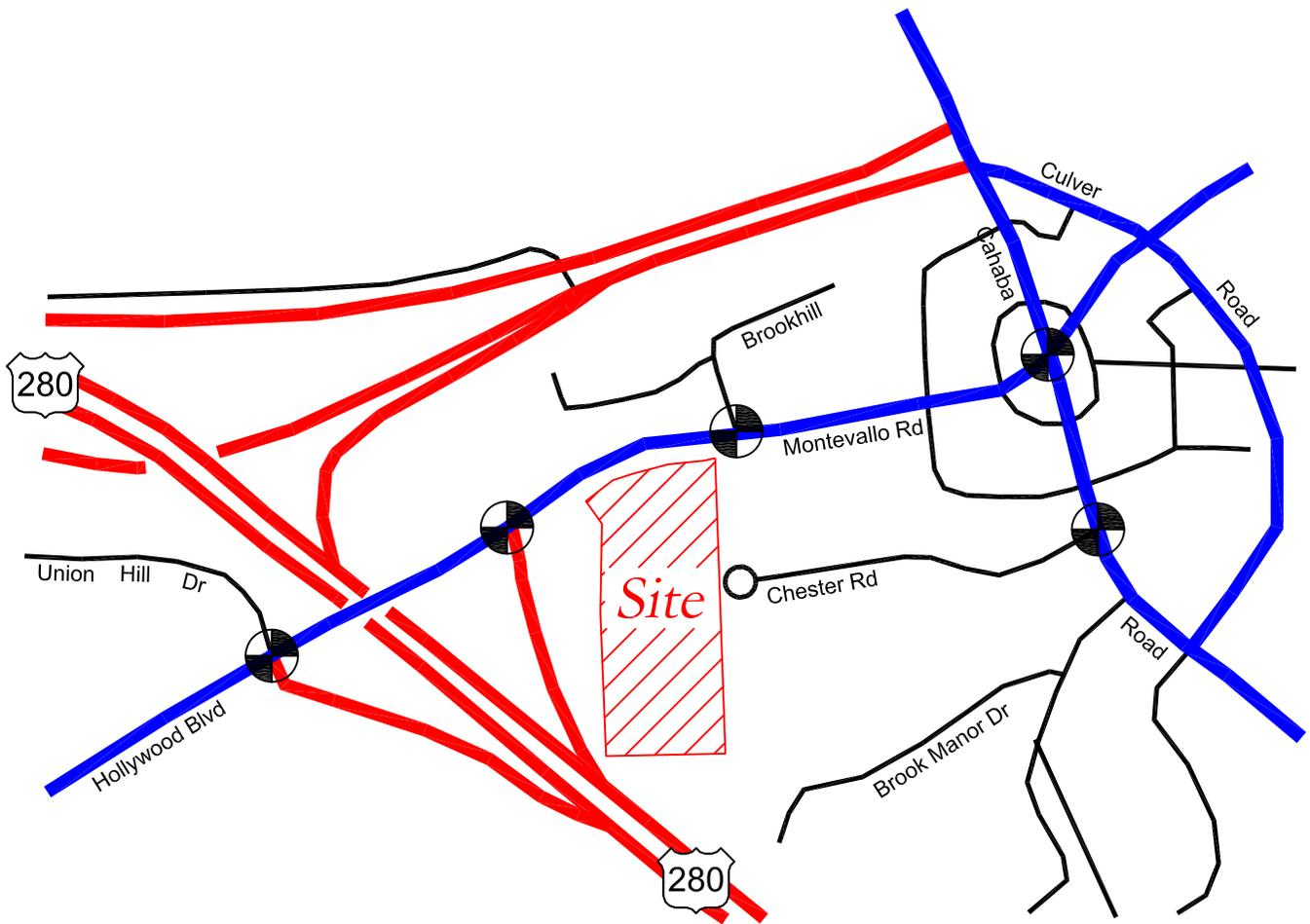

Legend

 Study Intersection



North
Scale: n.t.s

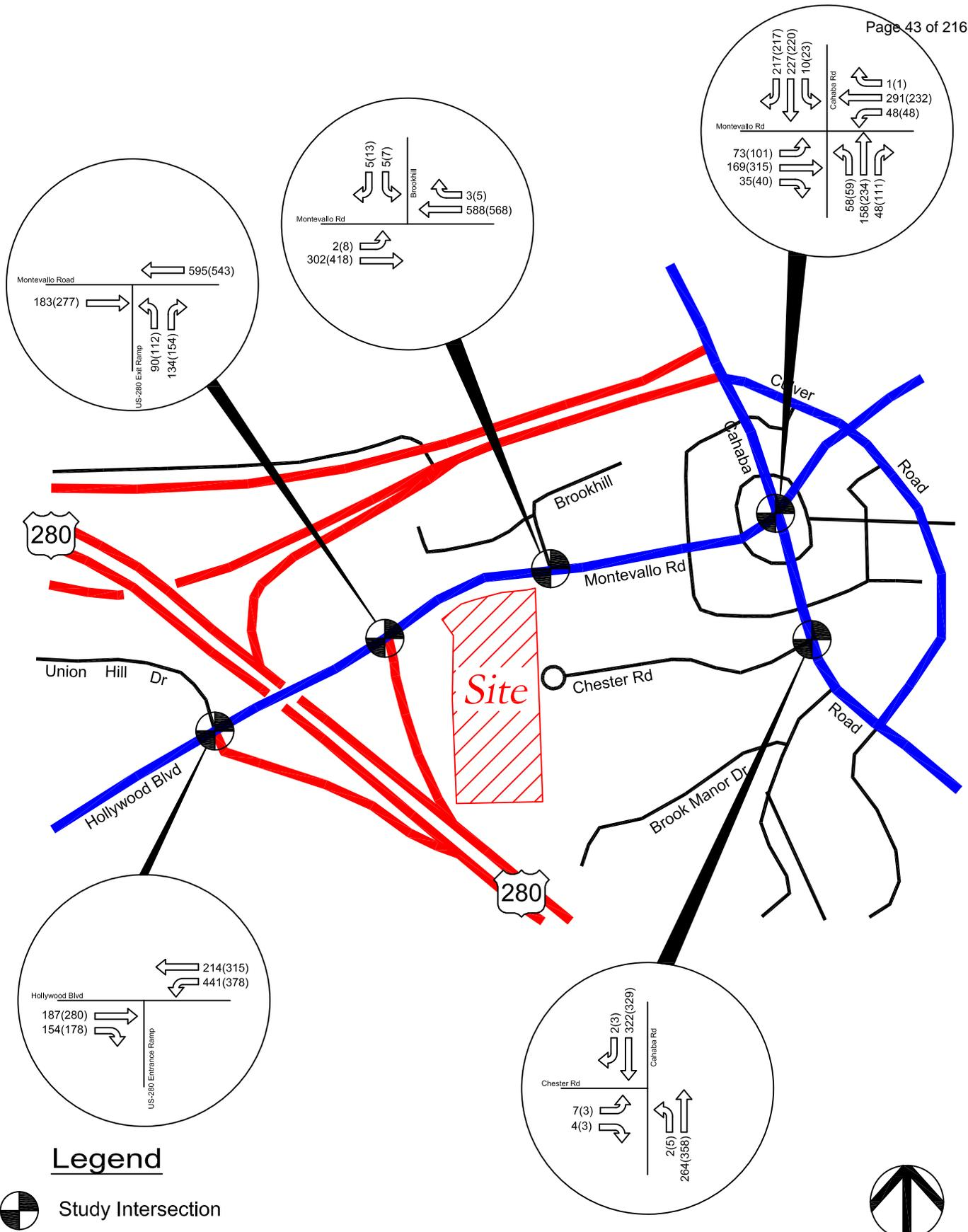

Table 1
Existing Machine Traffic Counts

<i>Time</i>	<i>Montevallo Road east of US-280</i>			<i>Cahaba Road south of Montevallo Road</i>		
	<i>Eastbound</i>	<i>Westbound</i>	<i>Total</i>	<i>Northbound</i>	<i>Southbound</i>	<i>Total</i>
12-1 AM	4	8	12	2	3	5
1-2 AM	1	6	7	2	0	2
2-3 AM	0	7	7	0	0	0
3-4 AM	1	6	7	2	5	7
4-5 AM	13	10	23	9	10	19
5-6 AM	53	61	114	17	21	38
6-7 AM	111	185	296	62	72	134
7-8 AM	277	518	795	215	261	476
8-9 AM	323	500	823	207	329	536
9-10 AM	343	477	820	263	296	559
10-11 AM	379	487	866	277	270	547
11-12 PM	410	578	988	398	328	726
12-1 PM	399	611	1010	420	347	767
1-2 PM	415	674	1089	364	352	716
2-3 PM	393	630	1023	385	325	710
3-4 PM	378	634	1012	406	281	687
4-5 PM	413	545	958	405	291	696
5-6 PM	413	521	934	391	322	713
6-7 PM	288	419	707	285	178	463
7-8 PM	184	278	462	203	139	342
8-9 PM	164	242	406	107	102	209
9-10 PM	68	152	220	72	58	130
10-11 PM	27	58	85	38	24	62
11-12 AM	6	25	31	4	8	12
Total	5063	7632	12695	4534	4022	8556

Existing Intersection Capacity Analysis

Existing a.m. and p.m. peak hour intersection capacity analyses were performed for the study intersections using the method of analysis included in the *Highway Capacity Manual*, published by the Transportation Research Board. Capacities are expressed as levels of service, and range from a level of service "A" (highest quality of service) to a level of service "F" (jammed conditions). As a general rule, operation at a level of service "C" or better is desirable, with a level of service "D" considered acceptable during peak hours of traffic flow. The results of the existing a.m. and p.m. peak hour intersection capacity analyses are included in Appendix D and are summarized in Table 2.

Table 2
Existing Intersection Capacity Analysis

<i>Intersection</i>	<i>Approach</i>	<i>Movement</i>	<i>Level of Service</i>	
			<i>AM Peak</i>	<i>PM Peak</i>
Montevallo Road at US-280 Entrance Ramp	Montevallo Road Westbound	Left-Through	A	A
Montevallo Road at US-280 Exit Ramp	US-280 Exit Ramp Northbound	Left	C	C
		Right	B	B
		<i>Overall approach</i>	<i>B</i>	<i>C</i>
Montevallo Road at Brookhill Condos	Montevallo Road Eastbound	Left	A	A
	Brookhill Southbound	Left-Right	C	C
Montevallo Road at Cahaba Road	Montevallo Road Eastbound	Left	B	B
		Through-Right	B	B
		<i>Overall approach</i>	<i>B</i>	<i>B</i>
	Montevallo Road Westbound	Left	A	B
		Through-Right	B	B
		<i>Overall approach</i>	<i>B</i>	<i>B</i>
	Cahaba Road Northbound	Left	A	A
		Through-Right	A	A
		<i>Overall approach</i>	<i>A</i>	<i>A</i>
	Cahaba Road Southbound	Left	A	A
		Through-Right	B	B
		<i>Overall approach</i>	<i>B</i>	<i>B</i>
<i>Overall intersection</i>			<i>B</i>	<i>B</i>
Cahaba Road at Chester Road	Cahaba Road Northbound	Left	A	A
	Chester Road Eastbound	Left-Right	B	B

Historical Traffic Growth

Historical traffic counts for the years 2014 to 2020 were obtained for Montevallo Road, Hollywood Boulevard, and Cahaba Road in the vicinity of the site from the Alabama Department of Transportation website. Traffic counts from the year 2020 were rejected because they appear to be significantly lower than 2019 traffic counts, probably due to Covid-19 impacts. An analysis was performed to determine the rate of traffic growth on the area roadways using the traffic count data from 2014 to 2019. The historical traffic counts and growth analysis is shown in Table 3. Montevallo Road has shown an increase in traffic, while Hollywood Boulevard and Cahaba Road have both shown decreases in traffic. Combining the results from all three count stations, and overall growth rate of 0.5% per year was calculated and was used for analysis in the remainder of this report.

Table 3
Historical Traffic Growth

Year	Montevallo Road		Hollywood Boulevard		Cahaba Road	
	Count	Growth	Count	Growth	Count	Growth
2014	11050		9040		8370	
2015	12040	9.0%	8160	-9.7%	8120	-3.0%
2016	12330	2.4%	8360	2.5%	8320	2.5%
2017	12390	0.5%	8420	0.7%	8270	-0.6%
2018	12855	3.8%	8736	3.8%	7897	-4.5%
2019	12840	-0.1%	8726	-0.1%	7888	-0.1%
average		3.1%		-0.6%		-1.1%
overall		3.2%		-0.7%		-1.2%

Background 2025 Traffic Volumes

Existing intersection turning movement traffic counts were projected forward to the year 2025 using the +0.5% per year traffic growth rate. The resultant Background 2025 traffic volumes are shown in Figure 3.

Planned Roadway Improvement Project

In 2018, the cities of Homewood and Mountain Brook began efforts to modify the existing Hollywood Boulevard bridge over U.S. Highway 280 to add a pedestrian walkway. With additional funding from Jefferson County and the State of Alabama as well as private donors, the project is currently moving forward in the design process under the direction of Jefferson County Roads and Transportation. AECOM was hired in September, 2021 to prepare construction plans. The most current concept includes not only construction of a pedestrian walkway, but also widens the bridge to three travel lanes and installs a traffic signal at the east end of the bridge for traffic exiting the U.S. Highway 280 ramp. The conceptual plan is shown below. Expected bid letting is in August, 2022.



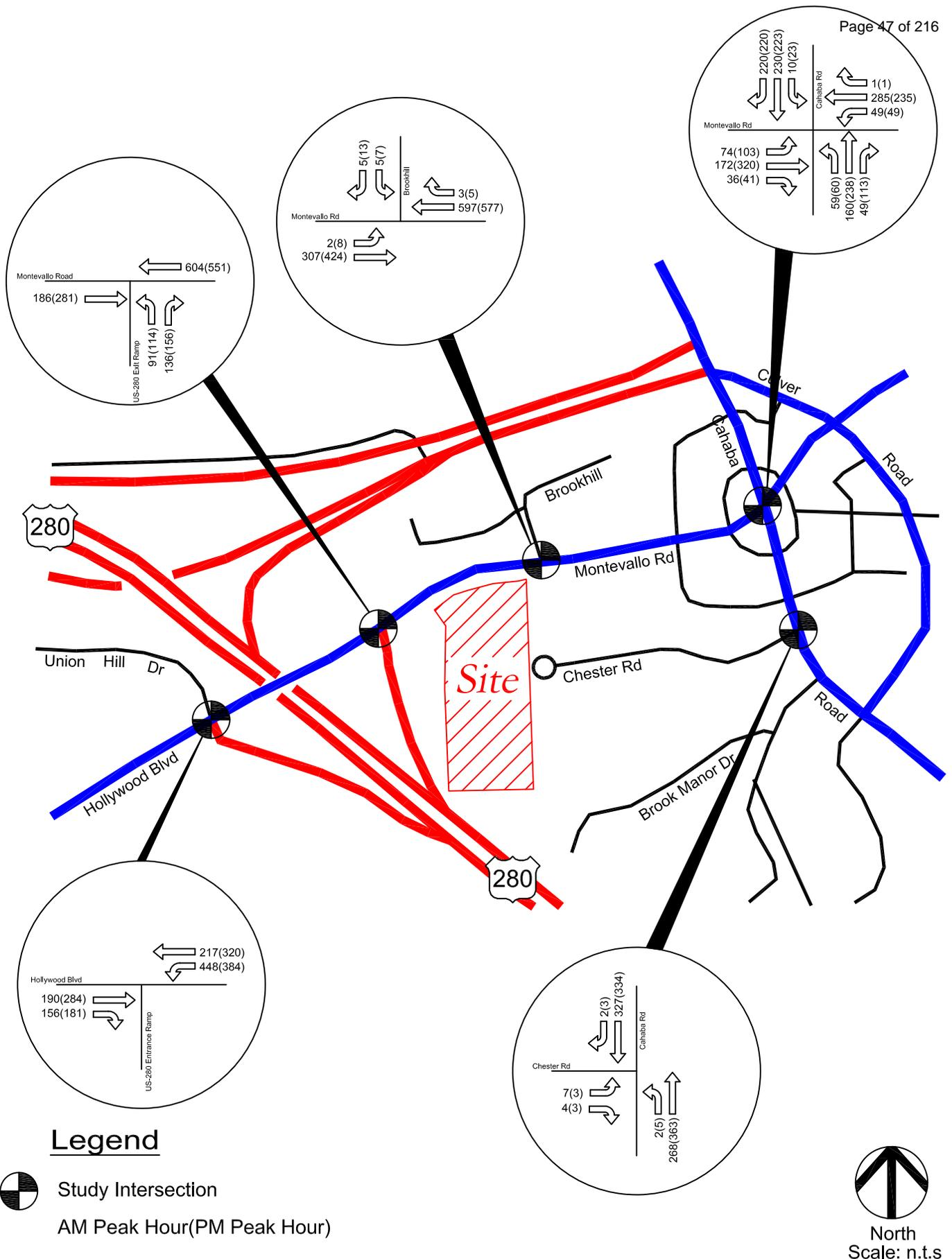

Background 2025 Intersection Capacity Analysis

Background 2025 a.m. and p.m. peak hour intersection capacity analyses were performed for the study intersections using the method of analysis included in the *Highway Capacity Manual*. The analyses include the proposed improvements documented in the previous section of this report. The results of the Background 2025 a.m. and p.m. peak hour intersection capacity analyses are included in Appendix E and are summarized in Table 4.

Table 4
Background 2025 Intersection Capacity Analysis

<i>Intersection</i>	<i>Approach</i>	<i>Movement</i>	<i>Level of Service</i>	
			<i>AM Peak</i>	<i>PM Peak</i>
Montevallo Road at US-280 Entrance Ramp	Montevallo Road Westbound	Left	A	A
Montevallo Road at US-280 Exit Ramp	Montevallo Road Eastbound	Through	A	A
	Montevallo Road Westbound	Through	A	A
	US-280 Exit Ramp Northbound	Left	B	B
		Right	B	B
		<i>Overall approach</i>	<i>B</i>	<i>B</i>
		Overall Intersection	A	A
Montevallo Road at Brookhill Condos	Montevallo Road Eastbound	Left	A	A
	Brookhill Southbound	Left-Right	C	C
Montevallo Road at Cahaba Road	Montevallo Road Eastbound	Left	B	B
		Through-Right	B	B
		<i>Overall approach</i>	<i>B</i>	<i>B</i>
	Montevallo Road Westbound	Left	A	B
		Through-Right	B	B
		<i>Overall approach</i>	<i>B</i>	<i>B</i>
	Cahaba Road Northbound	Left	A	A
		Through-Right	A	A
		<i>Overall approach</i>	<i>A</i>	<i>A</i>
	Cahaba Road Southbound	Left	A	A
		Through-Right	B	B
		<i>Overall approach</i>	<i>B</i>	<i>B</i>
		Overall intersection	B	B
Cahaba Road at Chester Road	Cahaba Road Northbound	Left	A	A
	Chester Road Eastbound	Left-Right	B	B

Trip Generation

The trip generation potential for the proposed development was estimated based on information contained in the Institute of Transportation Engineers publication *Trip Generation, 11th Edition*. The trip generation estimate for the proposed development is shown in Table 5.

**Table 5
Trip Generation**

Land Use	Size		ITE Code	Daily			AM Peak Hour			PM Peak Hour		
				In	Out	Total	In	Out	Total	In	Out	Total
Condominium	32	d.u.'s	220	108	108	216	3	10	13	10	6	16
Single Family	14	d.u.'s	210	83	83	166	3	9	12	10	6	16
Total				191	191	382	6	19	25	20	12	32

Directional Distribution

The directions of approach of traffic generated by the development was estimated based on existing patterns of traffic flow on the area roadways. The directional distribution is shown in Figure 4.

Future 2025 Traffic Volumes

Traffic projected to be generated by the proposed development during the a.m. and p.m. peak hours was assigned to the study intersections and site access points based on the directional distribution and access usage assumptions and was then added to Background 2025 traffic volumes. The resultant Future 2025 a.m. and p.m. peak hour traffic volume projections are shown in Figure 5.

Future 2025 Intersection Capacity Analysis

Future 2025 a.m. and p.m. peak hour intersection capacity analyses were performed for the study intersections using the method of analysis included in the *Highway Capacity Manual*. The results of the Future 2025 a.m. and p.m. peak hour intersection capacity analyses are included in Appendix F and are summarized in Table 6.

Recommendations

The findings of this report are that no roadway improvements are required to mitigate the traffic impacts of the proposed development. Levels of service remain unchanged from Background 2025 conditions to Future 2025 conditions with development traffic added. The proposed site access driveways can be constructed with two lane cross sections. No turn lanes are required at the site access points to provide adequate traffic operations.

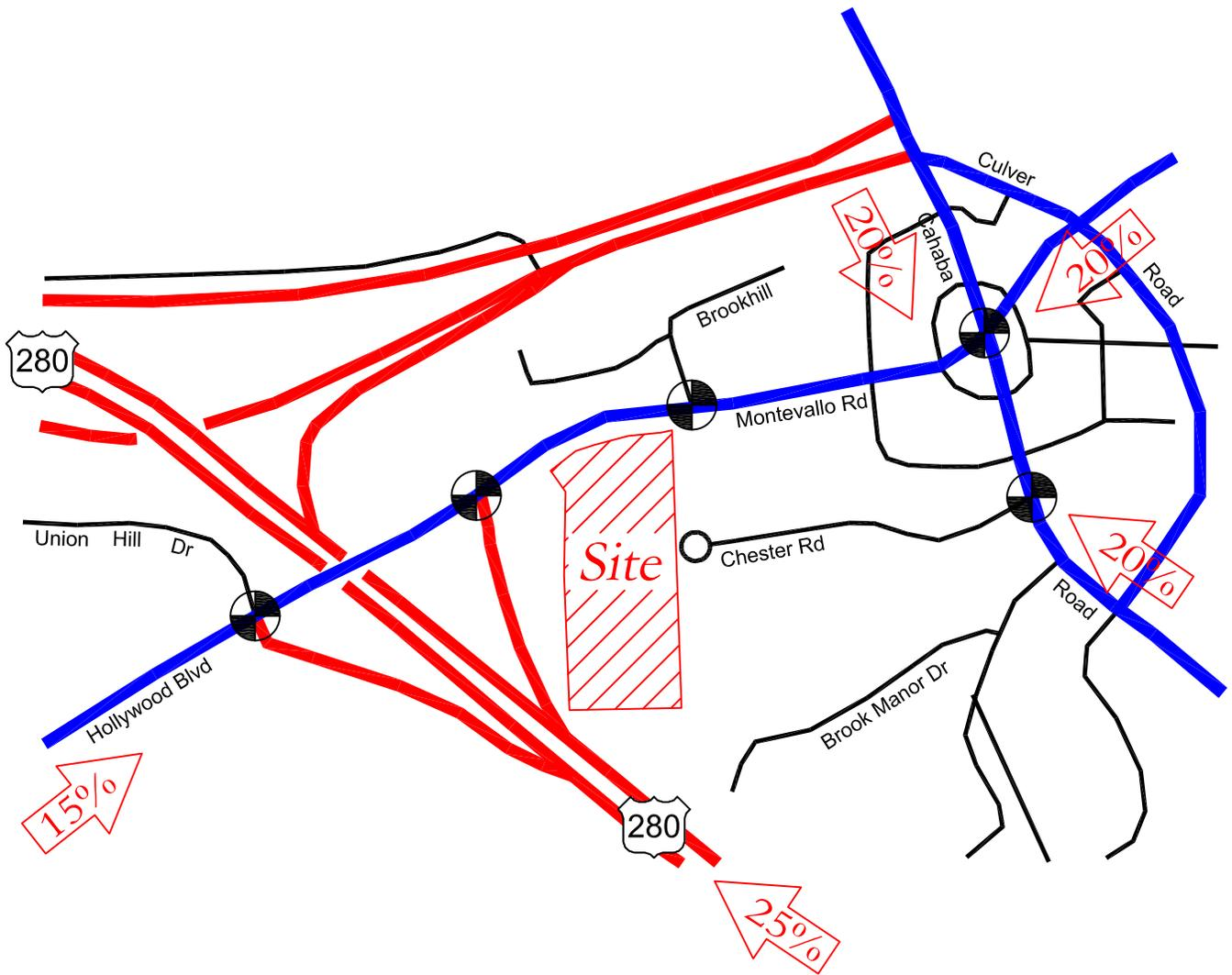

Legend

 Study Intersection

North
Scale: n.t.s

SKIPPER Figure 4 - Directional Distribution

CONSULTING INC 2305 Montevallo Road Redevelopment

June 2022



North
Scale: n.t.s

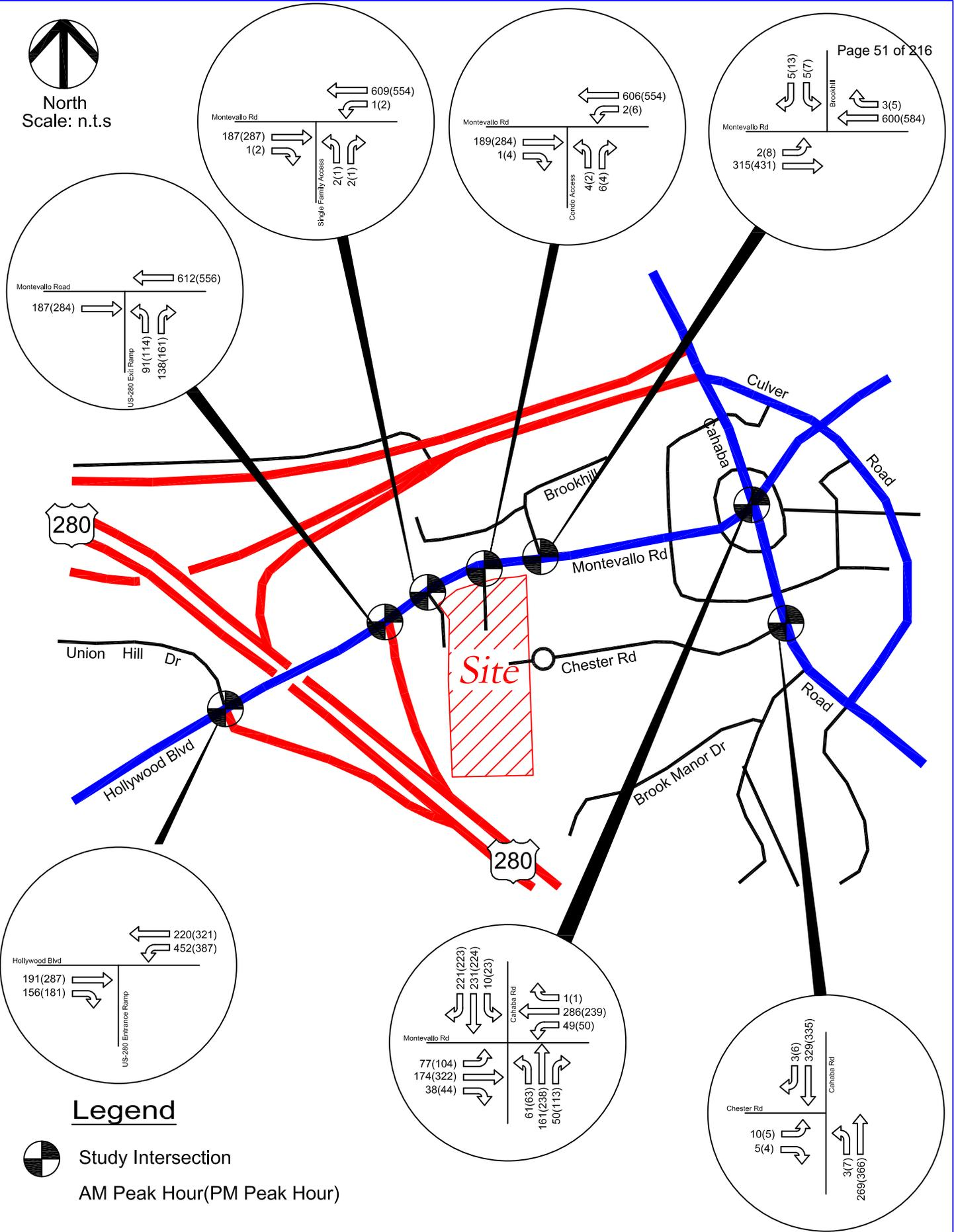

SKIPPER Figure 5 - Future 2025 Traffic Volumes

Table 6
Future 2025 Intersection Capacity Analysis

<i>Intersection</i>	<i>Approach</i>	<i>Movement</i>	<i>Level of Service</i>	
			<i>AM Peak</i>	<i>PM Peak</i>
Montevallo Road at US-280 Entrance Ramp	Montevallo Road Westbound	Left	A	A
Montevallo Road at US-280 Exit Ramp	Montevallo Road Eastbound	Through	A	A
	Montevallo Road Westbound	Through	A	A
	US-280 Exit Ramp Northbound	Left	B	B
		Right	B	B
	<i>Overall approach</i>		<i>B</i>	<i>B</i>
<i>Overall Intersection</i>		<i>A</i>	<i>A</i>	
Montevallo Road at Brookhill Condos	Montevallo Road Eastbound	Left	A	A
	Brookhill Southbound	Left-Right	C	C
Montevallo Road at Cahaba Road	Montevallo Road Eastbound	Left	B	B
		Through-Right	B	B
		<i>Overall approach</i>	<i>B</i>	<i>B</i>
	Montevallo Road Westbound	Left	A	B
		Through-Right	B	B
		<i>Overall approach</i>	<i>B</i>	<i>B</i>
	Cahaba Road Northbound	Left	A	A
		Through-Right	A	B
		<i>Overall approach</i>	<i>A</i>	<i>A</i>
	Cahaba Road Southbound	Left	A	A
		Through-Right	B	B
		<i>Overall approach</i>	<i>B</i>	<i>B</i>
<i>Overall intersection</i>		<i>B</i>	<i>B</i>	
Cahaba Road at Chester Road	Cahaba Road Northbound	Left	A	A
	Chester Road Eastbound	Left-Right	B	B
Montevallo Road at Single Family Access	Montevallo Road Westbound	Left-Through	A	A
	Site Access Northbound	Left-Right	B	B
Montevallo Road at Condo Access	Montevallo Road Westbound	Left-Through	A	A
	Site Access Northbound	Left-Right	B	B

Appendix A

Proposed Site Plan

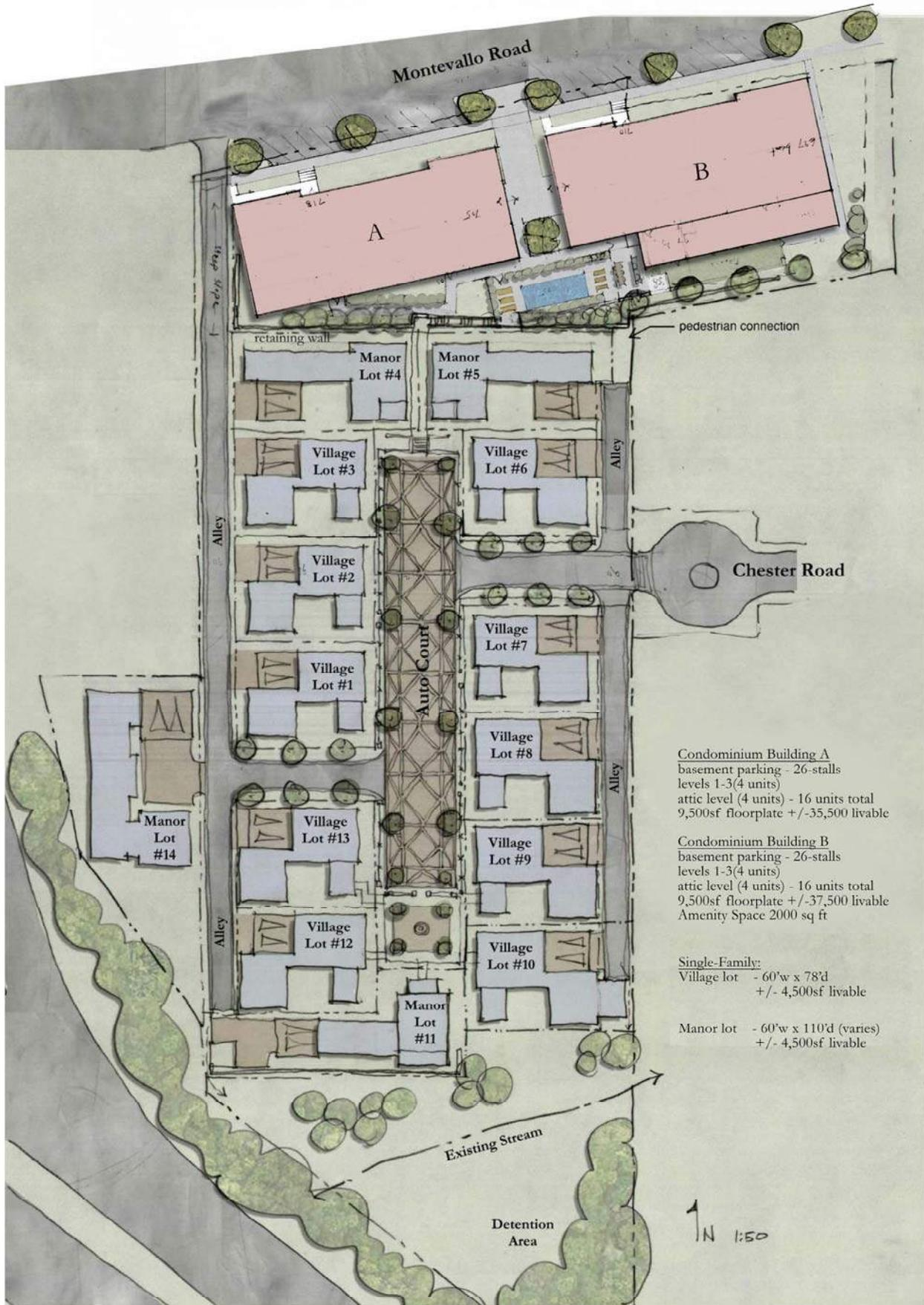

Condominium Building A
 basement parking - 26-stalls
 levels 1-3(4 units) - 16 units total
 attic level (4 units) - 16 units total
 9,500sf floorplate +/-35,500 livable

Condominium Building B
 basement parking - 26-stalls
 levels 1-3(4 units) - 16 units total
 attic level (4 units) - 16 units total
 9,500sf floorplate +/-37,500 livable
 Amenity Space 2000 sq ft

Single-Family:
 Village lot - 60'w x 78'd
 +/- 4,500sf livable

Manor lot - 60'w x 110'd (varies)
 +/- 4,500sf livable

Appendix B

Existing Intersection Turning Movement Traffic Counts

TRAFFIC DATA, LLC

PO Box 187

Cullman, AL 35056

205-824-0125

Mountain Brook, AL

File Name : mountainbrook04

Site Code : 00000000

Start Date : 03/23/2022

Page No : 1

Groups Printed- Unshifted

Start Time	HOLLYWOOD BLVD Westbound		US 280 ON RAMP Northbound	HOLLYWOOD BLVD Eastbound		Int. Total
	Left	Thru	Thru	Thru	Right	
04:00 PM	109	55	0	58	51	273
04:15 PM	113	76	0	76	44	309
04:30 PM	81	71	0	56	45	253
04:45 PM	96	87	0	77	43	303
Total	399	289	0	267	183	1138
05:00 PM	88	81	0	71	46	286
05:15 PM	75	80	0	73	30	258
05:30 PM	85	92	0	67	39	283
05:45 PM	67	65	0	47	29	208
Total	315	318	0	258	144	1035
07:00 AM	65	32	0	39	24	160
07:15 AM	82	47	0	38	21	188
07:30 AM	102	49	0	38	44	233
07:45 AM	128	49	0	53	24	254
Total	377	177	0	168	113	835
08:00 AM	96	51	0	54	50	251
08:15 AM	115	65	0	42	36	258
08:30 AM	71	43	0	41	31	186
08:45 AM	110	62	0	58	34	264
Total	392	221	0	195	151	959
Grand Total	1483	1005	0	888	591	3967
Apprch %	59.6	40.4	0.0	60.0	40.0	
Total %	37.4	25.3	0.0	22.4	14.9	

Start Time	App. Total	HOLLYWOOD BLVD Westbound			US 280 ON RAMP Northbound		HOLLYWOOD BLVD Eastbound			Int. Total
		Left	Thru	App. Total	Thru	App. Total	Thru	Right	App. Total	
Peak Hour From 04:00 PM to 05:45 PM - Peak 1 of 1										
Intersection	04:15 PM									
Volume	0	378	315	693	0	0	280	178	458	1151
Percent		54.5	45.5		0.0		61.1	38.9		
04:15 Volume	0	113	76	189	0	0	76	44	120	309
Peak Factor										0.931
High Int.	3:45:00 PM	04:15 PM			3:45:00 PM		04:15 PM			
Volume	0	113	76	189	0	0	76	44	120	
Peak Factor				0.917					0.954	
Peak Hour From 04:00 PM to 05:45 PM - Peak 1 of 1										
By Approach	04:00 PM	04:15 PM			04:00 PM		04:15 PM			
Volume	0	378	315	693	0	0	280	178	458	
Percent		54.5	45.5		-		61.1	38.9		
High Int.	-	04:15 PM			-		04:15 PM			
Volume	-	113	76	189	-	-	76	44	120	
Peak Factor	-			0.917	-	-			0.954	

TRAFFIC DATA, LLC

PO Box 187
 Cullman, AL 35056
 205-824-0125

File Name : mountainbrook04
 Site Code : 00000000
 Start Date : 03/23/2022
 Page No : 2

Start Time	App. Total	HOLLYWOOD BLVD Westbound			US 280 ON RAMP Northbound		HOLLYWOOD BLVD Eastbound			Int. Total
		Left	Thru	App. Total	Thru	App. Total	Thru	Right	App. Total	
Peak Hour From 07:00 AM to 08:45 AM - Peak 1 of 1										
Intersection	07:30 AM									
Volume	0	441	214	655	0	0	187	154	341	996
Percent		67.3	32.7		0.0		54.8	45.2		
08:15 Volume	0	115	65	180	0	0	42	36	78	258
Peak Factor										0.965
High Int.		08:15 AM					08:00 AM			
Volume	0	115	65	180	0	0	54	50	104	
Peak Factor				0.910					0.820	
Peak Hour From 07:00 AM to 08:45 AM - Peak 1 of 1										
By Approach	07:00 AM	07:30 AM			07:00 AM		08:00 AM			
Volume	0	441	214	655	0	0	195	151	346	
Percent		67.3	32.7		-		56.4	43.6		
High Int.	-	08:15 AM			-		08:00 AM			
Volume	-	115	65	180	-	-	54	50	104	
Peak Factor	-			0.910	-	-			0.832	

TRAFFIC DATA, LLC

PO Box 187

Cullman, AL 35056

205-824-0125

Mountain Brook, AL

File Name : mountainbrook03

Site Code : 00000000

Start Date : 03/23/2022

Page No : 1

Groups Printed- Unshifted

Start Time	BROOKHILL Southbound		MONTEVALLO RD Westbound		MONTEVALLO RD Eastbound		Int. Total
	Left	Right	Thru	Right	Left	Thru	
04:00 PM	2	1	140	5	0	85	233
04:15 PM	2	2	158	3	2	102	269
04:30 PM	3	0	133	0	2	84	222
04:45 PM	0	5	128	1	3	119	256
Total	7	8	559	9	7	390	980
05:00 PM	2	6	149	1	1	113	272
05:15 PM	4	0	117	2	2	105	230
05:30 PM	1	0	148	0	0	98	247
05:45 PM	1	0	110	3	0	86	200
Total	8	6	524	6	3	402	949
07:00 AM	2	2	90	0	1	51	146
07:15 AM	0	2	115	1	0	64	182
07:30 AM	0	1	147	0	0	73	221
07:45 AM	3	2	169	3	0	84	261
Total	5	7	521	4	1	272	810
08:00 AM	1	2	130	0	1	79	213
08:15 AM	1	0	142	0	1	66	210
08:30 AM	3	0	96	1	1	71	172
08:45 AM	1	1	133	1	2	100	238
Total	6	3	501	2	5	316	833
Grand Total	26	24	2105	21	16	1380	3572
Apprch %	52.0	48.0	99.0	1.0	1.1	98.9	
Total %	0.7	0.7	58.9	0.6	0.4	38.6	

Start Time	BROOKHILL Southbound			MONTEVALLO RD Westbound			App. Total	MONTEVALLO RD Eastbound			Int. Total
	Left	Right	App. Total	Thru	Right	App. Total		Left	Thru	App. Total	
Peak Hour From 04:00 PM to 05:45 PM - Peak 1 of 1											
Intersection	04:15 PM										
Volume	7	13	20	568	5	573	0	8	418	426	1019
Percent	35.0	65.0		99.1	0.9			1.9	98.1		
05:00 Volume	2	6	8	149	1	150	0	1	113	114	272
Peak Factor											0.937
High Int.	05:00 PM			04:15 PM			3:45:00 PM	04:45 PM			
Volume	2	6	8	158	3	161	0	3	119	122	
Peak Factor			0.625			0.890				0.873	
Peak Hour From 04:00 PM to 05:45 PM - Peak 1 of 1											
By Approach	04:15 PM			04:15 PM			04:00 PM	04:45 PM			
Volume	7	13	20	568	5	573	0	6	435	441	
Percent	35.0	65.0		99.1	0.9			1.4	98.6		
High Int.	05:00 PM			04:15 PM			-	04:45 PM			
Volume	2	6	8	158	3	161	-	3	119	122	
Peak Factor			0.625			0.890	-			0.904	

TRAFFIC DATA, LLC

PO Box 187
 Cullman, AL 35056
 205-824-0125

File Name : mountainbrook03
 Site Code : 00000000
 Start Date : 03/23/2022
 Page No : 2

Start Time	BROOKHILL Southbound			MONTEVALLO RD Westbound			App. Total	MONTEVALLO RD Eastbound			Int. Total	
	Left	Right	App. Total	Thru	Right	App. Total		Left	Thru	App. Total		
Peak Hour From 07:00 AM to 08:45 AM - Peak 1 of 1												
Intersection	07:30 AM											
Volume	5	5	10	588	3	591	0	2	302	304	905	
Percent	50.0	50.0		99.5	0.5			0.7	99.3			
07:45 Volume	3	2	5	169	3	172	0	0	84	84	261	
Peak Factor											0.867	
High Int.	07:45 AM			07:45 AM				07:45 AM				
Volume	3	2	5	169	3	172	0	0	84	84		
Peak Factor	0.500			0.859				0.905				
Peak Hour From 07:00 AM to 08:45 AM - Peak 1 of 1												
By Approach	07:00 AM			07:30 AM				07:00 AM			08:00 AM	
Volume	5	7	12	588	3	591	0	5	316	321		
Percent	41.7	58.3		99.5	0.5			1.6	98.4			
High Int.	07:45 AM			07:45 AM				08:45 AM				
Volume	3	2	5	169	3	172	-	2	100	102		
Peak Factor	0.600			0.859				-			0.787	

TRAFFIC DATA, LLC

PO Box 187

Cullman, AL 35056

205-824-0125

Mountain Brook, AL

File Name : mountainbrook02

Site Code : 00000000

Start Date : 03/23/2022

Page No : 1

Groups Printed- Unshifted

Start Time	CAHABA RD Southbound			MONTEVALLO RD Westbound			CAHABA RD Northbound			MONTEVALLO RD Eastbound			Int. Total
	Left	Thru	Right	Left	Thru	Right	Left	Thru	Right	Left	Thru	Right	
04:00 PM	4	47	57	4	58	1	19	53	38	26	55	12	374
04:15 PM	8	38	55	7	75	0	17	53	23	26	61	10	373
04:30 PM	10	57	49	16	49	1	14	53	27	23	59	6	364
04:45 PM	6	58	42	15	65	1	19	65	17	20	90	12	410
Total	28	200	203	42	247	3	69	224	105	95	265	40	1521
05:00 PM	4	41	53	14	53	0	18	66	28	26	79	11	393
05:15 PM	11	60	59	7	45	0	10	60	34	31	70	7	394
05:30 PM	2	61	63	12	69	0	12	43	32	24	76	10	404
05:45 PM	4	54	33	5	59	0	10	46	31	19	60	7	328
Total	21	216	208	38	226	0	50	215	125	100	285	35	1519
07:00 AM	1	16	27	7	45	0	6	17	7	6	33	3	168
07:15 AM	1	40	27	8	71	0	10	27	5	16	30	6	241
07:30 AM	3	60	58	8	74	0	12	48	15	15	42	7	342
07:45 AM	3	46	61	15	84	0	14	43	15	18	50	15	364
Total	8	162	173	38	274	0	42	135	42	55	155	31	1115
08:00 AM	3	61	45	13	65	0	15	33	8	23	45	7	318
08:15 AM	1	60	53	12	68	1	17	34	10	17	32	6	311
08:30 AM	0	42	27	15	52	0	9	35	11	17	43	5	256
08:45 AM	0	47	50	14	64	1	8	31	12	28	49	10	314
Total	4	210	175	54	249	2	49	133	41	85	169	28	1199
Grand Total	61	788	759	172	996	5	210	707	313	335	874	134	5354
Apprch %	3.8	49.0	47.2	14.7	84.9	0.4	17.1	57.5	25.4	24.9	65.1	10.0	
Total %	1.1	14.7	14.2	3.2	18.6	0.1	3.9	13.2	5.8	6.3	16.3	2.5	

Start Time	CAHABA RD Southbound				MONTEVALLO RD Westbound				CAHABA RD Northbound				MONTEVALLO RD Eastbound				Int. Total
	Left	Thru	Right	App. Total	Left	Thru	Right	App. Total	Left	Thru	Right	App. Total	Left	Thru	Right	App. Total	
Peak Hour From 04:00 PM to 05:45 PM - Peak 1 of 1																	
Intersection	04:45 PM				04:45 PM				05:00 PM				04:45 PM				1601
Volume	23	220	217	460	48	232	1	281	59	234	111	404	101	315	40	456	
Percent	5.0	47.8	47.2		17.1	82.6	0.4		14.6	57.9	27.5		22.1	69.1	8.8		
04:45	04:45 PM				04:45 PM				05:00 PM				04:45 PM				410
Volume	6	58	42	106	15	65	1	81	19	65	17	101	20	90	12	122	
Peak Factor	0.885				0.867				0.902				0.934				0.976
High Int.	05:15 PM				04:45 PM				05:00 PM				04:45 PM				
Volume	11	60	59	130	15	65	1	81	18	66	28	112	20	90	12	122	
Peak Factor	0.885				0.867				0.902				0.934				
Peak Hour From 04:00 PM to 05:45 PM - Peak 1 of 1																	
By Approach	04:45 PM				04:15 PM				04:30 PM				04:45 PM				
Volume	23	220	217	460	52	242	2	296	61	244	106	411	101	315	40	456	
Percent	5.0	47.8	47.2		17.6	81.8	0.7		14.8	59.4	25.8		22.1	69.1	8.8		
High Int.	05:15 PM				04:15 PM				05:00 PM				04:45 PM				
Volume	11	60	59	130	7	75	0	82	18	66	28	112	20	90	12	122	
Peak Factor	0.885				0.902				0.917				0.934				

TRAFFIC DATA, LLC

PO Box 187
 Cullman, AL 35056
 205-824-0125

File Name : mountainbrook02
 Site Code : 00000000
 Start Date : 03/23/2022
 Page No : 2

Start Time	CAHABA RD Southbound				MONTEVALLO RD Westbound				CAHABA RD Northbound				MONTEVALLO RD Eastbound				Int. Total
	Left	Thru	Right	App. Total	Left	Thru	Right	App. Total	Left	Thru	Right	App. Total	Left	Thru	Right	App. Total	
Peak Hour From 07:00 AM to 08:45 AM - Peak 1 of 1																	
Intersection	07:30 AM																
Volume	10	227	217	454	48	291	1	340	58	158	48	264	73	169	35	277	1335
Percent	2.2	50.0	47.8		14.1	85.6	0.3		22.0	59.8	18.2		26.4	61.0	12.6		
07:45																	
Volume	3	46	61	110	15	84	0	99	14	43	15	72	18	50	15	83	364
Peak Factor																	0.917
High Int.	07:30 AM				07:45 AM				07:30 AM				07:45 AM				
Volume	3	60	58	121	15	84	0	99	12	48	15	75	18	50	15	83	
Peak Factor	0.938								0.859				0.880				0.834
Peak Hour From 07:00 AM to 08:45 AM - Peak 1 of 1																	
By Approach	07:30 AM				07:30 AM				07:30 AM				08:00 AM				
Volume	10	227	217	454	48	291	1	340	58	158	48	264	85	169	28	282	
Percent	2.2	50.0	47.8		14.1	85.6	0.3		22.0	59.8	18.2		30.1	59.9	9.9		
High Int.	07:30 AM				07:45 AM				07:30 AM				08:45 AM				
Volume	3	60	58	121	15	84	0	99	12	48	15	75	28	49	10	87	
Peak Factor	0.938								0.859				0.880				0.810

TRAFFIC DATA, LLC

PO Box 187

Cullman, AL 35056

205-824-0125

Mountain Brook, AL

File Name : mountainbrook05

Site Code : 00000000

Start Date : 03/23/2022

Page No : 1

Groups Printed- 1 - Unshifted

Start Time	CAHABA RD Southbound		CAHABA RD Northbound		CHESTER RD Eastbound		Int. Total
	Thru	Right	Left	Thru	Left	Right	
04:00 PM	64	1	0	97	4	1	167
04:15 PM	51	0	1	93	0	2	147
04:30 PM	77	0	1	80	1	2	161
04:45 PM	85	0	1	99	0	1	186
Total	277	1	3	369	5	6	661
05:00 PM	70	2	1	103	2	0	178
05:15 PM	81	1	2	89	1	1	175
05:30 PM	93	0	1	67	0	1	162
05:45 PM	75	0	0	84	1	1	161
Total	319	3	4	343	4	3	676
07:00 AM	29	0	0	23	1	0	53
07:15 AM	56	0	0	42	0	0	98
07:30 AM	80	0	1	81	0	1	163
07:45 AM	82	1	0	70	2	1	156
Total	247	1	1	216	3	2	470
08:00 AM	80	1	1	63	5	1	151
08:15 AM	80	0	0	50	0	1	131
08:30 AM	64	0	1	48	1	1	115
08:45 AM	75	0	1	51	2	0	129
Total	299	1	3	212	8	3	526
Grand Total	1142	6	11	1140	20	14	2333
Apprch %	99.5	0.5	1.0	99.0	58.8	41.2	
Total %	48.9	0.3	0.5	48.9	0.9	0.6	

Start Time	CAHABA RD Southbound			CAHABA RD Northbound			CHESTER RD Eastbound			Int. Total
	Thru	Right	App. Total	App. Total	Left	Thru	App. Total	Left	Right	
Peak Hour From 04:00 PM to 05:45 PM - Peak 1 of 1										
Intersection	04:45 PM									
Volume	329	3	332	0	5	358	363	3	3	6
Percent	99.1	0.9			1.4	98.6		50.0	50.0	
04:45 Volume	85	0	85	0	1	99	100	0	1	1
Peak Factor										0.942
High Int.	05:30 PM			3:45:00 PM	05:00 PM			05:00 PM		
Volume	93	0	93	0	1	103	104	2	0	2
Peak Factor			0.892				0.873			0.750
Peak Hour From 04:00 PM to 05:45 PM - Peak 1 of 1										
By Approach	04:45 PM			04:00 PM	04:15 PM			04:00 PM		
Volume	329	3	332	0	4	375	379	5	6	11
Percent	99.1	0.9			1.1	98.9		45.5	54.5	
High Int.	05:30 PM			-	05:00 PM			04:00 PM		
Volume	93	0	93	-	1	103	104	4	1	5
Peak Factor			0.892	-			0.911			0.550

TRAFFIC DATA, LLC

PO Box 187
 Cullman, AL 35056
 205-824-0125

File Name : mountainbrook05
 Site Code : 00000000
 Start Date : 03/23/2022
 Page No : 2

Start Time	CAHABA RD Southbound			App. Total	CAHABA RD Northbound			CHESTER RD Eastbound			Int. Total
	Thru	Right	App. Total		Left	Thru	App. Total	Left	Right	App. Total	
Peak Hour From 07:00 AM to 08:45 AM - Peak 1 of 1											
Intersection	07:30 AM										
Volume	322	2	324	0	2	264	266	7	4	11	601
Percent	99.4	0.6			0.8	99.2		63.6	36.4		
07:30 Volume	80	0	80	0	1	81	82	0	1	1	163
Peak Factor											0.922
High Int.	07:45 AM				07:30 AM			08:00 AM			
Volume	82	1	83	0	1	81	82	5	1	6	
Peak Factor			0.976				0.811			0.458	
Peak Hour From 07:00 AM to 08:45 AM - Peak 1 of 1											
By Approach	07:30 AM			07:00 AM	07:30 AM			07:45 AM			
Volume	322	2	324	0	2	264	266	8	4	12	
Percent	99.4	0.6			0.8	99.2		66.7	33.3		
High Int.	07:45 AM			-	07:30 AM			08:00 AM			
Volume	82	1	83	-	1	81	82	5	1	6	
Peak Factor			0.976	-			0.811			0.500	

TRAFFIC DATA, LLC

PO Box 187

Cullman, AL 35056

205-824-0125

Mountain Brook, AL

File Name : mountainbrook01

Site Code : 00000000

Start Date : 03/23/2022

Page No : 1

Groups Printed- Unshifted

Start Time	ORTHODONTICS Southbound			HOLLYWOOD BLVD Westbound			US 280 EXIT RAMP Northbound			HOLLYWOOD BLVD Eastbound			Int. Total
	Left	Thru	Right	Left	Thru	Right	Left	Thru	Right	Left	Thru	Right	
04:00 PM	0	0	0	0	140	0	22	0	32	0	56	0	250
04:15 PM	0	0	3	0	159	1	26	0	32	0	68	0	289
04:30 PM	1	0	1	0	130	1	21	0	35	1	50	0	240
04:45 PM	0	0	2	0	132	0	35	1	38	0	76	0	284
Total	1	0	6	0	561	2	104	1	137	1	250	0	1063
05:00 PM	0	0	0	0	144	0	20	0	43	0	66	0	273
05:15 PM	0	0	0	0	120	0	30	0	33	0	76	0	259
05:30 PM	0	0	0	0	147	0	27	0	40	0	59	0	273
05:45 PM	0	0	0	0	112	0	25	0	38	0	49	0	224
Total	0	0	0	0	523	0	102	0	154	0	250	0	1029
07:00 AM	0	0	0	0	89	0	16	0	17	0	36	0	158
07:15 AM	0	0	0	0	119	0	14	0	32	0	34	0	199
07:30 AM	1	0	0	0	148	0	21	0	38	0	35	0	243
07:45 AM	0	0	0	0	165	1	19	0	36	0	52	0	273
Total	1	0	0	0	521	1	70	0	123	0	157	0	873
08:00 AM	0	0	1	0	136	0	22	0	32	0	51	0	242
08:15 AM	0	0	0	0	146	0	28	0	28	0	45	0	247
08:30 AM	0	0	0	0	94	0	19	0	30	0	37	0	180
08:45 AM	1	0	0	0	131	0	46	0	46	1	52	0	277
Total	1	0	1	0	507	0	115	0	136	1	185	0	946
Grand Total	3	0	7	0	2112	3	391	1	550	2	842	0	3911
Apprch %	30.0	0.0	70.0	0.0	99.9	0.1	41.5	0.1	58.4	0.2	99.8	0.0	
Total %	0.1	0.0	0.2	0.0	54.0	0.1	10.0	0.0	14.1	0.1	21.5	0.0	

Start Time	ORTHODONTICS Southbound				HOLLYWOOD BLVD Westbound				US 280 EXIT RAMP Northbound				HOLLYWOOD BLVD Eastbound				Int. Total
	Left	Thru	Right	App. Total	Left	Thru	Right	App. Total	Left	Thru	Right	App. Total	Left	Thru	Right	App. Total	
Peak Hour From 04:00 PM to 05:45 PM - Peak 1 of 1																	
Intersection	04:45 PM				05:30 PM				04:45 PM				04:45 PM				
Volume	0	0	2	2	0	543	0	543	112	1	154	267	0	277	0	277	1089
Percent	0.0	0.0	100.0		0.0	100.0	0.0		41.9	0.4	57.7		0.0	100.0	0.0		
04:45	0	0	2	2	0	132	0	132	35	1	38	74	0	76	0	76	284
Volume																	0.959
Peak Factor				0.250				0.923				0.902					0.911
High Int. Volume	0	0	2	2	0	147	0	147	35	1	38	74	0	76	0	76	
Peak Factor																	
Peak Hour From 04:00 PM to 05:45 PM - Peak 1 of 1																	
By Approach	04:00 PM				04:15 PM				04:45 PM				04:45 PM				
Volume	1	0	6	7	0	565	2	567	112	1	154	267	0	277	0	277	
Percent	14.3	0.0	85.7		0.0	99.6	0.4		41.9	0.4	57.7		0.0	100.0	0.0		
High Int. Volume	0	0	3	3	0	159	1	160	35	1	38	74	0	76	0	76	
Peak Factor				0.583				0.886				0.902					0.911

TRAFFIC DATA, LLC

PO Box 187
 Cullman, AL 35056
 205-824-0125

File Name : mountainbrook01
 Site Code : 00000000
 Start Date : 03/23/2022
 Page No : 2

Start Time	ORTHODONTICS Southbound				HOLLYWOOD BLVD Westbound				US 280 EXIT RAMP Northbound				HOLLYWOOD BLVD Eastbound				Int. Total
	Left	Thru	Right	App. Total	Left	Thru	Right	App. Total	Left	Thru	Right	App. Total	Left	Thru	Right	App. Total	
Peak Hour From 07:00 AM to 08:45 AM - Peak 1 of 1																	
Intersection	07:30 AM																
Volume	1	0	1	2	0	595	1	596	90	0	134	224	0	183	0	183	1005
Percent	50.0	0.0	50.0		0.0	99.8	0.2		40.2	0.0	59.8		0.0	100.0	0.0		
07:45	07:30 AM																
Volume	0	0	0	0	0	165	1	166	19	0	36	55	0	52	0	52	273
Peak Factor	0.920																
High Int.	07:30 AM				07:45 AM				07:30 AM				07:45 AM				
Volume	1	0	0	1	0	165	1	166	21	0	38	59	0	52	0	52	
Peak Factor	0.500				0.898				0.949				0.880				
Peak Hour From 07:00 AM to 08:45 AM - Peak 1 of 1																	
By Approach	07:15 AM				07:30 AM				08:00 AM				08:00 AM				
Volume	1	0	1	2	0	595	1	596	115	0	136	251	1	185	0	186	
Percent	50.0	0.0	50.0		0.0	99.8	0.2		45.8	0.0	54.2		0.5	99.5	0.0		
High Int.	07:30 AM				07:45 AM				08:45 AM				08:45 AM				
Volume	1	0	0	1	0	165	1	166	46	0	46	92	1	52	0	53	
Peak Factor	0.500				0.898				0.682				0.877				

Appendix C

Machine Traffic Counts

TRAFFIC DATA, LLC
 PO Box 187, Cullman, AL 35056
 205-824-0125

Location: MONTEVALLO RD west of BROOKHILL
 City, State: MOUNTAIN BROOK, AL

Date: 3/23/2022
 Wednesday

24 Hour Volume															
24 Hour Volume							24 Hour Volume								
Begin	EB	WB	Combined	Begin	EB	WB	Combined	Begin	EB	WB	Combined	Begin	EB	WB	Combined
3:00 PM	108	378	149	634	257	1012	3:00 AM	0	1	1	6	1	7		
3:15 PM	91		171		262		3:15 AM	1		1		2			
3:30 PM	99		155		254		3:30 AM	0		1		1			
3:45 PM	80		159		239		3:45 AM	0		3		3			
4:00 PM	98	413	134	545	232	958	4:00 AM	4	13	0	10	4	23		
4:15 PM	101		158		259		4:15 AM	5		3		8			
4:30 PM	96		123		219		4:30 AM	2		5		7			
4:45 PM	118		130		248		4:45 AM	2		2		4			
5:00 PM	113	413	146	521	259	934	5:00 AM	9	53	4	61	13	114		
5:15 PM	113		130		243		5:15 AM	15		14		29			
5:30 PM	102		136		238		5:30 AM	11		14		25			
5:45 PM	85		109		194		5:45 AM	18		29		47			
6:00 PM	80	288	118	419	198	707	6:00 AM	19	111	27	185	46	296		
6:15 PM	79		112		191		6:15 AM	29		54		83			
6:30 PM	60		106		166		6:30 AM	21		45		66			
6:45 PM	69		83		152		6:45 AM	42		59		101			
7:00 PM	50	184	70	278	120	462	7:00 AM	51	277	92	518	143	795		
7:15 PM	50		85		135		7:15 AM	62		118		180			
7:30 PM	45		56		101		7:30 AM	76		137		213			
7:45 PM	39		67		106		7:45 AM	88		171		259			
8:00 PM	53	164	56	242	109	406	8:00 AM	85	323	134	500	219	823		
8:15 PM	49		79		128		8:15 AM	65		143		208			
8:30 PM	25		59		84		8:30 AM	75		100		175			
8:45 PM	37		48		85		8:45 AM	98		123		221			
9:00 PM	28	68	46	152	74	220	9:00 AM	85	343	117	477	202	820		
9:15 PM	20		53		73		9:15 AM	75		119		194			
9:30 PM	13		22		35		9:30 AM	83		120		203			
9:45 PM	7		31		38		9:45 AM	100		121		221			
10:00 PM	9	27	14	58	23	85	10:00 AM	98	379	108	487	206	866		
10:15 PM	3		26		29		10:15 AM	90		117		207			
10:30 PM	11		10		21		10:30 AM	89		129		218			
10:45 PM	4		8		12		10:45 AM	102		133		235			
11:00 PM	2	6	10	25	12	31	11:00 AM	106	410	114	578	220	988		
11:15 PM	1		4		5		11:15 AM	105		154		259			
11:30 PM	2		7		9		11:30 AM	107		144		251			
11:45 PM	1		4		5		11:45 AM	92		166		258			
3/24/2022 12:00 AM	0	4	1	8	1	12	12:00 PM	98	399	154	611	252	1010		
12:15 AM	0		2		2		12:15 PM	92		163		255			
12:30 AM	4		3		7		12:30 PM	85		142		227			
12:45 AM	0		2		2		12:45 PM	124		152		276			
1:00 AM	0	1	3	6	3	7	1:00 PM	98	415	180	674	278	1089		
1:15 AM	1		0		1		1:15 PM	119		185		304			
1:30 AM	0		1		1		1:30 PM	107		136		243			
1:45 AM	0		2		2		1:45 PM	91		173		264			
2:00 AM	0	0	3	7	3	7	2:00 PM	102	393	176	630	278	1023		
2:15 AM	0		1		1		2:15 PM	89		149		238			
2:30 AM	0		0		0		2:30 PM	106		161		267			
2:45 AM	0		3		3		2:45 PM	96		144		240			

24 Hour Volume EB 5063 (39.9%) WB 7632 (60.1%) Combined 12695

12:00 AM - 12:00 PM

12:00 PM - 12:00 AM

Count	EB	WB	Combined	EB	WB	Combined
	1915	2843	4758	3148	4789	7937
	40.2 %	59.8 %		39.7 %	60.3 %	
Peak Hour	10:45 AM	7:30 AM	11:00 AM	12:45 PM	1:00 PM	12:45 PM
Volume	420	585	988	448	674	1101
Factor	0.98	0.86	0.95	0.90	0.91	0.91

TRAFFIC DATA, LLC
 PO Box 187, Cullman, AL 35056
 205-824-0125

Location: CAHABA RD north of CHESTER RD
 City, State: MOUNTAIN BROOK, AL

Date: 3/23/2022
 Wednesday

24 Hour Volume															
24 Hour Volume							24 Hour Volume								
Begin	NB	SB	Combined	Begin	NB	SB	Combined	Begin	NB	SB	Combined	Begin	NB	SB	Combined
3:00 PM	105	406	71	281	176	687	3:00 AM	1	2	2	5	3	7		
3:15 PM	82		80		162		3:15 AM	0		0		0			
3:30 PM	100		69		169		3:30 AM	0		1		1			
3:45 PM	119		61		180		3:45 AM	1		2		3			
4:00 PM	104	405	65	291	169	696	4:00 AM	1	9	0	10	1	19		
4:15 PM	100		56		156		4:15 AM	4		6		10			
4:30 PM	89		82		171		4:30 AM	2		2		4			
4:45 PM	112		88		200		4:45 AM	2		2		4			
5:00 PM	118	391	67	322	185	713	5:00 AM	5	17	4	21	9	38		
5:15 PM	95		81		176		5:15 AM	4		3		7			
5:30 PM	87		99		186		5:30 AM	3		6		9			
5:45 PM	91		75		166		5:45 AM	5		8		13			
6:00 PM	79	285	53	178	132	463	6:00 AM	8	62	14	72	22	134		
6:15 PM	65		49		114		6:15 AM	16		15		31			
6:30 PM	75		47		122		6:30 AM	14		24		38			
6:45 PM	66		29		95		6:45 AM	24		19		43			
7:00 PM	65	203	32	139	97	342	7:00 AM	29	215	31	261	60	476		
7:15 PM	57		48		105		7:15 AM	39		59		98			
7:30 PM	38		26		64		7:30 AM	76		82		158			
7:45 PM	43		33		76		7:45 AM	71		89		160			
8:00 PM	33	107	28	102	61	209	8:00 AM	57	207	95	329	152	536		
8:15 PM	38		23		61		8:15 AM	54		92		146			
8:30 PM	20		27		47		8:30 AM	46		63		109			
8:45 PM	16		24		40		8:45 AM	50		79		129			
9:00 PM	25	72	23	58	48	130	9:00 AM	61	263	80	296	141	559		
9:15 PM	23		15		38		9:15 AM	64		61		125			
9:30 PM	14		12		26		9:30 AM	81		83		164			
9:45 PM	10		8		18		9:45 AM	57		72		129			
10:00 PM	19	38	12	24	31	62	10:00 AM	61	277	71	270	132	547		
10:15 PM	10		2		12		10:15 AM	72		52		124			
10:30 PM	4		4		8		10:30 AM	65		62		127			
10:45 PM	5		6		11		10:45 AM	79		85		164			
11:00 PM	3	4	3	8	6	12	11:00 AM	73	398	83	328	156	726		
11:15 PM	0		3		3		11:15 AM	97		92		189			
11:30 PM	0		1		1		11:30 AM	114		70		184			
11:45 PM	1		1		2		11:45 AM	114		83		197			
3/24/2022 12:00 AM	0	2	0	3	0	5	12:00 PM	102	420	81	347	183	767		
12:15 AM	2		3		5		12:15 PM	101		74		175			
12:30 AM	0		0		0		12:30 PM	102		89		191			
12:45 AM	0		0		0		12:45 PM	115		103		218			
1:00 AM	0	2	0	0	0	2	1:00 PM	85	364	80	352	165	716		
1:15 AM	0		0		0		1:15 PM	90		115		205			
1:30 AM	1		0		1		1:30 PM	96		79		175			
1:45 AM	1		0		1		1:45 PM	93		78		171			
2:00 AM	0	0	0	0	0	0	2:00 PM	95	385	90	325	185	710		
2:15 AM	0		0		0		2:15 PM	99		83		182			
2:30 AM	0		0		0		2:30 PM	81		83		164			
2:45 AM	0		0		0		2:45 PM	110		69		179			

24 Hour Volume NB 4534 (53.0%) SB 4022 (47.0%) Combined 8556

	NB	SB	Combined
Count	1454	1595	3049
Peak Hour	11:00 AM	7:30 AM	11:00 AM
Volume	398	358	726
Factor	0.87	0.94	0.92

	NB	SB	Combined
Count	3080	2427	5507
Peak Hour	3:30 PM	12:30 PM	12:30 PM
Volume	423	387	779
Factor	0.89	0.84	0.89

Appendix D

Existing Intersection Capacity Analysis Worksheets

HCM Unsignalized Intersection Capacity Analysis

1: US-280 Entrance Ramp & Hollywood Blvd



Movement	EBT	EBR	WBL	WBT	NBL	NBR
Lane Configurations	↻			↻		
Traffic Volume (veh/h)	187	154	441	214	0	0
Future Volume (Veh/h)	187	154	441	214	0	0
Sign Control	Free			Free	Stop	
Grade	0%			0%	0%	
Peak Hour Factor	0.82	0.82	0.91	0.91	0.92	0.92
Hourly flow rate (vph)	228	188	485	235	0	0
Pedestrians						
Lane Width (ft)						
Walking Speed (ft/s)						
Percent Blockage						
Right turn flare (veh)						
Median type	None			None		
Median storage (veh)						
Upstream signal (ft)						
pX, platoon unblocked						
vC, conflicting volume			228		1527	322
vC1, stage 1 conf vol						
vC2, stage 2 conf vol						
vCu, unblocked vol			228		1527	322
tC, single (s)			4.1		6.4	6.2
tC, 2 stage (s)						
tF (s)			2.2		3.5	3.3
p0 queue free %			63		100	100
cM capacity (veh/h)			1328		81	714
Direction, Lane #						
	EB 1	WB 1				
Volume Total	416	720				
Volume Left	0	485				
Volume Right	188	0				
cSH	1700	1328				
Volume to Capacity	0.24	0.37				
Queue Length 95th (ft)	0	42				
Control Delay (s)	0.0	7.5				
Lane LOS		A				
Approach Delay (s)	0.0	7.5				
Approach LOS						
Intersection Summary						
Average Delay			4.8			
Intersection Capacity Utilization			61.6%	ICU Level of Service	B	
Analysis Period (min)			15			

HCM Unsignalized Intersection Capacity Analysis

2: US-280 Exit Ramp & Hollywood Blvd/Montevallo Road

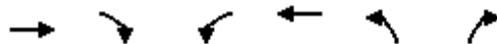

Movement	EBT	EBR	WBL	WBT	NBL	NBR
Lane Configurations	↑			↑	↘	↘
Traffic Volume (veh/h)	183	0	0	595	90	134
Future Volume (Veh/h)	183	0	0	595	90	134
Sign Control	Free			Free	Stop	
Grade	0%			0%	0%	
Peak Hour Factor	0.88	0.88	0.90	0.90	0.95	0.95
Hourly flow rate (vph)	208	0	0	661	95	141
Pedestrians						
Lane Width (ft)						
Walking Speed (ft/s)						
Percent Blockage						
Right turn flare (veh)						
Median type	None			None		
Median storage (veh)						
Upstream signal (ft)						
pX, platoon unblocked						
vC, conflicting volume			208			869 208
vC1, stage 1 conf vol						
vC2, stage 2 conf vol						
vCu, unblocked vol			208			869 208
tC, single (s)			4.1			6.4 6.2
tC, 2 stage (s)						
tF (s)			2.2			3.5 3.3
p0 queue free %			100			70 83
cM capacity (veh/h)			1351			320 827
Direction, Lane #	EB 1	WB 1	NB 1	NB 2		
Volume Total	208	661	95	141		
Volume Left	0	0	95	0		
Volume Right	0	0	0	141		
cSH	1700	1700	320	827		
Volume to Capacity	0.12	0.39	0.30	0.17		
Queue Length 95th (ft)	0	0	30	15		
Control Delay (s)	0.0	0.0	20.9	10.2		
Lane LOS			C	B		
Approach Delay (s)	0.0	0.0	14.6			
Approach LOS			B			
Intersection Summary						
Average Delay			3.1			
Intersection Capacity Utilization			43.0%	ICU Level of Service		A
Analysis Period (min)			15			

3: Montevallo Road & Brookhill

03/30/2022

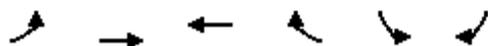

Movement	EBL	EBT	WBT	WBR	SBL	SBR
Lane Configurations						
Traffic Volume (veh/h)	2	302	588	3	5	5
Future Volume (Veh/h)	2	302	588	3	5	5
Sign Control		Free	Free		Stop	
Grade		0%	0%		0%	
Peak Hour Factor	0.91	0.91	0.86	0.86	0.50	0.50
Hourly flow rate (vph)	2	332	684	3	10	10
Pedestrians						
Lane Width (ft)						
Walking Speed (ft/s)						
Percent Blockage						
Right turn flare (veh)						
Median type		None	None			
Median storage (veh)						
Upstream signal (ft)			801			
pX, platoon unblocked	0.92				0.92	0.92
vC, conflicting volume	687				1022	686
vC1, stage 1 conf vol						
vC2, stage 2 conf vol						
vCu, unblocked vol	613				978	611
tC, single (s)	4.1				6.4	6.2
tC, 2 stage (s)						
tF (s)	2.2				3.5	3.3
p0 queue free %	100				96	98
cM capacity (veh/h)	877				252	449

Direction, Lane #	EB 1	EB 2	WB 1	SB 1
Volume Total	2	332	687	20
Volume Left	2	0	0	10
Volume Right	0	0	3	10
cSH	877	1700	1700	323
Volume to Capacity	0.00	0.20	0.40	0.06
Queue Length 95th (ft)	0	0	0	5
Control Delay (s)	9.1	0.0	0.0	16.9
Lane LOS	A			C
Approach Delay (s)	0.1		0.0	16.9
Approach LOS				C

Intersection Summary			
Average Delay		0.3	
Intersection Capacity Utilization		41.1%	ICU Level of Service
Analysis Period (min)		15	A

HCM Signalized Intersection Capacity Analysis

4: Cahaba Road & Montevallo Road



Movement	EBL	EBT	EBR	WBL	WBT	WBR	NBL	NBT	NBR	SBL	SBT	SBR
Lane Configurations												
Traffic Volume (vph)	73	169	35	48	291	1	58	158	48	10	227	217
Future Volume (vph)	73	169	35	48	291	1	58	158	48	10	227	217
Ideal Flow (vphpl)	1900	1900	1900	1900	1900	1900	1900	1900	1900	1900	1900	1900
Total Lost time (s)	4.5	4.5		4.5	4.5		4.5	4.5		4.5	4.5	
Lane Util. Factor	1.00	1.00		1.00	1.00		1.00	1.00		1.00	1.00	
Frt	1.00	0.97		1.00	1.00		1.00	0.96		1.00	0.93	
Flt Protected	0.95	1.00		0.95	1.00		0.95	1.00		0.95	1.00	
Satd. Flow (prot)	1736	1780		1736	1826		1736	1763		1736	1693	
Flt Permitted	0.49	1.00		0.61	1.00		0.38	1.00		0.61	1.00	
Satd. Flow (perm)	896	1780		1108	1826		690	1763		1119	1693	
Peak-hour factor, PHF	0.83	0.83	0.83	0.86	0.86	0.86	0.88	0.88	0.88	0.94	0.94	0.94
Adj. Flow (vph)	88	204	42	56	338	1	66	180	55	11	241	231
RTOR Reduction (vph)	0	10	0	0	0	0	0	17	0	0	54	0
Lane Group Flow (vph)	88	236	0	56	339	0	66	218	0	11	418	0
Turn Type	Perm	NA		Perm	NA		Perm	NA		Perm	NA	
Protected Phases		4			4			2			2	
Permitted Phases	4			4			2			2		
Actuated Green, G (s)	15.8	15.8		15.8	15.8		18.5	18.5		18.5	18.5	
Effective Green, g (s)	15.8	15.8		15.8	15.8		18.5	18.5		18.5	18.5	
Actuated g/C Ratio	0.36	0.36		0.36	0.36		0.43	0.43		0.43	0.43	
Clearance Time (s)	4.5	4.5		4.5	4.5		4.5	4.5		4.5	4.5	
Vehicle Extension (s)	3.0	3.0		3.0	3.0		3.0	3.0		3.0	3.0	
Lane Grp Cap (vph)	326	649		404	666		294	753		478	723	
v/s Ratio Prot		0.13			c0.19			0.12			c0.25	
v/s Ratio Perm	0.10			0.05			0.10			0.01		
v/c Ratio	0.27	0.36		0.14	0.51		0.22	0.29		0.02	0.58	
Uniform Delay, d1	9.7	10.1		9.2	10.7		7.9	8.1		7.2	9.4	
Progression Factor	1.00	1.00		1.00	1.00		1.00	1.00		1.00	1.00	
Incremental Delay, d2	0.4	0.3		0.2	0.6		0.4	0.2		0.0	1.1	
Delay (s)	10.1	10.4		9.4	11.3		8.2	8.3		7.2	10.6	
Level of Service	B	B		A	B		A	A		A	B	
Approach Delay (s)		10.3			11.1			8.3			10.5	
Approach LOS		B			B			A			B	

Intersection Summary

HCM 2000 Control Delay	10.2	HCM 2000 Level of Service	B
HCM 2000 Volume to Capacity ratio	0.55		
Actuated Cycle Length (s)	43.3	Sum of lost time (s)	9.0
Intersection Capacity Utilization	63.9%	ICU Level of Service	B
Analysis Period (min)	15		

c Critical Lane Group

HCM Unsignalized Intersection Capacity Analysis

5: Cahaba Road & Chester Road



Movement	EBL	EBR	NBL	NBT	SBT	SBR
Lane Configurations						
Traffic Volume (veh/h)	7	4	2	264	322	2
Future Volume (Veh/h)	7	4	2	264	322	2
Sign Control	Stop			Free	Free	
Grade	0%			0%	0%	
Peak Hour Factor	0.46	0.46	0.81	0.81	0.98	0.98
Hourly flow rate (vph)	15	9	2	326	329	2
Pedestrians						
Lane Width (ft)						
Walking Speed (ft/s)						
Percent Blockage						
Right turn flare (veh)						
Median type				None	None	
Median storage (veh)						
Upstream signal (ft)					605	
pX, platoon unblocked						
vC, conflicting volume	660	330	331			
vC1, stage 1 conf vol						
vC2, stage 2 conf vol						
vCu, unblocked vol	660	330	331			
tC, single (s)	6.4	6.2	4.1			
tC, 2 stage (s)						
tF (s)	3.5	3.3	2.2			
p0 queue free %	96	99	100			
cM capacity (veh/h)	424	707	1217			
Direction, Lane #	EB 1	NB 1	NB 2	SB 1		
Volume Total	24	2	326	331		
Volume Left	15	2	0	0		
Volume Right	9	0	0	2		
cSH	499	1217	1700	1700		
Volume to Capacity	0.05	0.00	0.19	0.19		
Queue Length 95th (ft)	4	0	0	0		
Control Delay (s)	12.6	8.0	0.0	0.0		
Lane LOS	B	A				
Approach Delay (s)	12.6	0.0		0.0		
Approach LOS	B					
Intersection Summary						
Average Delay			0.5			
Intersection Capacity Utilization			27.1%	ICU Level of Service	A	
Analysis Period (min)			15			

HCM Unsignalized Intersection Capacity Analysis

1: US-280 Entrance Ramp & Hollywood Blvd

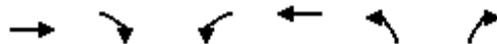

Movement	EBT	EBR	WBL	WBT	NBL	NBR
Lane Configurations						
Traffic Volume (veh/h)	280	178	378	315	0	0
Future Volume (Veh/h)	280	178	378	315	0	0
Sign Control	Free			Free	Stop	
Grade	0%			0%	0%	
Peak Hour Factor	0.95	0.95	0.92	0.92	0.92	0.92
Hourly flow rate (vph)	295	187	411	342	0	0
Pedestrians						
Lane Width (ft)						
Walking Speed (ft/s)						
Percent Blockage						
Right turn flare (veh)						
Median type	None		None			
Median storage (veh)						
Upstream signal (ft)						
pX, platoon unblocked						
vC, conflicting volume			295	1552	388	
vC1, stage 1 conf vol						
vC2, stage 2 conf vol						
vCu, unblocked vol			295	1552	388	
tC, single (s)			4.1	6.4	6.2	
tC, 2 stage (s)						
tF (s)			2.2	3.5	3.3	
p0 queue free %			67	100	100	
cM capacity (veh/h)			1255	83	655	
Direction, Lane #	EB 1	WB 1				
Volume Total	482	753				
Volume Left	0	411				
Volume Right	187	0				
cSH	1700	1255				
Volume to Capacity	0.28	0.33				
Queue Length 95th (ft)	0	36				
Control Delay (s)	0.0	6.8				
Lane LOS			A			
Approach Delay (s)	0.0	6.8				
Approach LOS						
Intersection Summary						
Average Delay			4.1			
Intersection Capacity Utilization			69.8%	ICU Level of Service	C	
Analysis Period (min)			15			

HCM Unsignalized Intersection Capacity Analysis

2: US-280 Exit Ramp & Hollywood Blvd/Montevallo Road

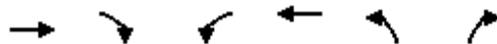

Movement	EBT	EBR	WBL	WBT	NBL	NBR
Lane Configurations	↑			↑	↘	↗
Traffic Volume (veh/h)	277	0	0	543	112	154
Future Volume (Veh/h)	277	0	0	543	112	154
Sign Control	Free			Free	Stop	
Grade	0%			0%	0%	
Peak Hour Factor	0.91	0.91	0.92	0.92	0.90	0.90
Hourly flow rate (vph)	304	0	0	590	124	171
Pedestrians						
Lane Width (ft)						
Walking Speed (ft/s)						
Percent Blockage						
Right turn flare (veh)						
Median type	None		None			
Median storage (veh)						
Upstream signal (ft)						
pX, platoon unblocked						
vC, conflicting volume			304		894	304
vC1, stage 1 conf vol						
vC2, stage 2 conf vol						
vCu, unblocked vol			304		894	304
tC, single (s)			4.1		6.4	6.2
tC, 2 stage (s)						
tF (s)			2.2		3.5	3.3
p0 queue free %			100		60	77
cM capacity (veh/h)			1246		309	731
Direction, Lane #	EB 1	WB 1	NB 1	NB 2		
Volume Total	304	590	124	171		
Volume Left	0	0	124	0		
Volume Right	0	0	0	171		
cSH	1700	1700	309	731		
Volume to Capacity	0.18	0.35	0.40	0.23		
Queue Length 95th (ft)	0	0	47	23		
Control Delay (s)	0.0	0.0	24.2	11.4		
Lane LOS			C	B		
Approach Delay (s)	0.0	0.0	16.8			
Approach LOS			C			
Intersection Summary						
Average Delay			4.2			
Intersection Capacity Utilization			41.5%	ICU Level of Service		A
Analysis Period (min)			15			

HCM Unsignalized Intersection Capacity Analysis

3: Montevillo Road & Brookhill



Movement	EBL	EBT	WBT	WBR	SBL	SBR
Lane Configurations						
Traffic Volume (veh/h)	8	418	568	5	7	13
Future Volume (Veh/h)	8	418	568	5	7	13
Sign Control		Free	Free		Stop	
Grade		0%	0%		0%	
Peak Hour Factor	0.87	0.87	0.89	0.89	0.63	0.63
Hourly flow rate (vph)	9	480	638	6	11	21
Pedestrians						
Lane Width (ft)						
Walking Speed (ft/s)						
Percent Blockage						
Right turn flare (veh)						
Median type		None	None			
Median storage (veh)						
Upstream signal (ft)			801			
pX, platoon unblocked	0.97				0.97	0.97
vC, conflicting volume	644				1139	641
vC1, stage 1 conf vol						
vC2, stage 2 conf vol						
vCu, unblocked vol	620				1129	617
tC, single (s)	4.1				6.4	6.2
tC, 2 stage (s)						
tF (s)	2.2				3.5	3.3
p0 queue free %	99				95	96
cM capacity (veh/h)	925				215	473

Direction, Lane #	EB 1	EB 2	WB 1	SB 1
Volume Total	9	480	644	32
Volume Left	9	0	0	11
Volume Right	0	0	6	21
cSH	925	1700	1700	335
Volume to Capacity	0.01	0.28	0.38	0.10
Queue Length 95th (ft)	1	0	0	8
Control Delay (s)	8.9	0.0	0.0	16.9
Lane LOS	A			C
Approach Delay (s)	0.2		0.0	16.9
Approach LOS				C

Intersection Summary			
Average Delay		0.5	
Intersection Capacity Utilization		40.2%	ICU Level of Service
Analysis Period (min)		15	A

HCM Signalized Intersection Capacity Analysis

4: Cahaba Road & Montevallo Road



Movement	EBL	EBT	EBR	WBL	WBT	WBR	NBL	NBT	NBR	SBL	SBT	SBR
Lane Configurations												
Traffic Volume (vph)	101	315	40	48	232	1	59	234	111	23	220	217
Future Volume (vph)	101	315	40	48	232	1	59	234	111	23	220	217
Ideal Flow (vphpl)	1900	1900	1900	1900	1900	1900	1900	1900	1900	1900	1900	1900
Total Lost time (s)	4.5	4.5		4.5	4.5		4.5	4.5		4.5	4.5	
Lane Util. Factor	1.00	1.00		1.00	1.00		1.00	1.00		1.00	1.00	
Frt	1.00	0.98		1.00	1.00		1.00	0.95		1.00	0.93	
Flt Protected	0.95	1.00		0.95	1.00		0.95	1.00		0.95	1.00	
Satd. Flow (prot)	1736	1796		1736	1826		1736	1739		1736	1691	
Flt Permitted	0.57	1.00		0.43	1.00		0.36	1.00		0.47	1.00	
Satd. Flow (perm)	1038	1796		777	1826		655	1739		852	1691	
Peak-hour factor, PHF	0.93	0.93	0.93	0.87	0.87	0.87	0.90	0.90	0.90	0.89	0.89	0.89
Adj. Flow (vph)	109	339	43	55	267	1	66	260	123	26	247	244
RTOR Reduction (vph)	0	6	0	0	0	0	0	25	0	0	53	0
Lane Group Flow (vph)	109	376	0	55	268	0	66	358	0	26	438	0
Turn Type	Perm	NA		Perm	NA		Perm	NA		Perm	NA	
Protected Phases		4			4			2			2	
Permitted Phases	4			4			2			2		
Actuated Green, G (s)	17.6	17.6		17.6	17.6		21.1	21.1		21.1	21.1	
Effective Green, g (s)	17.6	17.6		17.6	17.6		21.1	21.1		21.1	21.1	
Actuated g/C Ratio	0.37	0.37		0.37	0.37		0.44	0.44		0.44	0.44	
Clearance Time (s)	4.5	4.5		4.5	4.5		4.5	4.5		4.5	4.5	
Vehicle Extension (s)	3.0	3.0		3.0	3.0		3.0	3.0		3.0	3.0	
Lane Grp Cap (vph)	382	662		286	673		289	769		376	748	
v/s Ratio Prot		c0.21			0.15			0.21			c0.26	
v/s Ratio Perm	0.10			0.07			0.10			0.03		
v/c Ratio	0.29	0.57		0.19	0.40		0.23	0.47		0.07	0.59	
Uniform Delay, d1	10.6	12.0		10.2	11.1		8.3	9.3		7.7	10.0	
Progression Factor	1.00	1.00		1.00	1.00		1.00	1.00		1.00	1.00	
Incremental Delay, d2	0.4	1.1		0.3	0.4		0.4	0.4		0.1	1.2	
Delay (s)	11.0	13.1		10.6	11.5		8.7	9.8		7.7	11.2	
Level of Service	B	B		B	B		A	A		A	B	
Approach Delay (s)		12.7			11.4			9.6			11.0	
Approach LOS		B			B			A			B	

Intersection Summary

HCM 2000 Control Delay	11.2	HCM 2000 Level of Service	B
HCM 2000 Volume to Capacity ratio	0.58		
Actuated Cycle Length (s)	47.7	Sum of lost time (s)	9.0
Intersection Capacity Utilization	67.2%	ICU Level of Service	C
Analysis Period (min)	15		

c Critical Lane Group

HCM Unsignalized Intersection Capacity Analysis

5: Cahaba Road & Chester Road



Movement	EBL	EBR	NBL	NBT	SBT	SBR
Lane Configurations						
Traffic Volume (veh/h)	3	3	5	358	329	3
Future Volume (Veh/h)	3	3	5	358	329	3
Sign Control	Stop			Free	Free	
Grade	0%			0%	0%	
Peak Hour Factor	0.75	0.75	0.87	0.87	0.89	0.89
Hourly flow rate (vph)	4	4	6	411	370	3
Pedestrians						
Lane Width (ft)						
Walking Speed (ft/s)						
Percent Blockage						
Right turn flare (veh)						
Median type				None	None	
Median storage (veh)						
Upstream signal (ft)					605	
pX, platoon unblocked						
vC, conflicting volume	794	372	373			
vC1, stage 1 conf vol						
vC2, stage 2 conf vol						
vCu, unblocked vol	794	372	373			
tC, single (s)	6.4	6.2	4.1			
tC, 2 stage (s)						
tF (s)	3.5	3.3	2.2			
p0 queue free %	99	99	99			
cM capacity (veh/h)	352	670	1175			
Direction, Lane #	EB 1	NB 1	NB 2	SB 1		
Volume Total	8	6	411	373		
Volume Left	4	6	0	0		
Volume Right	4	0	0	3		
cSH	462	1175	1700	1700		
Volume to Capacity	0.02	0.01	0.24	0.22		
Queue Length 95th (ft)	1	0	0	0		
Control Delay (s)	12.9	8.1	0.0	0.0		
Lane LOS	B	A				
Approach Delay (s)	12.9	0.1		0.0		
Approach LOS	B					
Intersection Summary						
Average Delay			0.2			
Intersection Capacity Utilization			28.8%		ICU Level of Service	A
Analysis Period (min)			15			

Appendix E

Background 2025 Intersection Capacity Analysis Worksheets

HCM Unsignalized Intersection Capacity Analysis

1: US-280 Entrance Ramp & Hollywood Blvd

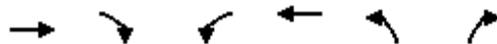

Movement	EBT	EBR	WBL	WBT	NBL	NBR
Lane Configurations	↻		↻	↻		
Traffic Volume (veh/h)	190	156	448	217	0	0
Future Volume (Veh/h)	190	156	448	217	0	0
Sign Control	Free			Free	Stop	
Grade	0%			0%	0%	
Peak Hour Factor	0.82	0.82	0.91	0.91	0.92	0.92
Hourly flow rate (vph)	232	190	492	238	0	0
Pedestrians						
Lane Width (ft)						
Walking Speed (ft/s)						
Percent Blockage						
Right turn flare (veh)						
Median type	None		None			
Median storage (veh)						
Upstream signal (ft)	260					
pX, platoon unblocked						
vC, conflicting volume			232		1549	327
vC1, stage 1 conf vol						
vC2, stage 2 conf vol						
vCu, unblocked vol			232		1549	327
tC, single (s)			4.1		6.4	6.2
tC, 2 stage (s)						
tF (s)			2.2		3.5	3.3
p0 queue free %			63		100	100
cM capacity (veh/h)			1324		78	710
Direction, Lane #	EB 1	WB 1	WB 2			
Volume Total	422	492	238			
Volume Left	0	492	0			
Volume Right	190	0	0			
cSH	1700	1324	1700			
Volume to Capacity	0.25	0.37	0.14			
Queue Length 95th (ft)	0	44	0			
Control Delay (s)	0.0	9.3	0.0			
Lane LOS	A					
Approach Delay (s)	0.0	6.3				
Approach LOS						
Intersection Summary						
Average Delay	4.0					
Intersection Capacity Utilization	51.0%		ICU Level of Service			A
Analysis Period (min)	15					

HCM Signalized Intersection Capacity Analysis

2: US-280 Exit Ramp & Hollywood Blvd/Montevallo Road



Movement	EBT	EBR	WBL	WBT	NBL	NBR
Lane Configurations	↑			↑	↘	↗
Traffic Volume (vph)	186	0	0	604	91	136
Future Volume (vph)	186	0	0	604	91	136
Ideal Flow (vphpl)	1900	1900	1900	1900	1900	1900
Total Lost time (s)	4.5			4.5	4.5	4.5
Lane Util. Factor	1.00			1.00	1.00	1.00
Frt	1.00			1.00	1.00	0.85
Flt Protected	1.00			1.00	0.95	1.00
Satd. Flow (prot)	1827			1827	1736	1553
Flt Permitted	1.00			1.00	0.95	1.00
Satd. Flow (perm)	1827			1827	1736	1553
Peak-hour factor, PHF	0.88	0.88	0.90	0.90	0.95	0.95
Adj. Flow (vph)	211	0	0	671	96	143
RTOR Reduction (vph)	0	0	0	0	0	121
Lane Group Flow (vph)	211	0	0	671	96	22
Turn Type	NA			NA	Prot	Perm
Protected Phases	2			2	4	
Permitted Phases						4
Actuated Green, G (s)	25.4			25.4	6.4	6.4
Effective Green, g (s)	25.4			25.4	6.4	6.4
Actuated g/C Ratio	0.62			0.62	0.16	0.16
Clearance Time (s)	4.5			4.5	4.5	4.5
Vehicle Extension (s)	3.0			3.0	3.0	3.0
Lane Grp Cap (vph)	1137			1137	272	243
v/s Ratio Prot	0.12			c0.37	c0.06	
v/s Ratio Perm						0.01
v/c Ratio	0.19			0.59	0.35	0.09
Uniform Delay, d1	3.3			4.6	15.4	14.7
Progression Factor	1.00			1.00	1.00	1.00
Incremental Delay, d2	0.1			0.8	0.8	0.2
Delay (s)	3.4			5.4	16.1	14.9
Level of Service	A			A	B	B
Approach Delay (s)	3.4			5.4	15.4	
Approach LOS	A			A	B	

Intersection Summary			
HCM 2000 Control Delay	7.2	HCM 2000 Level of Service	A
HCM 2000 Volume to Capacity ratio	0.54		
Actuated Cycle Length (s)	40.8	Sum of lost time (s)	9.0
Intersection Capacity Utilization	51.0%	ICU Level of Service	A
Analysis Period (min)	15		

c Critical Lane Group

3: Montevallo Road & Brookhill

03/31/2022

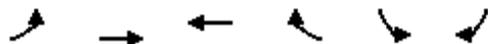

Movement	EBL	EBT	WBT	WBR	SBL	SBR
Lane Configurations						
Traffic Volume (veh/h)	2	307	597	3	5	5
Future Volume (Veh/h)	2	307	597	3	5	5
Sign Control		Free	Free		Stop	
Grade		0%	0%		0%	
Peak Hour Factor	0.91	0.91	0.86	0.86	0.50	0.50
Hourly flow rate (vph)	2	337	694	3	10	10
Pedestrians						
Lane Width (ft)						
Walking Speed (ft/s)						
Percent Blockage						
Right turn flare (veh)						
Median type		None	None			
Median storage (veh)						
Upstream signal (ft)		1280	801			
pX, platoon unblocked	0.93				0.93	0.93
vC, conflicting volume	697				1036	696
vC1, stage 1 conf vol						
vC2, stage 2 conf vol						
vCu, unblocked vol	634				1000	633
tC, single (s)	4.1				6.4	6.2
tC, 2 stage (s)						
tF (s)	2.2				3.5	3.3
p0 queue free %	100				96	98
cM capacity (veh/h)	871				247	442
Direction, Lane #	EB 1	EB 2	WB 1	SB 1		
Volume Total	2	337	697	20		
Volume Left	2	0	0	10		
Volume Right	0	0	3	10		
cSH	871	1700	1700	317		
Volume to Capacity	0.00	0.20	0.41	0.06		
Queue Length 95th (ft)	0	0	0	5		
Control Delay (s)	9.1	0.0	0.0	17.1		
Lane LOS	A			C		
Approach Delay (s)	0.1		0.0	17.1		
Approach LOS				C		
Intersection Summary						
Average Delay			0.3			
Intersection Capacity Utilization			41.6%		ICU Level of Service	A
Analysis Period (min)			15			

HCM Signalized Intersection Capacity Analysis

4: Cahaba Road & Montevallo Road



Movement	EBL	EBT	EBR	WBL	WBT	WBR	NBL	NBT	NBR	SBL	SBT	SBR
Lane Configurations												
Traffic Volume (vph)	74	172	36	49	285	1	59	160	49	10	230	220
Future Volume (vph)	74	172	36	49	285	1	59	160	49	10	230	220
Ideal Flow (vphpl)	1900	1900	1900	1900	1900	1900	1900	1900	1900	1900	1900	1900
Total Lost time (s)	4.5	4.5		4.5	4.5		4.5	4.5		4.5	4.5	
Lane Util. Factor	1.00	1.00		1.00	1.00		1.00	1.00		1.00	1.00	
Frt	1.00	0.97		1.00	1.00		1.00	0.96		1.00	0.93	
Flt Protected	0.95	1.00		0.95	1.00		0.95	1.00		0.95	1.00	
Satd. Flow (prot)	1736	1780		1736	1826		1736	1762		1736	1693	
Flt Permitted	0.50	1.00		0.60	1.00		0.37	1.00		0.61	1.00	
Satd. Flow (perm)	909	1780		1103	1826		681	1762		1116	1693	
Peak-hour factor, PHF	0.83	0.83	0.83	0.86	0.86	0.86	0.88	0.88	0.88	0.94	0.94	0.94
Adj. Flow (vph)	89	207	43	57	331	1	67	182	56	11	245	234
RTOR Reduction (vph)	0	10	0	0	0	0	0	17	0	0	53	0
Lane Group Flow (vph)	89	240	0	57	332	0	67	221	0	11	426	0
Turn Type	Perm	NA		Perm	NA		Perm	NA		Perm	NA	
Protected Phases		4			4			2			2	
Permitted Phases	4			4			2			2		
Actuated Green, G (s)	15.7	15.7		15.7	15.7		18.7	18.7		18.7	18.7	
Effective Green, g (s)	15.7	15.7		15.7	15.7		18.7	18.7		18.7	18.7	
Actuated g/C Ratio	0.36	0.36		0.36	0.36		0.43	0.43		0.43	0.43	
Clearance Time (s)	4.5	4.5		4.5	4.5		4.5	4.5		4.5	4.5	
Vehicle Extension (s)	3.0	3.0		3.0	3.0		3.0	3.0		3.0	3.0	
Lane Grp Cap (vph)	328	643		399	660		293	759		480	729	
v/s Ratio Prot		0.13			c0.18			0.13			c0.25	
v/s Ratio Perm	0.10			0.05			0.10			0.01		
v/c Ratio	0.27	0.37		0.14	0.50		0.23	0.29		0.02	0.58	
Uniform Delay, d1	9.8	10.2		9.3	10.8		7.8	8.0		7.1	9.4	
Progression Factor	1.00	1.00		1.00	1.00		1.00	1.00		1.00	1.00	
Incremental Delay, d2	0.4	0.4		0.2	0.6		0.4	0.2		0.0	1.2	
Delay (s)	10.3	10.6		9.5	11.4		8.2	8.3		7.1	10.6	
Level of Service	B	B		A	B		A	A		A	B	
Approach Delay (s)		10.5			11.1			8.2			10.5	
Approach LOS		B			B			A			B	

Intersection Summary

HCM 2000 Control Delay	10.2	HCM 2000 Level of Service	B
HCM 2000 Volume to Capacity ratio	0.55		
Actuated Cycle Length (s)	43.4	Sum of lost time (s)	9.0
Intersection Capacity Utilization	64.0%	ICU Level of Service	B
Analysis Period (min)	15		

c Critical Lane Group

HCM Unsignalized Intersection Capacity Analysis

5: Cahaba Road & Chester Road



Movement	EBL	EBR	NBL	NBT	SBT	SBR
Lane Configurations						
Traffic Volume (veh/h)	7	4	2	268	327	2
Future Volume (Veh/h)	7	4	2	268	327	2
Sign Control	Stop			Free	Free	
Grade	0%			0%	0%	
Peak Hour Factor	0.46	0.46	0.81	0.81	0.98	0.98
Hourly flow rate (vph)	15	9	2	331	334	2
Pedestrians						
Lane Width (ft)						
Walking Speed (ft/s)						
Percent Blockage						
Right turn flare (veh)						
Median type				None	None	
Median storage (veh)						
Upstream signal (ft)					605	
pX, platoon unblocked						
vC, conflicting volume	670	335	336			
vC1, stage 1 conf vol						
vC2, stage 2 conf vol						
vCu, unblocked vol	670	335	336			
tC, single (s)	6.4	6.2	4.1			
tC, 2 stage (s)						
tF (s)	3.5	3.3	2.2			
p0 queue free %	96	99	100			
cM capacity (veh/h)	418	702	1212			
Direction, Lane #	EB 1	NB 1	NB 2	SB 1		
Volume Total	24	2	331	336		
Volume Left	15	2	0	0		
Volume Right	9	0	0	2		
cSH	493	1212	1700	1700		
Volume to Capacity	0.05	0.00	0.19	0.20		
Queue Length 95th (ft)	4	0	0	0		
Control Delay (s)	12.7	8.0	0.0	0.0		
Lane LOS	B	A				
Approach Delay (s)	12.7	0.0		0.0		
Approach LOS	B					
Intersection Summary						
Average Delay			0.5			
Intersection Capacity Utilization			27.3%	ICU Level of Service	A	
Analysis Period (min)			15			

HCM Unsignalized Intersection Capacity Analysis

1: US-280 Entrance Ramp & Hollywood Blvd



Movement	EBT	EBR	WBL	WBT	NBL	NBR
Lane Configurations	↻		↻	↻		
Traffic Volume (veh/h)	284	181	384	320	0	0
Future Volume (Veh/h)	284	181	384	320	0	0
Sign Control	Free			Free	Stop	
Grade	0%			0%	0%	
Peak Hour Factor	0.95	0.95	0.92	0.92	0.92	0.92
Hourly flow rate (vph)	299	191	417	348	0	0
Pedestrians						
Lane Width (ft)						
Walking Speed (ft/s)						
Percent Blockage						
Right turn flare (veh)						
Median type	None		None			
Median storage (veh)						
Upstream signal (ft)	260					
pX, platoon unblocked						
vC, conflicting volume			299	1576	394	
vC1, stage 1 conf vol						
vC2, stage 2 conf vol						
vCu, unblocked vol			299	1576	394	
tC, single (s)			4.1	6.4	6.2	
tC, 2 stage (s)						
tF (s)			2.2	3.5	3.3	
p0 queue free %			67	100	100	
cM capacity (veh/h)			1251	80	650	
Direction, Lane #	EB 1	WB 1	WB 2			
Volume Total	490	417	348			
Volume Left	0	417	0			
Volume Right	191	0	0			
cSH	1700	1251	1700			
Volume to Capacity	0.29	0.33	0.20			
Queue Length 95th (ft)	0	37	0			
Control Delay (s)	0.0	9.3	0.0			
Lane LOS	A					
Approach Delay (s)	0.0	5.1				
Approach LOS						
Intersection Summary						
Average Delay			3.1			
Intersection Capacity Utilization			53.9%	ICU Level of Service	A	
Analysis Period (min)			15			

HCM Signalized Intersection Capacity Analysis

2: US-280 Exit Ramp & Hollywood Blvd/Montevallo Road



Movement	EBT	EBR	WBL	WBT	NBL	NBR
Lane Configurations	↑			↑	↘	↗
Traffic Volume (vph)	281	0	0	551	114	156
Future Volume (vph)	281	0	0	551	114	156
Ideal Flow (vphpl)	1900	1900	1900	1900	1900	1900
Total Lost time (s)	4.5			4.5	4.5	4.5
Lane Util. Factor	1.00			1.00	1.00	1.00
Frt	1.00			1.00	1.00	0.85
Flt Protected	1.00			1.00	0.95	1.00
Satd. Flow (prot)	1827			1827	1736	1553
Flt Permitted	1.00			1.00	0.95	1.00
Satd. Flow (perm)	1827			1827	1736	1553
Peak-hour factor, PHF	0.91	0.91	0.92	0.92	0.90	0.90
Adj. Flow (vph)	309	0	0	599	127	173
RTOR Reduction (vph)	0	0	0	0	0	142
Lane Group Flow (vph)	309	0	0	599	127	31
Turn Type	NA			NA	Prot	Perm
Protected Phases	2			2	4	
Permitted Phases						4
Actuated Green, G (s)	23.7			23.7	7.0	7.0
Effective Green, g (s)	23.7			23.7	7.0	7.0
Actuated g/C Ratio	0.60			0.60	0.18	0.18
Clearance Time (s)	4.5			4.5	4.5	4.5
Vehicle Extension (s)	3.0			3.0	3.0	3.0
Lane Grp Cap (vph)	1090			1090	306	273
v/s Ratio Prot	0.17			c0.33	c0.07	
v/s Ratio Perm						0.02
v/c Ratio	0.28			0.55	0.42	0.11
Uniform Delay, d1	3.9			4.8	14.5	13.7
Progression Factor	1.00			1.00	1.00	1.00
Incremental Delay, d2	0.1			0.6	0.9	0.2
Delay (s)	4.0			5.4	15.4	13.9
Level of Service	A			A	B	B
Approach Delay (s)	4.0			5.4	14.6	
Approach LOS	A			A	B	

Intersection Summary

HCM 2000 Control Delay	7.3	HCM 2000 Level of Service	A
HCM 2000 Volume to Capacity ratio	0.52		
Actuated Cycle Length (s)	39.7	Sum of lost time (s)	9.0
Intersection Capacity Utilization	53.9%	ICU Level of Service	A
Analysis Period (min)	15		

c Critical Lane Group

3: Montevallo Road & Brookhill

03/31/2022

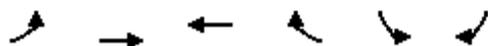

Movement	EBL	EBT	WBT	WBR	SBL	SBR
Lane Configurations	↖	↑	↗		↘	↘
Traffic Volume (veh/h)	8	424	577	5	7	13
Future Volume (Veh/h)	8	424	577	5	7	13
Sign Control		Free	Free		Stop	
Grade		0%	0%		0%	
Peak Hour Factor	0.87	0.87	0.89	0.89	0.63	0.63
Hourly flow rate (vph)	9	487	648	6	11	21
Pedestrians						
Lane Width (ft)						
Walking Speed (ft/s)						
Percent Blockage						
Right turn flare (veh)						
Median type		None	None			
Median storage (veh)						
Upstream signal (ft)		1280	801			
pX, platoon unblocked	0.97				0.97	0.97
vC, conflicting volume	654				1156	651
vC1, stage 1 conf vol						
vC2, stage 2 conf vol						
vCu, unblocked vol	625				1144	621
tC, single (s)	4.1				6.4	6.2
tC, 2 stage (s)						
tF (s)	2.2				3.5	3.3
p0 queue free %	99				95	96
cM capacity (veh/h)	915				210	467

Direction, Lane #	EB 1	EB 2	WB 1	SB 1
Volume Total	9	487	654	32
Volume Left	9	0	0	11
Volume Right	0	0	6	21
cSH	915	1700	1700	328
Volume to Capacity	0.01	0.29	0.38	0.10
Queue Length 95th (ft)	1	0	0	8
Control Delay (s)	9.0	0.0	0.0	17.1
Lane LOS	A			C
Approach Delay (s)	0.2		0.0	17.1
Approach LOS				C

Intersection Summary			
Average Delay		0.5	
Intersection Capacity Utilization		40.7%	ICU Level of Service A
Analysis Period (min)		15	

HCM Signalized Intersection Capacity Analysis

4: Cahaba Road & Montevallo Road



Movement	EBL	EBT	EBR	WBL	WBT	WBR	NBL	NBT	NBR	SBL	SBT	SBR
Lane Configurations												
Traffic Volume (vph)	103	320	41	49	235	1	60	238	113	23	223	220
Future Volume (vph)	103	320	41	49	235	1	60	238	113	23	223	220
Ideal Flow (vphpl)	1900	1900	1900	1900	1900	1900	1900	1900	1900	1900	1900	1900
Total Lost time (s)	4.5	4.5		4.5	4.5		4.5	4.5		4.5	4.5	
Lane Util. Factor	1.00	1.00		1.00	1.00		1.00	1.00		1.00	1.00	
Frt	1.00	0.98		1.00	1.00		1.00	0.95		1.00	0.93	
Flt Protected	0.95	1.00		0.95	1.00		0.95	1.00		0.95	1.00	
Satd. Flow (prot)	1736	1796		1736	1826		1736	1738		1736	1691	
Flt Permitted	0.56	1.00		0.41	1.00		0.35	1.00		0.46	1.00	
Satd. Flow (perm)	1025	1796		757	1826		645	1738		840	1691	
Peak-hour factor, PHF	0.93	0.93	0.93	0.87	0.87	0.87	0.90	0.90	0.90	0.89	0.89	0.89
Adj. Flow (vph)	111	344	44	56	270	1	67	264	126	26	251	247
RTOR Reduction (vph)	0	6	0	0	0	0	0	25	0	0	52	0
Lane Group Flow (vph)	111	382	0	56	271	0	67	365	0	26	446	0
Turn Type	Perm	NA		Perm	NA		Perm	NA		Perm	NA	
Protected Phases		4			4			2			2	
Permitted Phases	4			4			2			2		
Actuated Green, G (s)	17.9	17.9		17.9	17.9		21.8	21.8		21.8	21.8	
Effective Green, g (s)	17.9	17.9		17.9	17.9		21.8	21.8		21.8	21.8	
Actuated g/C Ratio	0.37	0.37		0.37	0.37		0.45	0.45		0.45	0.45	
Clearance Time (s)	4.5	4.5		4.5	4.5		4.5	4.5		4.5	4.5	
Vehicle Extension (s)	3.0	3.0		3.0	3.0		3.0	3.0		3.0	3.0	
Lane Grp Cap (vph)	376	660		278	671		288	777		376	756	
v/s Ratio Prot		c0.21			0.15			0.21			c0.26	
v/s Ratio Perm	0.11			0.07			0.10			0.03		
v/c Ratio	0.30	0.58		0.20	0.40		0.23	0.47		0.07	0.59	
Uniform Delay, d1	10.9	12.4		10.5	11.4		8.3	9.4		7.7	10.1	
Progression Factor	1.00	1.00		1.00	1.00		1.00	1.00		1.00	1.00	
Incremental Delay, d2	0.4	1.2		0.4	0.4		0.4	0.4		0.1	1.2	
Delay (s)	11.4	13.6		10.9	11.8		8.7	9.9		7.7	11.3	
Level of Service	B	B		B	B		A	A		A	B	
Approach Delay (s)		13.1			11.7			9.7			11.2	
Approach LOS		B			B			A			B	

Intersection Summary

HCM 2000 Control Delay	11.4	HCM 2000 Level of Service	B
HCM 2000 Volume to Capacity ratio	0.58		
Actuated Cycle Length (s)	48.7	Sum of lost time (s)	9.0
Intersection Capacity Utilization	67.9%	ICU Level of Service	C
Analysis Period (min)	15		

c Critical Lane Group

HCM Unsignalized Intersection Capacity Analysis

5: Cahaba Road & Chester Road



Movement	EBL	EBR	NBL	NBT	SBT	SBR
Lane Configurations						
Traffic Volume (veh/h)	3	3	5	363	334	3
Future Volume (Veh/h)	3	3	5	363	334	3
Sign Control	Stop			Free	Free	
Grade	0%			0%	0%	
Peak Hour Factor	0.75	0.75	0.87	0.87	0.89	0.89
Hourly flow rate (vph)	4	4	6	417	375	3
Pedestrians						
Lane Width (ft)						
Walking Speed (ft/s)						
Percent Blockage						
Right turn flare (veh)						
Median type				None	None	
Median storage (veh)						
Upstream signal (ft)					605	
pX, platoon unblocked						
vC, conflicting volume	806	376	378			
vC1, stage 1 conf vol						
vC2, stage 2 conf vol						
vCu, unblocked vol	806	376	378			
tC, single (s)	6.4	6.2	4.1			
tC, 2 stage (s)						
tF (s)	3.5	3.3	2.2			
p0 queue free %	99	99	99			
cM capacity (veh/h)	347	666	1170			
Direction, Lane #	EB 1	NB 1	NB 2	SB 1		
Volume Total	8	6	417	378		
Volume Left	4	6	0	0		
Volume Right	4	0	0	3		
cSH	456	1170	1700	1700		
Volume to Capacity	0.02	0.01	0.25	0.22		
Queue Length 95th (ft)	1	0	0	0		
Control Delay (s)	13.0	8.1	0.0	0.0		
Lane LOS	B	A				
Approach Delay (s)	13.0	0.1		0.0		
Approach LOS	B					
Intersection Summary						
Average Delay			0.2			
Intersection Capacity Utilization			29.1%		ICU Level of Service	A
Analysis Period (min)			15			

Appendix F

**Future 2025 Intersection Capacity Analysis
Worksheets**

HCM Unsignalized Intersection Capacity Analysis

1: US-280 Entrance Ramp & Hollywood Blvd

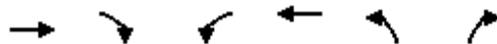

Movement	EBT	EBR	WBL	WBT	NBL	NBR
Lane Configurations	↻		↻	↻		
Traffic Volume (veh/h)	191	156	452	220	0	0
Future Volume (Veh/h)	191	156	452	220	0	0
Sign Control	Free			Free	Stop	
Grade	0%			0%	0%	
Peak Hour Factor	0.82	0.82	0.91	0.91	0.92	0.92
Hourly flow rate (vph)	233	190	497	242	0	0
Pedestrians						
Lane Width (ft)						
Walking Speed (ft/s)						
Percent Blockage						
Right turn flare (veh)						
Median type	None		None			
Median storage (veh)						
Upstream signal (ft)	260					
pX, platoon unblocked						
vC, conflicting volume			233		1564	328
vC1, stage 1 conf vol						
vC2, stage 2 conf vol						
vCu, unblocked vol			233		1564	328
tC, single (s)			4.1		6.4	6.2
tC, 2 stage (s)						
tF (s)			2.2		3.5	3.3
p0 queue free %			62		100	100
cM capacity (veh/h)			1323		76	709
Direction, Lane #	EB 1	WB 1	WB 2			
Volume Total	423	497	242			
Volume Left	0	497	0			
Volume Right	190	0	0			
cSH	1700	1323	1700			
Volume to Capacity	0.25	0.38	0.14			
Queue Length 95th (ft)	0	44	0			
Control Delay (s)	0.0	9.3	0.0			
Lane LOS	A					
Approach Delay (s)	0.0	6.3				
Approach LOS						
Intersection Summary						
Average Delay			4.0			
Intersection Capacity Utilization			51.3%	ICU Level of Service	A	
Analysis Period (min)			15			

HCM Signalized Intersection Capacity Analysis

2: US-280 Exit Ramp & Hollywood Blvd/Montevallo Road

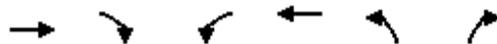

Movement	EBT	EBR	WBL	WBT	NBL	NBR
Lane Configurations	↑			↑	↘	↗
Traffic Volume (vph)	187	0	0	612	91	138
Future Volume (vph)	187	0	0	612	91	138
Ideal Flow (vphpl)	1900	1900	1900	1900	1900	1900
Total Lost time (s)	4.5			4.5	4.5	4.5
Lane Util. Factor	1.00			1.00	1.00	1.00
Frt	1.00			1.00	1.00	0.85
Flt Protected	1.00			1.00	0.95	1.00
Satd. Flow (prot)	1827			1827	1736	1553
Flt Permitted	1.00			1.00	0.95	1.00
Satd. Flow (perm)	1827			1827	1736	1553
Peak-hour factor, PHF	0.88	0.88	0.90	0.90	0.95	0.95
Adj. Flow (vph)	212	0	0	680	96	145
RTOR Reduction (vph)	0	0	0	0	0	122
Lane Group Flow (vph)	213	0	0	680	96	23
Turn Type	NA			NA	Prot	Perm
Protected Phases	2			2	4	
Permitted Phases						4
Actuated Green, G (s)	25.6			25.6	6.4	6.4
Effective Green, g (s)	25.6			25.6	6.4	6.4
Actuated g/C Ratio	0.62			0.62	0.16	0.16
Clearance Time (s)	4.5			4.5	4.5	4.5
Vehicle Extension (s)	3.0			3.0	3.0	3.0
Lane Grp Cap (vph)	1140			1140	270	242
v/s Ratio Prot	0.12			c0.37	c0.06	
v/s Ratio Perm						0.01
v/c Ratio	0.19			0.60	0.36	0.09
Uniform Delay, d1	3.3			4.6	15.5	14.8
Progression Factor	1.00			1.00	1.00	1.00
Incremental Delay, d2	0.1			0.8	0.8	0.2
Delay (s)	3.4			5.5	16.3	15.0
Level of Service	A			A	B	B
Approach Delay (s)	3.4			5.5	15.5	
Approach LOS	A			A	B	

Intersection Summary			
HCM 2000 Control Delay	7.2	HCM 2000 Level of Service	A
HCM 2000 Volume to Capacity ratio	0.55		
Actuated Cycle Length (s)	41.0	Sum of lost time (s)	9.0
Intersection Capacity Utilization	51.3%	ICU Level of Service	A
Analysis Period (min)	15		

c Critical Lane Group

HCM Unsignalized Intersection Capacity Analysis

3: Montevallo Road & Brookhill

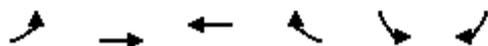

Movement	EBL	EBT	WBT	WBR	SBL	SBR
Lane Configurations						
Traffic Volume (veh/h)	2	315	600	3	5	5
Future Volume (Veh/h)	2	315	600	3	5	5
Sign Control		Free	Free		Stop	
Grade		0%	0%		0%	
Peak Hour Factor	0.91	0.91	0.86	0.86	0.50	0.50
Hourly flow rate (vph)	2	346	698	3	10	10
Pedestrians						
Lane Width (ft)						
Walking Speed (ft/s)						
Percent Blockage						
Right turn flare (veh)						
Median type		None	None			
Median storage (veh)						
Upstream signal (ft)		1280	801			
pX, platoon unblocked	0.93				0.93	0.93
vC, conflicting volume	701				1050	700
vC1, stage 1 conf vol						
vC2, stage 2 conf vol						
vCu, unblocked vol	637				1013	635
tC, single (s)	4.1				6.4	6.2
tC, 2 stage (s)						
tF (s)	2.2				3.5	3.3
p0 queue free %	100				96	98
cM capacity (veh/h)	867				242	439

Direction, Lane #	EB 1	EB 2	WB 1	SB 1
Volume Total	2	346	701	20
Volume Left	2	0	0	10
Volume Right	0	0	3	10
cSH	867	1700	1700	312
Volume to Capacity	0.00	0.20	0.41	0.06
Queue Length 95th (ft)	0	0	0	5
Control Delay (s)	9.2	0.0	0.0	17.3
Lane LOS	A			C
Approach Delay (s)	0.1		0.0	17.3
Approach LOS				C

Intersection Summary			
Average Delay		0.3	
Intersection Capacity Utilization		41.8%	ICU Level of Service
Analysis Period (min)		15	A

HCM Signalized Intersection Capacity Analysis

4: Cahaba Road & Montevallo Road



Movement	EBL	EBT	EBR	WBL	WBT	WBR	NBL	NBT	NBR	SBL	SBT	SBR
Lane Configurations												
Traffic Volume (vph)	77	174	38	49	286	1	61	161	50	10	231	221
Future Volume (vph)	77	174	38	49	286	1	61	161	50	10	231	221
Ideal Flow (vphpl)	1900	1900	1900	1900	1900	1900	1900	1900	1900	1900	1900	1900
Total Lost time (s)	4.5	4.5		4.5	4.5		4.5	4.5		4.5	4.5	
Lane Util. Factor	1.00	1.00		1.00	1.00		1.00	1.00		1.00	1.00	
Frt	1.00	0.97		1.00	1.00		1.00	0.96		1.00	0.93	
Flt Protected	0.95	1.00		0.95	1.00		0.95	1.00		0.95	1.00	
Satd. Flow (prot)	1736	1778		1736	1826		1736	1762		1736	1693	
Flt Permitted	0.49	1.00		0.60	1.00		0.37	1.00		0.61	1.00	
Satd. Flow (perm)	903	1778		1090	1826		677	1762		1114	1693	
Peak-hour factor, PHF	0.83	0.83	0.83	0.86	0.86	0.86	0.88	0.88	0.88	0.94	0.94	0.94
Adj. Flow (vph)	93	210	46	57	333	1	69	183	57	11	246	235
RTOR Reduction (vph)	0	11	0	0	0	0	0	18	0	0	53	0
Lane Group Flow (vph)	93	245	0	57	334	0	69	222	0	11	428	0
Turn Type	Perm	NA		Perm	NA		Perm	NA		Perm	NA	
Protected Phases		4			4			2			2	
Permitted Phases	4			4			2			2		
Actuated Green, G (s)	15.8	15.8		15.8	15.8		18.8	18.8		18.8	18.8	
Effective Green, g (s)	15.8	15.8		15.8	15.8		18.8	18.8		18.8	18.8	
Actuated g/C Ratio	0.36	0.36		0.36	0.36		0.43	0.43		0.43	0.43	
Clearance Time (s)	4.5	4.5		4.5	4.5		4.5	4.5		4.5	4.5	
Vehicle Extension (s)	3.0	3.0		3.0	3.0		3.0	3.0		3.0	3.0	
Lane Grp Cap (vph)	327	644		395	661		291	759		480	730	
v/s Ratio Prot		0.14			c0.18			0.13			c0.25	
v/s Ratio Perm	0.10			0.05			0.10			0.01		
v/c Ratio	0.28	0.38		0.14	0.51		0.24	0.29		0.02	0.59	
Uniform Delay, d1	9.9	10.3		9.4	10.8		7.9	8.1		7.1	9.4	
Progression Factor	1.00	1.00		1.00	1.00		1.00	1.00		1.00	1.00	
Incremental Delay, d2	0.5	0.4		0.2	0.6		0.4	0.2		0.0	1.2	
Delay (s)	10.4	10.7		9.5	11.5		8.3	8.3		7.1	10.6	
Level of Service	B	B		A	B		A	A		A	B	
Approach Delay (s)		10.6			11.2			8.3			10.6	
Approach LOS		B			B			A			B	

Intersection Summary

HCM 2000 Control Delay	10.3	HCM 2000 Level of Service	B
HCM 2000 Volume to Capacity ratio	0.55		
Actuated Cycle Length (s)	43.6	Sum of lost time (s)	9.0
Intersection Capacity Utilization	64.2%	ICU Level of Service	C
Analysis Period (min)	15		

c Critical Lane Group

HCM Unsignalized Intersection Capacity Analysis

5: Cahaba Road & Chester Road



Movement	EBL	EBR	NBL	NBT	SBT	SBR
Lane Configurations						
Traffic Volume (veh/h)	10	5	3	269	329	3
Future Volume (Veh/h)	10	5	3	269	329	3
Sign Control	Stop			Free	Free	
Grade	0%			0%	0%	
Peak Hour Factor	0.46	0.46	0.81	0.81	0.98	0.98
Hourly flow rate (vph)	22	11	4	332	336	3
Pedestrians						
Lane Width (ft)						
Walking Speed (ft/s)						
Percent Blockage						
Right turn flare (veh)						
Median type				None	None	
Median storage (veh)						
Upstream signal (ft)					605	
pX, platoon unblocked						
vC, conflicting volume	678	338	339			
vC1, stage 1 conf vol						
vC2, stage 2 conf vol						
vCu, unblocked vol	678	338	339			
tC, single (s)	6.4	6.2	4.1			
tC, 2 stage (s)						
tF (s)	3.5	3.3	2.2			
p0 queue free %	95	98	100			
cM capacity (veh/h)	414	700	1209			
Direction, Lane #	EB 1	NB 1	NB 2	SB 1		
Volume Total	33	4	332	339		
Volume Left	22	4	0	0		
Volume Right	11	0	0	3		
cSH	479	1209	1700	1700		
Volume to Capacity	0.07	0.00	0.20	0.20		
Queue Length 95th (ft)	6	0	0	0		
Control Delay (s)	13.1	8.0	0.0	0.0		
Lane LOS	B	A				
Approach Delay (s)	13.1	0.1		0.0		
Approach LOS	B					
Intersection Summary						
Average Delay			0.7			
Intersection Capacity Utilization			27.5%	ICU Level of Service	A	
Analysis Period (min)			15			

HCM Unsignalized Intersection Capacity Analysis

6: Single Family & Montevallo Road



Movement	EBT	EBR	WBL	WBT	NBL	NBR
Lane Configurations	→			←	←	↘
Traffic Volume (veh/h)	187	1	1	609	2	2
Future Volume (Veh/h)	187	1	1	609	2	2
Sign Control	Free			Free	Stop	
Grade	0%			0%	0%	
Peak Hour Factor	0.91	0.91	0.86	0.86	0.50	0.50
Hourly flow rate (vph)	205	1	1	708	4	4
Pedestrians						
Lane Width (ft)						
Walking Speed (ft/s)						
Percent Blockage						
Right turn flare (veh)						
Median type	None			None		
Median storage (veh)						
Upstream signal (ft)	320					
pX, platoon unblocked						
vC, conflicting volume			206		916	206
vC1, stage 1 conf vol						
vC2, stage 2 conf vol						
vCu, unblocked vol			206		916	206
tC, single (s)			4.1		6.4	6.2
tC, 2 stage (s)						
tF (s)			2.2		3.5	3.3
p0 queue free %			100		99	100
cM capacity (veh/h)			1353		300	830
Direction, Lane #	EB 1	WB 1	NB 1			
Volume Total	206	709	8			
Volume Left	0	1	4			
Volume Right	1	0	4			
cSH	1700	1353	441			
Volume to Capacity	0.12	0.00	0.02			
Queue Length 95th (ft)	0	0	1			
Control Delay (s)	0.0	0.0	13.3			
Lane LOS		A	B			
Approach Delay (s)	0.0	0.0	13.3			
Approach LOS			B			
Intersection Summary						
Average Delay			0.1			
Intersection Capacity Utilization			42.8%	ICU Level of Service	A	
Analysis Period (min)			15			

HCM Unsignalized Intersection Capacity Analysis

7: Condo Access & Montevallo Road



Movement	EBT	EBR	WBL	WBT	NBL	NBR
Lane Configurations	→			←	←	↘
Traffic Volume (veh/h)	189	1	1	608	4	6
Future Volume (Veh/h)	189	1	1	608	4	6
Sign Control	Free			Free	Stop	
Grade	0%			0%	0%	
Peak Hour Factor	0.91	0.91	0.86	0.86	0.50	0.50
Hourly flow rate (vph)	208	1	1	707	8	12
Pedestrians						
Lane Width (ft)						
Walking Speed (ft/s)						
Percent Blockage						
Right turn flare (veh)						
Median type	None			None		
Median storage (veh)						
Upstream signal (ft)	782			1299		
pX, platoon unblocked						
vC, conflicting volume			209	918		208
vC1, stage 1 conf vol						
vC2, stage 2 conf vol						
vCu, unblocked vol			209	918		208
tC, single (s)			4.1	6.4		6.2
tC, 2 stage (s)						
tF (s)			2.2	3.5		3.3
p0 queue free %			100	97		99
cM capacity (veh/h)			1350	299		827
Direction, Lane #	EB 1	WB 1	NB 1			
Volume Total	209	708	20			
Volume Left	0	1	8			
Volume Right	1	0	12			
cSH	1700	1350	485			
Volume to Capacity	0.12	0.00	0.04			
Queue Length 95th (ft)	0	0	3			
Control Delay (s)	0.0	0.0	12.7			
Lane LOS			A	B		
Approach Delay (s)	0.0	0.0	12.7			
Approach LOS			B			
Intersection Summary						
Average Delay			0.3			
Intersection Capacity Utilization			42.8%	ICU Level of Service	A	
Analysis Period (min)			15			

HCM Unsignalized Intersection Capacity Analysis

1: US-280 Entrance Ramp & Hollywood Blvd

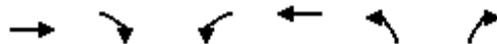

Movement	EBT	EBR	WBL	WBT	NBL	NBR
Lane Configurations	↻		↻	↻		
Traffic Volume (veh/h)	287	181	387	321	0	0
Future Volume (Veh/h)	287	181	387	321	0	0
Sign Control	Free			Free	Stop	
Grade	0%			0%	0%	
Peak Hour Factor	0.95	0.95	0.92	0.92	0.92	0.92
Hourly flow rate (vph)	302	191	421	349	0	0
Pedestrians						
Lane Width (ft)						
Walking Speed (ft/s)						
Percent Blockage						
Right turn flare (veh)						
Median type	None		None			
Median storage (veh)						
Upstream signal (ft)	260					
pX, platoon unblocked						
vC, conflicting volume			302	1588	398	
vC1, stage 1 conf vol						
vC2, stage 2 conf vol						
vCu, unblocked vol			302	1588	398	
tC, single (s)			4.1	6.4	6.2	
tC, 2 stage (s)						
tF (s)			2.2	3.5	3.3	
p0 queue free %			66	100	100	
cM capacity (veh/h)			1248	78	648	
Direction, Lane #	EB 1	WB 1	WB 2			
Volume Total	493	421	349			
Volume Left	0	421	0			
Volume Right	191	0	0			
cSH	1700	1248	1700			
Volume to Capacity	0.29	0.34	0.21			
Queue Length 95th (ft)	0	38	0			
Control Delay (s)	0.0	9.3	0.0			
Lane LOS	A					
Approach Delay (s)	0.0	5.1				
Approach LOS						
Intersection Summary						
Average Delay			3.1			
Intersection Capacity Utilization			54.3%	ICU Level of Service	A	
Analysis Period (min)			15			

HCM Signalized Intersection Capacity Analysis

2: US-280 Exit Ramp & Hollywood Blvd/Montevallo Road

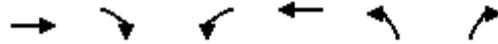

Movement	EBT	EBR	WBL	WBT	NBL	NBR
Lane Configurations	↑			↑	↘	↗
Traffic Volume (vph)	284	0	0	556	114	161
Future Volume (vph)	284	0	0	556	114	161
Ideal Flow (vphpl)	1900	1900	1900	1900	1900	1900
Total Lost time (s)	4.5			4.5	4.5	4.5
Lane Util. Factor	1.00			1.00	1.00	1.00
Frt	1.00			1.00	1.00	0.85
Flt Protected	1.00			1.00	0.95	1.00
Satd. Flow (prot)	1827			1827	1736	1553
Flt Permitted	1.00			1.00	0.95	1.00
Satd. Flow (perm)	1827			1827	1736	1553
Peak-hour factor, PHF	0.91	0.91	0.92	0.92	0.90	0.90
Adj. Flow (vph)	312	0	0	604	127	179
RTOR Reduction (vph)	0	0	0	0	0	147
Lane Group Flow (vph)	312	0	0	604	127	32
Turn Type	NA			NA	Prot	Perm
Protected Phases	2			2	4	
Permitted Phases						4
Actuated Green, G (s)	24.0			24.0	7.1	7.1
Effective Green, g (s)	24.0			24.0	7.1	7.1
Actuated g/C Ratio	0.60			0.60	0.18	0.18
Clearance Time (s)	4.5			4.5	4.5	4.5
Vehicle Extension (s)	3.0			3.0	3.0	3.0
Lane Grp Cap (vph)	1093			1093	307	274
v/s Ratio Prot	0.17			c0.33	c0.07	
v/s Ratio Perm						0.02
v/c Ratio	0.29			0.55	0.41	0.12
Uniform Delay, d1	3.9			4.8	14.7	13.9
Progression Factor	1.00			1.00	1.00	1.00
Incremental Delay, d2	0.1			0.6	0.9	0.2
Delay (s)	4.0			5.4	15.6	14.1
Level of Service	A			A	B	B
Approach Delay (s)	4.0			5.4	14.7	
Approach LOS	A			A	B	

Intersection Summary

HCM 2000 Control Delay	7.4	HCM 2000 Level of Service	A
HCM 2000 Volume to Capacity ratio	0.52		
Actuated Cycle Length (s)	40.1	Sum of lost time (s)	9.0
Intersection Capacity Utilization	54.3%	ICU Level of Service	A
Analysis Period (min)	15		

c Critical Lane Group

3: Montevallo Road & Brookhill

06/10/2022

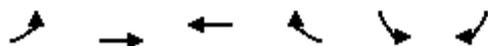

Movement	EBL	EBT	WBT	WBR	SBL	SBR
Lane Configurations						
Traffic Volume (veh/h)	8	431	584	5	7	13
Future Volume (Veh/h)	8	431	584	5	7	13
Sign Control		Free	Free		Stop	
Grade		0%	0%		0%	
Peak Hour Factor	0.87	0.87	0.89	0.89	0.63	0.63
Hourly flow rate (vph)	9	495	656	6	11	21
Pedestrians						
Lane Width (ft)						
Walking Speed (ft/s)						
Percent Blockage						
Right turn flare (veh)						
Median type		None	None			
Median storage (veh)						
Upstream signal (ft)		1280	801			
pX, platoon unblocked	0.96				0.96	0.96
vC, conflicting volume	662				1172	659
vC1, stage 1 conf vol						
vC2, stage 2 conf vol						
vCu, unblocked vol	628				1159	625
tC, single (s)	4.1				6.4	6.2
tC, 2 stage (s)						
tF (s)	2.2				3.5	3.3
p0 queue free %	99				95	95
cM capacity (veh/h)	908				204	462

Direction, Lane #	EB 1	EB 2	WB 1	SB 1
Volume Total	9	495	662	32
Volume Left	9	0	0	11
Volume Right	0	0	6	21
cSH	908	1700	1700	322
Volume to Capacity	0.01	0.29	0.39	0.10
Queue Length 95th (ft)	1	0	0	8
Control Delay (s)	9.0	0.0	0.0	17.4
Lane LOS	A			C
Approach Delay (s)	0.2		0.0	17.4
Approach LOS				C

Intersection Summary			
Average Delay		0.5	
Intersection Capacity Utilization		41.0%	ICU Level of Service
Analysis Period (min)		15	A

HCM Signalized Intersection Capacity Analysis

4: Cahaba Road & Montevallo Road



Movement	EBL	EBT	EBR	WBL	WBT	WBR	NBL	NBT	NBR	SBL	SBT	SBR
Lane Configurations												
Traffic Volume (vph)	104	322	44	50	239	1	63	238	113	23	224	223
Future Volume (vph)	104	322	44	50	239	1	63	238	113	23	224	223
Ideal Flow (vphpl)	1900	1900	1900	1900	1900	1900	1900	1900	1900	1900	1900	1900
Total Lost time (s)	4.5	4.5		4.5	4.5		4.5	4.5		4.5	4.5	
Lane Util. Factor	1.00	1.00		1.00	1.00		1.00	1.00		1.00	1.00	
Frt	1.00	0.98		1.00	1.00		1.00	0.95		1.00	0.93	
Flt Protected	0.95	1.00		0.95	1.00		0.95	1.00		0.95	1.00	
Satd. Flow (prot)	1736	1794		1736	1826		1736	1738		1736	1690	
Flt Permitted	0.55	1.00		0.41	1.00		0.35	1.00		0.46	1.00	
Satd. Flow (perm)	1012	1794		748	1826		633	1738		836	1690	
Peak-hour factor, PHF	0.93	0.93	0.93	0.87	0.87	0.87	0.90	0.90	0.90	0.89	0.89	0.89
Adj. Flow (vph)	112	346	47	57	275	1	70	264	126	26	252	251
RTOR Reduction (vph)	0	7	0	0	0	0	0	25	0	0	53	0
Lane Group Flow (vph)	112	386	0	57	276	0	70	365	0	26	450	0
Turn Type	Perm	NA		Perm	NA		Perm	NA		Perm	NA	
Protected Phases		4			4			2			2	
Permitted Phases	4			4			2			2		
Actuated Green, G (s)	18.3	18.3		18.3	18.3		22.0	22.0		22.0	22.0	
Effective Green, g (s)	18.3	18.3		18.3	18.3		22.0	22.0		22.0	22.0	
Actuated g/C Ratio	0.37	0.37		0.37	0.37		0.45	0.45		0.45	0.45	
Clearance Time (s)	4.5	4.5		4.5	4.5		4.5	4.5		4.5	4.5	
Vehicle Extension (s)	3.0	3.0		3.0	3.0		3.0	3.0		3.0	3.0	
Lane Grp Cap (vph)	375	665		277	677		282	775		373	754	
v/s Ratio Prot		c0.22			0.15			0.21			c0.27	
v/s Ratio Perm	0.11			0.08			0.11			0.03		
v/c Ratio	0.30	0.58		0.21	0.41		0.25	0.47		0.07	0.60	
Uniform Delay, d1	11.0	12.4		10.6	11.5		8.5	9.6		7.8	10.3	
Progression Factor	1.00	1.00		1.00	1.00		1.00	1.00		1.00	1.00	
Incremental Delay, d2	0.4	1.3		0.4	0.4		0.5	0.5		0.1	1.3	
Delay (s)	11.4	13.7		10.9	11.9		9.0	10.0		7.9	11.6	
Level of Service	B	B		B	B		A	B		A	B	
Approach Delay (s)		13.2			11.7			9.9			11.4	
Approach LOS		B			B			A			B	

Intersection Summary

HCM 2000 Control Delay	11.6	HCM 2000 Level of Service	B
HCM 2000 Volume to Capacity ratio	0.59		
Actuated Cycle Length (s)	49.3	Sum of lost time (s)	9.0
Intersection Capacity Utilization	68.4%	ICU Level of Service	C
Analysis Period (min)	15		

c Critical Lane Group

HCM Unsignalized Intersection Capacity Analysis

5: Cahaba Road & Chester Road



Movement	EBL	EBR	NBL	NBT	SBT	SBR
Lane Configurations						
Traffic Volume (veh/h)	5	4	7	366	335	6
Future Volume (Veh/h)	5	4	7	366	335	6
Sign Control	Stop			Free	Free	
Grade	0%			0%	0%	
Peak Hour Factor	0.75	0.75	0.87	0.87	0.89	0.89
Hourly flow rate (vph)	7	5	8	421	376	7
Pedestrians						
Lane Width (ft)						
Walking Speed (ft/s)						
Percent Blockage						
Right turn flare (veh)						
Median type				None	None	
Median storage (veh)						
Upstream signal (ft)					605	
pX, platoon unblocked						
vC, conflicting volume	816	380	383			
vC1, stage 1 conf vol						
vC2, stage 2 conf vol						
vCu, unblocked vol	816	380	383			
tC, single (s)	6.4	6.2	4.1			
tC, 2 stage (s)						
tF (s)	3.5	3.3	2.2			
p0 queue free %	98	99	99			
cM capacity (veh/h)	341	663	1165			
Direction, Lane #	EB 1	NB 1	NB 2	SB 1		
Volume Total	12	8	421	383		
Volume Left	7	8	0	0		
Volume Right	5	0	0	7		
cSH	428	1165	1700	1700		
Volume to Capacity	0.03	0.01	0.25	0.23		
Queue Length 95th (ft)	2	1	0	0		
Control Delay (s)	13.7	8.1	0.0	0.0		
Lane LOS	B	A				
Approach Delay (s)	13.7	0.2		0.0		
Approach LOS	B					
Intersection Summary						
Average Delay			0.3			
Intersection Capacity Utilization			29.3%		ICU Level of Service	A
Analysis Period (min)			15			

HCM Unsignalized Intersection Capacity Analysis

6: Single Family & Montevallo Road

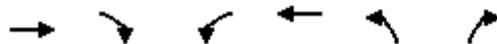

Movement	EBT	EBR	WBL	WBT	NBL	NBR
Lane Configurations	↻			↻	↻	
Traffic Volume (veh/h)	287	2	2	554	1	1
Future Volume (Veh/h)	287	2	2	554	1	1
Sign Control	Free			Free	Stop	
Grade	0%			0%	0%	
Peak Hour Factor	0.87	0.87	0.89	0.89	0.63	0.63
Hourly flow rate (vph)	330	2	2	622	2	2
Pedestrians						
Lane Width (ft)						
Walking Speed (ft/s)						
Percent Blockage						
Right turn flare (veh)						
Median type	None			None		
Median storage (veh)						
Upstream signal (ft)	380					
pX, platoon unblocked						
vC, conflicting volume			332	957		331
vC1, stage 1 conf vol						
vC2, stage 2 conf vol						
vCu, unblocked vol			332	957		331
tC, single (s)			4.1	6.4		6.2
tC, 2 stage (s)						
tF (s)			2.2	3.5		3.3
p0 queue free %			100	99		100
cM capacity (veh/h)			1216	283		706
Direction, Lane #	EB 1	WB 1	NB 1			
Volume Total	332	624	4			
Volume Left	0	2	2			
Volume Right	2	0	2			
cSH	1700	1216	404			
Volume to Capacity	0.20	0.00	0.01			
Queue Length 95th (ft)	0	0	1			
Control Delay (s)	0.0	0.0	14.0			
Lane LOS	A		B			
Approach Delay (s)	0.0	0.0	14.0			
Approach LOS			B			
Intersection Summary						
Average Delay			0.1			
Intersection Capacity Utilization			40.7%	ICU Level of Service		A
Analysis Period (min)	15					

HCM Unsignalized Intersection Capacity Analysis

7: Condo Access & Montevallo Road

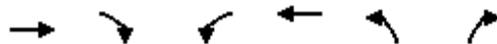

Movement	EBT	EBR	WBL	WBT	NBL	NBR
Lane Configurations	→			←	←	↘
Traffic Volume (veh/h)	284	4	6	554	2	4
Future Volume (Veh/h)	284	4	6	554	2	4
Sign Control	Free			Free	Stop	
Grade	0%			0%	0%	
Peak Hour Factor	0.87	0.87	0.89	0.89	0.63	0.63
Hourly flow rate (vph)	326	5	7	622	3	6
Pedestrians						
Lane Width (ft)						
Walking Speed (ft/s)						
Percent Blockage						
Right turn flare (veh)						
Median type	None			None		
Median storage (veh)						
Upstream signal (ft)	900			1181		
pX, platoon unblocked						
vC, conflicting volume			331	964		328
vC1, stage 1 conf vol						
vC2, stage 2 conf vol						
vCu, unblocked vol			331	964		328
tC, single (s)			4.1	6.4		6.2
tC, 2 stage (s)						
tF (s)			2.2	3.5		3.3
p0 queue free %			99	99		99
cM capacity (veh/h)			1217	279		708
Direction, Lane #	EB 1	WB 1	NB 1			
Volume Total	331	629	9			
Volume Left	0	7	3			
Volume Right	5	0	6			
cSH	1700	1217	468			
Volume to Capacity	0.19	0.01	0.02			
Queue Length 95th (ft)	0	0	1			
Control Delay (s)	0.0	0.2	12.8			
Lane LOS			A	B		
Approach Delay (s)	0.0	0.2	12.8			
Approach LOS			B			
Intersection Summary						
Average Delay			0.2			
Intersection Capacity Utilization			43.9%	ICU Level of Service	A	
Analysis Period (min)			15			

APPENDIX E
SUBDIVISION COVENANTS

Declaration Of Covenants, Easements, Conditions, And Restrictions
of
[XYZ] Subdivision
_____ , 2022

THIS INSTRUMENT PREPARED BY:
Melinda E. Sellers
Burr & Forman LLP
420 North 20th Street, Suite 3400
Birmingham, AL 35203
(205) 251-3000

TABLE OF CONTENTS**TABLE OF CONTENTS**

	<u>Page</u>
ARTICLE I DEFINITIONS	7
Section 1.1 Additional Property.....	7
Section 1.2 Annual Assessments.	7
Section 1.3 ARC.	7
Section 1.4 Architectural Standards.....	7
Section 1.5 Assessment.....	8
Section 1.6 Association.....	8
Section 1.7 Board.....	8
Section 1.8 Bylaws.....	8
Section 1.9 Certificate of Formation.....	8
Section 1.10 Common Areas.	8
Section 1.11 Common Expenses.....	9
Section 1.12 Declaration.....	9
Section 1.13 Developer.....	9
Section 1.14 Developer Control Period.	9
Section 1.15 Governmental Authority.	9
Section 1.16 Improvement.	9
Section 1.17 Individual Assessment.	9
Section 1.18 Lot.....	9
Section 1.19 Member.....	10
Section 1.20 Mortgage.....	10
Section 1.21 Mortgagee.....	10
Section 1.22 Occupant.....	10
Section 1.23 Owner.....	10
Section 1.24 Probate Office.....	10
Section 1.25 Property.....	10
Section 1.26 Rules and Regulations.....	10
Section 1.27 Single Family Unit.....	10
Section 1.28 Special Assessments.....	10
Section 1.29 Subdivision.....	10

Section 1.30	Subdivision Record Map.....	11
ARTICLE II RESTRICTIONS APPLICABLE TO THE PROPERTY.....		11
Section 2.1	General Declaration.	11
Section 2.2	Additional Property.....	11
Section 2.3	Right of Developer to Modify Restrictions with Respect to Lots Owned by Developer.	11
Section 2.4	Mutuality of Benefit and Obligation.....	12
Section 2.5	Development of Property.....	12
Section 2.6	Subdivision Record Map.....	12
Section 2.7	Parking.....	13
ARTICLE III ORGANIZATION AND MANAGEMENT OF THE ASSOCIATION.....		13
Section 3.1	Members.	13
Section 3.2	Association Insurance Requirements.....	13
ARTICLE IV EASEMENTS.....		13
Section 4.1	Grant of Nonexclusive Easements to Owners: Subject to the terms and conditions of this Declaration and the Rules and Regulations from time to time established by the Association with respect to the Common Areas and Easement for Ingress and Egress, Developer does hereby grant to each Owner and Occupant the nonexclusive right, privilege, and easement of access to and the use and enjoyment of the Common Areas and for purposes of ingress and egress to the Lots, an easement for ingress and egress as shown on the Subdivision Record Map (“Easement for Ingress and Egress”) in common with all other Owners and Occupants and their parties having a right or interest therein and their respective successors and/or assigns.....	13
Section 4.2	Utility Easements.....	14
Section 4.3	Additional Easements and Uses.....	14
Section 4.4	Reservation of General Access Easement.....	14
Section 4.5	Reservation of Easements With Respect to Common Areas.....	15
Section 4.6	Additional Documents.	15
Section 4.7	Limitations.....	15
ARTICLE V ARCHITECTURAL CONTROL.....		16
Section 5.1	Architectural Control.	16
Section 5.2	Architectural Standards.....	16
Section 5.3	Approval of Plans and Specifications.....	17
Section 5.4	Construction Without Approval.....	19
Section 5.5	Inspection.....	19
Section 5.6	Limitation of Liability.....	19
Section 5.7	Enforcement and Remedies.	20

ARTICLE VI RESTRICTIONS	20
Section 6.1 Rules and Regulations of the Association.	20
Section 6.2 Restrictions on Use.	21
Section 6.3 Landscaping.	23
Section 6.4 Storm Drains.	24
Section 6.5 Exterior Lighting.	24
Section 6.6 Exterior Materials and Finishes.	24
Section 6.7 Fences.	24
Section 6.8 Windows, Window Treatments and Doors.	24
Section 6.9 Mailboxes.	24
Section 6.10 Outdoor Furniture and Recreational Facilities.	24
Section 6.11 Trash, Rubbish and Nuisances.	25
Section 6.12 Recreational Vehicles and Machinery and Equipment.	25
Section 6.13 Signage.	26
Section 6.14 Construction of Improvements.	26
Section 6.15 Swimming Pools.	27
Section 6.16 Traffic Regulations.	27
Section 6.17 Lease of Lots.	27
Section 6.18 Right of Access.	27
Section 6.19 Limitation of Liability.	28
Section 6.20 Enforcement.	28
Section 6.21 Failure of the Association to Insist on Strict Performance; No Waiver.	28
Section 6.22 Use by Developer.	29
Section 6.23 Common Areas.	29
Section 6.24 Compliance with Governmental Regulations.	29
Section 6.25 Additional Regulations.	29
ARTICLE VII COVENANT FOR ASSESSMENTS	29
Section 7.1 Affirmative Covenant to Pay Assessments.	29
Section 7.2 Purpose of Assessments.	30
Section 7.3 Individual Assessment.	30
Section 7.4 Annual Assessments.	30
Section 7.5 Special Assessments.	30
Section 7.6 Special Meeting.	31
Section 7.7 Amount of Assessments.	31

Section 7.8	Certificate.....	31
Section 7.9	Effect of Non-Payment of Assessments; Liens; Remedies.....	31
Section 7.10	Damages.....	32
Section 7.11	Exempt Property.	33
ARTICLE VIII MAINTENANCE RESPONSIBILITIES		33
Section 8.1	Responsibilities of Owners -Maintenance.	33
Section 8.2	Responsibilities of Owners - Utilities.....	34
Section 8.3	Responsibilities of Association – Maintenance.	34
Section 8.4	Responsibilities of Association - Common Expenses.	34
Section 8.5	Reserves.	35
Section 8.6	Interested Transactions.	35
ARTICLE IX ENFORCEMENT OF PROTECTIVE COVENANTS, DEFAULTS AND REMEDIES.....		35
Section 9.1	Covenants Running with the Land.....	35
Section 9.2	Remedies for Default.	36
Section 9.3	Nature of Remedies: Waiver.....	36
Section 9.4	Attorneys’ Fees and Costs.	36
Section 9.5	No Reverter.	36
ARTICLE X AMENDMENT OF DECLARATION		36
Section 10.1	Amendment by Association.....	36
Section 10.2	Scrivener’s Error.....	37
ARTICLE XI PERIOD OF DEVELOPER CONTROL.....		37
Section 11.1	Developer Control.....	37
ARTICLE XII GENERAL PROVISIONS.....		38
Section 12.1	Deeds Subject to Covenant.	38
Section 12.2	Obligation of Owner to Build or Restore.....	38
Section 12.3	No Trespass.....	38
Section 12.4	Notices.	38
Section 12.5	Severability.	38
Section 12.6	Governing Law.	38
Section 12.7	Captions.	38
Section 12.8	Usage.....	38
Section 12.9	Conflict.	38
Section 12.10	Effective Date.	39

EXHIBITS

- Exhibit "A" Legal Description of Property
- Exhibit "B" Bylaws of [XYZ] Subdivision Association, Inc.

**DECLARATION OF COVENANTS, EASEMENTS, CONDITIONS AND
RESTRICTIONS OF [XYZ] SUBDIVISION**

THIS DECLARATION OF COVENANTS, EASEMENTS, CONDITIONS AND RESTRICTIONS FOR [XYZ] SUBDIVISION (this “Declaration”) is made as of the __ day of _____, 202__ by [_____], LLC, an Alabama limited liability company (the “Developer”).

RECITALS:

WHEREAS, Developer is the owner of certain real property situated in Jefferson County, Alabama, more particularly described on Exhibit “A” attached hereto (the “Property”). Developer intends to develop, improve, lease and sell the Property for residential uses, subject to certain easements, covenants, conditions, restrictions, requirements, and obligations, in order to protect the value and desirability of the Property and to have a flexible and reasonable method for the development, administration, and maintenance of the Property.

NOW, THEREFORE, Developer, upon the recording hereof, does hereby declare that all of the Property shall be held, developed, improved, transferred, sold, conveyed, leased, occupied and used subject to the easements, covenants, conditions, restrictions, requirements and obligations hereafter set forth as applicable to the Property, which shall be binding upon and inure to the benefit of all parties acquiring or having any right, title or interest in any portion of the Property and their respective heirs, executors, administrators, personal representatives, successors and assigns.

**ARTICLE I
DEFINITIONS**

As used in this Declaration, the following initially capitalized terms shall have the following meanings, which meanings shall be applicable to both the singular and plural forms and tenses of such terms:

Section 1.1 Additional Property. The term “Additional Property” shall mean and refer to any real property and any Improvements situated thereon lying adjacent to or in close proximity with the Property (but which does not presently comprise any part of the Property) which Developer may from time to time submit and add to the provisions of this Declaration pursuant to the provisions of Section 2.2 below. The Additional Property may also include additional Common Areas.

Section 1.2 Annual Assessments. The term “Annual Assessment” shall have the meaning ascribed to it in Section 6.4 hereof.

Section 1.3 ARC. The term “ARC” shall mean the Architectural Review Committee appointed pursuant to Article IV hereof with the rights and obligations conferred upon such Architectural Review Committee pursuant to this Declaration.

Section 1.4 Architectural Standards. The term “Architectural Standards” shall mean the standards prepared, issued and amended from time to time by the ARC pursuant to

Article IV below for the purpose of establishing policies, guidelines and minimum requirements with regard to the construction, location, landscaping, design, architectural style and any other matters relating to the construction, repair, replacement and alteration of Improvements on the Lots. The Developer shall work with the City of [_____] to develop these standards for the Lots. In addition, the term “Architectural Standards” shall include, without limitation, any additional construction and development guidelines adopted from time to time by the ARC or the Board.

Section 1.5 Assessment. The term “Assessment” shall mean the assessments to be assessed against the Owners pursuant to the authority vested in the Association, and such term shall include the Annual Assessments, Special Assessments and Individual Assessments.

Section 1.6 Association. The term “Association” shall mean [XYZ] Subdivision Association, Inc., an Alabama non-profit corporation, and its successors and assigns.

Section 1.7 Board. The term “Board” shall mean the Board of Directors of the Association and their duly elected successors as may be provided in the Certificate of Formation and Bylaws.

Section 1.8 Bylaws. The term “Bylaws” shall mean the Bylaws of the Association attached hereto as Exhibit “B”, as such Bylaws may be amended from time to time.

Section 1.9 Certificate of Formation. The term “Certificate of Formation” shall mean the Certificate of Formation of the Association, filed with the Secretary of State and having the Entity Number _____, as said Certificate may be amended from time to time.

Section 1.10 Common Areas. The term “Common Areas” shall mean and refer to all real and/or personal property, including property which the Association now or hereafter owns or otherwise acquires by lease, easement or otherwise, for the common use and enjoyment of the Owners, and which shall be the responsibility of the Association to maintain, and which shall include, without limitation, the following: (a) all signage for the Property situated on or within any entrance easement, within private roads, or rights-of-way of any public roads within the Property (but specifically excluding any signage located within the boundaries of any Lot unless an easement has been granted to (and accepted by) Developer or the Association for signage on such Lot), including, without limitation, informational, traffic and street signage; (b) any street or roadway and landscaping lighting situated within the right-of-way of any streets within any portion of the Property (to the extent the same are not being maintained by any Governmental Authority); (c) all sidewalks, paths and on-street parking spaces, if any, situated within any portion of the Property (other than such areas located within the boundary lines of any Lot or which are maintained by any Governmental Authority); (d) all gates, walls, fences, Improvements, landscaping and landscaped areas situated within the Common Areas or rights-of-way of any public roadways within the Property, (e) all water features, storm drains and sewers, drainage and/or watershed protection or retention ponds, basins or other areas and facilities located within the Property (other than such areas located within the boundary lines of any Lot or which are maintained by any Governmental Authority); (f) all utility and irrigation lines, pipes, ducts, conduits, equipment, machinery and other apparatus and appurtenances which serve any portion of the Common Areas (which are not owned or maintained by any public or private utility

providers or any Governmental Authorities), including sanitary sewer pumping stations; (g) any and all other areas designated on any Subdivision Record Map as a “Common Area”; and (h) any other areas or Improvements on or within the Property which are designated by Developer as Common Areas from time to time. The designation of any land and/or Improvements as Common Areas shall not mean or imply that the public at large acquires any easement of use or enjoyment or any other rights, licenses or benefits therein or to the use thereof.

Section 1.11 Common Expenses. The term “Common Expenses” shall mean and refer to all expenditures made or incurred by or on behalf of the Association, including, without limitation, those expenses described in Section 7.5 below, together with all funds assessed for the creation or maintenance of reserves pursuant to the provisions of this Declaration.

Section 1.12 Declaration. The term “Declaration” shall mean and refer to this Declaration of Covenants, Easements, Conditions and Restrictions for [XYZ] Subdivision, together with all amendments thereto.

Section 1.13 Developer. The term “Developer” shall mean [_____], LLC, an Alabama limited liability company, and its successors and assigns, if such successors or assigns acquire any portion of the Property and are designated as successor developer by Developer.

Section 1.14 Developer Control Period. The term “Developer Control Period” shall have the meaning ascribed to it in Section 11.1 hereof.

Section 1.15 Governmental Authority. The term “Governmental Authority” shall mean and refer to any and all city, county, state and federal governmental or quasi-governmental agencies, bureaus, departments, divisions or regulatory authorities having jurisdiction over any portion of the Property or any Improvements thereto.

Section 1.16 Improvement. The term “Improvement” shall mean and refer to any dwellings, any building, structure, planting or device constructed, erected or placed upon any Lot or Common Area which in any way affects the exterior appearance of any Lot or Common Area. Improvements shall include, by way of illustration and not limitation, buildings, sheds, foundations, covered patios, underground utilities, roads, driveways, walkways, paving, curbing, parking areas, trees, shrubbery, landscaping, fences, screening, walls, signs, and any other artificial or man-made changes or alterations to the natural condition of any Lot.

Section 1.17 Individual Assessment. The term “Individual Assessment” shall have the meaning ascribed to it in Section 6.3 hereof.

Section 1.18 Lot. The term “Lot” shall mean and refer to any portion of the Property upon which it is intended that a dwelling be constructed thereon. Upon the recordation of any Subdivision Record Map for any portion of the Property, each Lot indicated thereon (other than any Lots designated thereon as Common Areas or which subsequently become Common Areas) shall be deemed a Lot for purposes of this Declaration; provided, however, that a Lot may be unplatted and may be described by metes and bounds legal description.

Section 1.19 Member. The term “Member” shall mean any person who is a member of the Association. Every Owner shall be a Member of the Association.

Section 1.20 Mortgage. The term “Mortgage” shall mean any first mortgage encumbering a Lot or any interest therein and which shall have been duly and properly recorded in the Probate Office.

Section 1.21 Mortgagee. The term “Mortgagee” shall mean the holder of any first Mortgage.

Section 1.22 Occupant. The term “Occupant” shall mean and include any Owner, the family members, guests, tenants, agents, employees or invitees of any Owner and their respective family members, guests, tenants, agents, employees, invitees and any other person who occupies or uses any dwelling within the Subdivision. All action or omission of any Occupant is and shall be deemed the action or omission of the Owner of such dwelling.

Section 1.23 Owner. The term “Owner” shall mean and refer to the record owner, including Developer, of fee simple title to any Lot, whether a corporation, partnership, proprietorship, association or other entity of any nature, including natural persons, but shall not include (i) any Mortgagee of Lot, unless and until such Mortgagee has foreclosed on its Mortgage and purchased such Lot or dwelling at the foreclosure sale held with respect to the foreclosure of such Mortgage or accepted a deed in lieu of foreclosure or (ii) any lessee, purchaser, contract purchaser or vendor who has an interest in any Lot solely by virtue of a lease, contract, installment contract or other agreement.

Section 1.24 Probate Office. The term “Probate Office” shall mean and refer to the Office of the Judge of Probate of Jefferson County, Alabama, and any successors thereto which serves as the official public registry for the public recording of real estate documents in Jefferson County, Alabama.

Section 1.25 Property. The term “Property” shall mean and refer to the real property more particularly described on Exhibit “A” attached hereto, including all the Lots described on Exhibit “A” and all easements as reflected on the Subdivision Record Map.

Section 1.26 Rules and Regulations. The term “Rules and Regulations” shall mean those Rules and Regulations adopted from time to time by the Board of Directors that are deemed necessary for the enjoyment of the Property.

Section 1.27 Single Family Unit. The term “Single Family Unit” shall mean a group of one or more persons each related to the other by marriage or legal adoption, or a group of not more than three persons not all so related, who maintain a common household in a dwelling.

Section 1.28 Special Assessments. The term “Special Assessments” shall have the meaning ascribed to it in Section 6.5 hereof.

Section 1.29 Subdivision. The term “Subdivision” shall mean [XYZ] Subdivision as shown on the Subdivision Record Map, as may be amended from time to time.

Section 1.30 Subdivision Record Map. The term “Subdivision Record Map” shall mean each recorded map or plat for one or more phases of [XYZ] Subdivision, each as shall be recorded in the Probate Office, and any amendments or supplements thereof.

ARTICLE II RESTRICTIONS APPLICABLE TO THE PROPERTY

Section 2.1 General Declaration. Developer hereby declares that the Property is and shall be subject to the easements, covenants, conditions, restrictions, charges, liens and regulations of this Declaration and the Property, any part thereof and each Lot thereof shall be held, owned, sold, transferred, conveyed, hypothecated, encumbered, leased, occupied, built upon and otherwise used, improved and maintained subject to the terms of this Declaration, which easements, covenants, conditions, restrictions, charges, liens and regulations shall run with the title to such Property and shall be binding upon and inure to the benefit of Developer and upon all Owners and Occupants of the Property and any Lot thereof. This Declaration shall not apply to any other real property owned by Developer unless the same is subjected specifically by written instrument to this Declaration in accordance with Section 2.2 hereof.

Section 2.2 Additional Property. Developer reserves the right, in its sole and absolute discretion and without the consent of the Association, the Owners, Occupants, or Mortgagees of any Lot or dwelling, at any time and from time to time during the pendency of this Declaration, to add and submit any Additional Property to the provisions of this Declaration and, to the extent any of the Additional Property is specifically submitted to the terms and provisions of this Declaration by Developer, then any such Additional Property shall constitute part of the Property. Additional Property may be submitted to the provisions of this Declaration by an instrument executed by Developer in the manner required for the execution of deeds and recorded in the Probate Office, which instrument shall be deemed an amendment to this Declaration (which need not be consented to or approved by any Owner, Occupant or Mortgagee of any Lot) and shall (a) refer to this Declaration stating the Instrument Number in the Probate Office where this Declaration is recorded, (b) contain a statement that such Additional Property is subject to the provisions of this Declaration, (c) contain a legal description of such Additional Property and (d) state such other or different covenants, conditions and restrictions as the Developer, in its sole discretion, shall specify to regulate and control the use, occupancy and improvement of such Additional Property. In no event shall Developer be obligated to submit any Additional Property to the provisions of this Declaration or to impose any of the covenants, conditions or restrictions set forth in this Declaration upon any real property owned by Developer situated adjacent to or in close proximity with the Subdivision. Notwithstanding anything provided in this Declaration to the contrary, (1) the provisions of this Section 2.2 may not be abrogated, modified, rescinded, supplemented or amended, in whole or in part, without the prior written consent of Developer and (2) the rights reserved by Developer pursuant to this Section 2.2 shall not be deemed to inure to the benefit of any transferee or purchaser of the Additional Property or any portion thereof, unless Developer, in its sole discretion, transfers and conveys to such transferee or purchaser the rights reserved herein by express reference to Section 2.2 of this Declaration.

Section 2.3 Right of Developer to Modify Restrictions with Respect to Lots Owned by Developer. With respect to any Lot owned by Developer, Developer may, by deed, contract or other instrument filed for record in the manner specified in Section 2.2 above, modify

the provisions of this Declaration as the same apply to any such Lot, without the consent of the Association, or by any Owner, Occupant, or Mortgagee of any Lot or dwelling thereon.

Section 2.4 Mutuality of Benefit and Obligation. The provisions of this Declaration are made (a) for the mutual and reciprocal benefit of each Lot within the Property and are intended to create mutual, equitable servitudes upon and in favor of each Lot, (b) to create reciprocal rights and obligations between the respective Owners, Occupants and all future and subsequent Owners and Occupants of any Lot within the Property, and (c) to create a privity of contract and estate between the Owners and Occupants, their respective heirs, successors and assigns.

Section 2.5 Development of Property. At any time during the Developer Control Period and at any time thereafter for so long as Developer owns any portion of the Property, Developer shall have the right to make improvements and changes to all Common Areas and to all Lots owned by Developer, including, without limitation, (a) installing and maintaining any Improvements in or to the Common Areas, (b) changing the location of the boundaries of any Lots owned by Developer or the boundaries of any of the Common Areas, (c) changing the boundaries of any portion of the Property owned by Developer including any Additional Property owned by Developer, (d) installing and maintaining any water, sanitary sewer, storm sewer and any other utility systems and facilities within any of the Common Areas, (e) converting and changing any Lots or any portion thereof owned by Developer into Common Areas, streets, roadways, paths, parks or other uses and (f) removing or exempting any portion of the Property and any Lots or Common Areas from the terms and provisions of this Declaration. The exercise by Developer of any of the rights reserved unto Developer in this Section 2.5 may be exercised by Developer without any requirement that the consent or approval of any Owners, the Association, the ARC or any Mortgagees be obtained.

Section 2.6 Subdivision Record Map. Developer reserves the right to record, modify, amend, revise and otherwise add to, at any time and from time to time, the Subdivision Record Map of the Property setting forth such information as Developer may deem necessary with regard to the Property, including, without limitation, the locations and dimensions of all Lots, Common Areas, Additional Property, public or private roads, utility systems, drainage systems, utility easements, drainage easements, access easements, set-back line restrictions, retention ponds and drainage basins. Any such Subdivision Record Maps or any amendments thereto shall be binding on the portions of the Property indicated thereon as if such Subdivision Record Map were specifically incorporated into this Declaration. Notwithstanding anything provided to the contrary in this Declaration, the rights reserved by Developer pursuant to this Section 2.6 may be exercised by Developer without any requirement that the consent or approval of any Owners or Mortgagees be obtained (other than the Owner or Mortgagee of any Lot which is being subdivided or re-subdivided) and shall include, without limitation, the right to (a) divide and re-subdivide, combine, subdivide and re-subdivide any Lots, Common Areas and other portions of the Property owned by Developer, and (b) amend from time to time and at any time Exhibit "A" to this Declaration to reflect any such subdivision or re-subdivision of any portion of the Property, or the addition of Additional Property.

Section 2.7 Parking. All vehicles shall be parked within the garage located on the Lot. No vehicles may be parked on the street at any time. Guests may park in the driveway of the Lot they are visiting.

ARTICLE III ORGANIZATION AND MANAGEMENT OF THE ASSOCIATION

Section 3.1 Members. All Owners shall be members of the Association.

Section 3.2 Association Insurance Requirements. The Association shall obtain and maintain at all times the following insurance:

(a) Fidelity Bonds and Directors' and Officers' Insurance covering all directors, officers and employees of the Association and all managing agents who handle Association funds;

(b) Adequate property and casualty insurance for the benefit of the Association insuring all insurable improvements, if any, located within the Common Areas against loss or damage by fire or other hazards, including, without limitation, extended coverage, flood, vandalism and malicious mischief, which coverage shall be in an amount, with such insurance carriers, at such costs and with such deductibles as the Association may determine;

(c) Public liability insurance coverage covering all of the Common Areas and any damage or injury caused by the negligence of the Association and its directors, officers, partners, agents and employees thereof, in such amounts, with such insurance carriers, at such costs and with such deductibles as the Board may determine;

(d) If applicable, worker's compensation insurance, employer's liability insurance and all other types of insurance required by law, including, without limitation, errors and omissions insurance coverage, in such amounts, with such insurance carriers, at such costs and with such deductibles as the Association may determine; and

(e) All insurance coverage authorized hereunder shall be written in the name of the Association. To the extent the same may be obtained at a nominal cost, all such policies shall contain a waiver of subrogation clause pursuant to which the insurer waives any claims against the Association, and the Owners, Occupants and the family members, servants, agents, and guests of the Owners and/or Occupants.

ARTICLE IV EASEMENTS

Section 4.1 Grant of Nonexclusive Easements to Owners: Subject to the terms and conditions of this Declaration and the Rules and Regulations from time to time established by the Association with respect to the Common Areas and Easement for Ingress and Egress, Developer does hereby grant to each Owner and Occupant the nonexclusive right, privilege, and easement of access to and the use and enjoyment of the Common Areas and for purposes of ingress and egress to the Lots, an easement for ingress and egress as shown on the Subdivision Record

Map (“Easement for Ingress and Egress”) in common with all other Owners and Occupants and their parties having a right or interest therein and their respective successors and/or assigns. Subject to the remaining terms of this Declaration, the easement and rights granted pursuant to this Section 3.1 are and shall be permanent and perpetual, are nonexclusive, are appurtenant to, and shall pass and run with title to each Lot.

Section 4.2 Utility Easements. Developer reserves for itself and the Association the right to use, dedicate and/or convey to the appropriate local authority or agency, and/or to the appropriate utility company or other companies, rights-of-way or easements on, over or under the ground to erect, maintain and use, electric and telephone poles, wires, cables, cable television, conduits, storm sewers, sanitary sewers, surface drainage, water mains and other suitable equipment for the conveyance and use of electricity, telephone equipment, gas, sewer, water, surface water drainage, cable television, or other public conveniences or utilities, on, in and over the utility easements reflected on the Subdivision Record Map or as may hereafter appear on any plat of record of the Property subject to this Declaration, together with the right to construct within such reserved easement such swales and other surface water drainage systems as Developer shall, in its sole discretion, deem necessary.

Section 4.3 Additional Easements and Uses. For so long as Developer owns any Lot, Developer, and, thereafter, the Association, on its own behalf and on behalf of all Owners, who hereby appoint Developer and/or the Association, as the case may be, irrevocably, as their attorney-in-fact for such purposes, shall have the right to grant such additional electric, telephone, water, sanitary sewer, landscaping, irrigation, security, maintenance, drainage, gas, cable television and/or other utility, recreational or service easements or facilities (subject to applicable restrictions), in any portion of the Property, and to grant access easements or relocate any existing access easements in any portion of the Property, as Developer or the Association shall deem necessary or desirable for the proper operation and maintenance of the Property, or any portion thereof, or for the general welfare of the Owners, or for the purpose of carrying out any provisions of this Declaration, provided (a) such new easements or relocation of existing easements will not, in the opinion of the Board, unreasonably interfere with any Owner’s enjoyment of the portion of the Property owned by such Owner, (b) any required work is done at the sole cost and expense of the Association, and after completing such work, the Association will restore any portion of the Property which was affected to the same or as good a condition as existed immediately before the commencement of such work, and (c) following the completion of such work, the Association shall cause a survey to be made of the easement showing its location on the Property and cause the same to be recorded in the Probate Office. In furtherance of the rights granted in this Section, Developer and/or the Association may, as it deems necessary or desirable, provide for the simultaneous or concurrent use of any presently existing or additional easements by the Owners, Occupants, and the Owner’s and Occupant’s respective tenants, employees, guests, invitees, licensees and/or agents.

Section 4.4 Reservation of General Access Easement. Developer does hereby establish and reserve for itself and its successors and assigns and does hereby grant to the Association and their respective agents, employees, representatives, invitees, successors and assigns, a permanent and perpetual non-exclusive easement appurtenant over, across, through and upon each Lot for the purposes of (a) providing ingress to and egress from each Lot for (i) inspecting each Lot and any Improvements thereon in order to determine compliance with the

provisions of this Declaration and (ii) the performance of the respective duties of Developer and the Association hereunder, including, without limitation, taking any action required or permitted to be taken by Developer, the ARC and the Association pursuant to any of the terms or provisions of this Declaration; provided, however, that upon completion and occupancy of any dwelling, then the foregoing easement shall not be deemed to allow or grant any rights to Developer, the ARC or the Association to enter onto any Lot and dwelling located thereon, except in the case of emergencies, and shall be utilized only during normal business hours and then, whenever practicable, only upon advance notice to the Owner or Occupant of such Lot directly affected thereby, and (b) painting, repairs, mowing, removing, clearing, cutting or pruning underbrush, weeds, stumps or other unsightly growth and removing trash so as to maintain reasonable standards of health, fire, safety and appearance within the Property; provided, however, that such easement shall not impose any duty or obligation upon Developer, the ARC or the Association to perform any of the foregoing actions.

Section 4.5 Reservation of Easements With Respect to Common Areas.

(a) Easement Upon Common Areas. Developer does hereby establish and reserve, for itself, the ARC, the Association, and their respective agents, employees, representatives, invitees, successors and assigns, a permanent and perpetual nonexclusive easement appurtenant over, across, under, through and upon all of the Common Areas for the purpose of (i) constructing, installing, repairing and replacing any Improvements to the Property or to the Common Areas, and (ii) doing all other things reasonably necessary and proper in connection therewith; provided, however, that nothing in this sentence shall obligate Developer to undertake any of the foregoing.

(b) Changes in Common Areas. Developer does hereby establish and reserve unto itself and its successors and assigns the permanent right to change, modify and realign the boundaries of any of the Common Areas, any Lots, or other portions of the Property or of the Development owned by Developer. Developer further reserves the right, but shall not have any obligation, to convey by quitclaim deed to the Association at any time and from time to time any portion of the Property, or any Improvements thereto to be utilized as Common Areas, as Developer, in its sole discretion, may determine.

Section 4.6 Additional Documents. All Owners shall be required to execute such other documents as are necessary or convenient to effectuate the intent of this Declaration with respect to all easements which may be created pursuant to this Article III.

Section 4.7 Limitations. Any easements which may be created pursuant to this Article III shall be appurtenant to, and the benefits and burdens thereof shall pass along with the title to, every Lot and are further subject to the following limitations:

(a) All provisions of this Declaration and the Certificate of Formation and Bylaws of the Association;

(b) All the Rules and Regulations governing the use and enjoyment of the Property which may or may have been or may hereafter be adopted by the Association;

(c) All restrictions contained on any and all plats of all or any part of the Common Areas or any other part or parts of the Property; and

(d) Developer does hereby establish and reserve for itself and its successors and assigns and does hereby grant to the Association and its agents, employees, successors and assigns, a permanent and perpetual right and easement on, over, across, through and upon all Lots and all unimproved portions of any Lots for the purpose of taking any action necessary to effect compliance with the Architectural Standards and any watershed, soil erosion or environmental rules, regulations and procedures from time to time affecting or otherwise promulgated or instituted by any Governmental Authorities or the Board. The easement and right established, reserved and granted herein shall include, without limitation, the right to implement erosion control procedures and practices, the right to drain standing water and the right to take any other action which may be required in order to satisfy the requirements of the Architectural Standards or any Governmental Authorities, including, without limitation, any watershed, soil erosion, storm water discharge or environmental rules, regulations or procedures affecting the Property. Except in the case of an emergency situation or a perceived emergency situation, the exercise by Developer or the Association of the rights reserved or granted in this Section 3.8 shall not unreasonably interfere with the use or occupancy of any Improvement.

ARTICLE V ARCHITECTURAL CONTROL

Section 5.1 Architectural Control. The Board may appoint an Architectural Review Committee (“ARC”) consisting of not less than three (3) and no more than five (5) members to review and approve plans and specifications for Improvements to be constructed on the Lots to ensure compliance with the Declaration and Architectural Standards. The members of the ARC may consist of architects, landscape designers, and other professionals and need not be made up of members of the Association. Further, the ARC shall meet as often as is necessary to review and approve the plans and specifications. A majority of the members of the ARC shall constitute a quorum of the ARC and any submitted plans must be approved by at least a majority of the members present of the ARC. If the Board of Directors does not appoint an ARC, the Board shall act as the ARC.

Section 5.2 Architectural Standards. The ARC is hereby authorized to promulgate and amend or modify from time to time the Architectural Standards, which includes, without limitation, regulations governing policies, guidelines and minimum requirements to be satisfied with respect to the construction, location, landscaping and design of all Improvements on any Lot, the content and manner in which plans and specifications and other documentation and information concerning the construction of any Improvements on a Lot are to be submitted to and approved by the ARC, and any other matters affecting the construction, alteration, repair or maintenance of any Improvements on any Lot. The Architectural Standards adopted by the ARC shall be in addition to the provisions and requirements set forth in this Declaration and shall be binding upon and enforceable against all Owners. The ARC will be responsible for review and approval of initial proposed plans for all development and improvements of the Lots and any changes thereto following the initial construction.

Section 5.3 Approval of Plans and Specifications.

(a) IN ORDER TO PRESERVE THE ARCHITECTURAL AND AESTHETIC APPEARANCE AND THE NATURAL SETTING AND BEAUTY OF THE PROPERTY, TO ESTABLISH AND PRESERVE A HARMONIOUS DESIGN FOR THE PROPERTY AND TO PROTECT AND PROMOTE THE VALUE OF THE PROPERTY, THE LOTS AND ALL IMPROVEMENTS THEREON, NO IMPROVEMENTS OF ANY NATURE SHALL BE COMMENCED, ERECTED, INSTALLED, PLACED, MOVED ONTO, ALTERED, REPLACED, RELOCATED, PERMITTED TO REMAIN ON OR MAINTAINED ON ANY LOT BY ANY OWNER, OTHER THAN DEVELOPER, WHICH AFFECT THE EXTERIOR APPEARANCE OF ANY IMPROVEMENTS ON THE LOT UNLESS PLANS AND SPECIFICATIONS THEREFOR HAVE BEEN SUBMITTED TO AND APPROVED BY THE ARC IN ACCORDANCE WITH THE TERMS AND PROVISIONS OF SECTION 4.3(b) BELOW. WITHOUT LIMITING THE FOREGOING, THE CONSTRUCTION AND INSTALLATION OF ANY FURTHER IMPROVEMENTS ON THE LOT SHALL NOT BE UNDERTAKEN, NOR SHALL ANY EXTERIOR ADDITION OR CHANGE OR ALTERATION BE MADE (INCLUDING, WITHOUT LIMITATION, PAINTING OR STAINING OF ANY EXTERIOR SURFACE) TO ANY IMPROVEMENTS, UNLESS THE PLANS AND SPECIFICATIONS FOR THE SAME HAVE BEEN SUBMITTED TO AND APPROVED BY THE ARC IN ACCORDANCE WITH THE TERMS AND PROVISIONS OF SECTION 4.3(b) BELOW.

(b) The ARC is hereby authorized and empowered to approve all plans and specifications and the construction or alteration of all Improvements on any part of the Property. Prior to the commencement of construction, repair or replacement of any Improvements on any Lot, the Owner thereof shall submit to the ARC plans and specification and related data for all such Improvements, which shall include two copies of each of the following, if applicable:

- (i) Plans and specifications;
- (ii) Color samples and specifications of all exterior materials and finishes or proposed changes to exterior materials and finishes;
- (iii) Site development plan prepared by a licensed surveyor; and
- (iv) Such other plans, specifications or other information or documentation as may be required by the rules and regulations of the ARC;

(c) The ARC shall, in its sole discretion, determine whether the plans and specifications and other data submitted by any Owner for approval are acceptable. One copy of all plans, specifications and related data so submitted to the ARC shall be retained in the records of the ARC and the other copy shall be returned to the Owner submitting the same marked “approved,” “approved as noted” or “rejected.” The ARC will charge a reasonable fee, initially in the amount of \$250.00, to be paid by each Owner who submits a request to the ARC for approval of significant construction and alteration of

Improvements to cover the expense of reviewing plans and related data and to compensate any consulting architects, landscape architects, designers, engineers, inspectors and/or attorneys retained in order to approve or reject such plans and specifications and to monitor and otherwise enforce the terms hereof. The ARC may waive or increase the fee from time to time as needed. Notwithstanding anything provided herein to the contrary, an Owner may, without the necessity or requirement that ARC approval or consent be obtained, make interior improvements or alterations within his dwelling that do not affect exterior appearance of the dwelling or other Improvements in any way.

(d) The ARC shall have the right to disapprove any plans and specifications upon any ground which is consistent with the objectives and purposes of this Declaration, including purely aesthetic considerations, any failure to comply with any of the provisions of this Declaration or the rules and regulations of the ARC, failure to provide requested information, objection to exterior design, appearance or materials, objection on the ground of incompatibility of any such proposed Improvement or alteration with the scheme of development proposed for the Property, objection to the location of any proposed Improvements on any such Lot, objection to the landscaping plan for such Lot, objection to the color scheme, finish, proportions, style of architecture, height, bulk or appropriateness of any Improvement or any other matter which, in the sole judgment of the ARC, would render the proposed Improvement inharmonious with the general plan of development contemplated for the Property. The ARC shall have the right to approve any submitted plans and specifications with conditions or stipulations by which the Owner of such Lot shall be obligated to comply and must be incorporated into the plans and specifications for such Improvements. Approval of plans and specifications by the ARC for Improvements to one particular Lot shall not be deemed an approval or otherwise obligate the ARC to approve similar plans and specifications or any of the features or elements for the Improvements for any other Lot within the Property.

(e) The ARC shall have forty-five (45) days after the physical receipt of the plans and specifications and other required materials to “approve,” “approve as noted” or “reject” the request. In the event the ARC fails to “approve,” or “approve as noted,” in writing any such proposed plans and specifications within forty-five (45) days after such plans and specifications have been submitted, then the plans and specifications so submitted will be deemed to have been disapproved.

(f) Any revisions, modifications or changes to any plans and specifications previously approved by the ARC must be approved by the ARC in the same manner specified above.

(g) If construction of any approved Improvement has not substantially commenced (by clearing and grading, pouring of footing and otherwise commencing framing and other related construction work) within one (1) year of approval by the ARC of the plans and specifications for such Improvements, then no construction may be commenced (or continued) on such Lot and the Owner of such Lot shall be required to resubmit all plans and specifications for any such Improvements to the ARC for approval in the same manner specified above.

(h) Any approval of plans and specifications by the ARC pursuant to this Section 4.3 shall not be construed in any respect as a representation or warranty of the ARC, the Developer, or the Association that such plans are in conformity with any applicable rules, regulations, and requirements of any governmental authorities or that any such plan or the dwelling based thereon is architecturally sound or meets any standards of engineering compliance or is properly designed but is rather for aesthetic concerns only. It shall be the responsibility of each Owner who submits any such plans to the ARC to satisfy himself as to such conformity with all other requirements and proper design.

(i) Before any significant construction of Improvements to be constructed on the Lot in the Property begins, a \$1,000.00 Common Area repair deposit must be paid to the Association. If the road shoulders, roads and other Common Areas have not been damaged during construction, in the sole opinion of the ARC, the deposit, or a portion thereof, will be refunded.

(j) All construction or alterations of Improvements, once begun, must be completed within a reasonable time not to exceed twelve (12) months.

Section 5.4 Construction Without Approval. If (a) any Improvements are initiated, installed, maintained, altered, replaced or relocated on any Lot without ARC approval of the plans and specifications for the same, or (b) the ARC shall determine that any approved plans and specifications for any Improvements or the approved landscaping plans for any Lot are not being complied with, then, in either event, the Owner of such Lot shall be deemed to have violated this Declaration and the ARC shall have the right to exercise any of the rights and remedies set forth in Section 4.7 below.

Section 5.5 Inspection. The ARC, the Association, or any agent, employee or representative thereof may at any reasonable time and from time to time enter upon and inspect any Lot or any Improvements being constructed thereon in order to determine whether the approved plans and specifications therefor are being complied with. Any such entry shall not be deemed to be a trespass or any other wrongful act by the ARC.

Section 5.6 Limitation of Liability. Notwithstanding anything provided herein to the contrary, neither Developer, the ARC, the Association, nor any agent, employee, representative, member, shareholder, partner, joint venturer, officer or director thereof, shall have any liability of any nature whatsoever for any damage, loss or prejudice suffered which may be claimed, paid or incurred by any Owner or any other person on account of (a) any defects in any plans and specifications submitted, reviewed or approved in accordance with the provisions of this Article IV, (b) any defects, structural or otherwise, in any work done according to such plans and specifications, (c) any failure to approve or disapprove any plans, drawings, specifications or other data submitted by any Owner for approval pursuant to the provisions of this Article IV, (d) any construction or performance of any work related to such plans, drawings and specifications, (e) any bodily injuries (including death) to any Owner, Occupant or the respective family members, guests, employees, servants, agents, invitees or licensees of any such Owner or Occupant, or any damage to any Improvements or the personal property of any Owner, Occupant or his family members, guests, employees, servants, agents, invitees or licensees of such Owner or Occupant, which may be caused by, or arise as a result of any defect, structural or otherwise, in any

Improvements or the plans and specifications therefore or any past, present or future soil and/or subsurface conditions, known or unknown (including, without limitation, underground mines, tunnels or other geological formations or conditions on or under any Lot) and (f) any other loss, claim, damage, liability or expense, including court costs and attorneys' fees, suffered, paid or incurred by any Owner or Occupant arising out of or in connection with the use and occupancy of any Lot or any Improvements situated thereon.

Section 5.7 Enforcement and Remedies. In the event any of the provisions of this Article IV are breached or are not otherwise being complied with in all respects by any Owner or Occupant or his family members, guest, invitees, agents, employees or contractors of any Owner or Occupant, then the ARC and the Association shall each have the right, but not the obligation, at their option to (a) enjoin any further construction, repair, replacement or alteration on any Lot and require the removal or correction of any work in place which does not comply with the plans and specifications approved by the ARC for such Improvements, and/or (b) through their designated agents, employees, representatives and independent contractors, enter upon such Lot and take all action necessary to extinguish such violation or breach and/or (c) levy a fine (in an amount to be determined by the Board of Directors of the Association and set forth in the Rules and Regulations) against the Owner or Occupant which fine shall constitute a lien against the Lot. All costs and expenses incurred by the ARC or the Association in enforcing any of the provisions of this Article IV, including, without limitation, attorneys' fees, court costs, costs and expenses of witnesses, engineers, architects, designers, land planners and any other persons involved in the correction of nonconforming work, the completion of uncompleted work or in any judicial proceeding, together with any other costs or expenses incurred by the ARC or the Association in causing any Owner or such Owner's contractors, agents or invitees to comply with the terms and provision of this Article IV, shall be paid by such Owner, shall constitute an individual Assessment to such Owner and, if the same is not paid when due, shall become a lien on the Lot as provided for in Article VI below and be subject to foreclosure as provided for therein. Notwithstanding anything provided herein to the contrary, the rights and remedies of the ARC and the Association set forth herein shall not be deemed exclusive of any other rights and remedies which the ARC or the Association may exercise at law or in equity or hereunder.

ARTICLE VI RESTRICTIONS

Section 6.1 Rules and Regulations of the Association. The Association is authorized to promulgate, amend and enforce Rules and Regulations concerning the operation and use of the Property; provided that such Rules and Regulations are not contrary to or inconsistent with the Covenants or Certificate of Formation. A copy of the Rules and Regulations shall be furnished by the Board of Directors to each Owner prior to the time they become effective. All present and future Owners and Occupants of the Lots and any person who uses any part of the Property in any manner, are subject to, and shall comply with the provisions of the Covenants and the Rules and Regulations. The acquisition, rental or occupancy of a Lot or the use of any part of the Property by any person shall constitute his agreement to be subject to and bound by the provisions of this Declaration and the Rules and Regulations, and such provisions shall be deemed to be enforceable as equitable servitudes and covenants running with the land and shall bind any person having at any time any interest or estate in such Lot, as though such provisions were recited and stipulated in full in each and every deed of conveyance or lease thereof. The Association may

promulgate enforcement provisions for violation of any Rule or Regulation by an Owner or Occupant, his family members, guests, invitees, lessees or renters, including the payment of fines for such violations.

Section 6.2 Restrictions on Use. The use of the Property is subject to the following restrictions:

(a) Each Lot is restricted to residential use by a Single Family Unit and the parking areas and driveways are limited to the parking of passenger automobiles. No commercial vehicle shall be parked on the Property, except to make deliveries. The garages shall be used for the parking of vehicles and storage space and shall not be used as living space.

(b) There shall be no obstruction of the Common Areas, nor shall anything be kept or stored in the Common Areas (except appropriate furniture on the patios or terraces appurtenant to any Improvement located on a Lot), nor shall anything be constructed on or planted in or removed from the Common Areas, nor shall the Common Areas in any other way be altered without the prior written consent of the Association.

(c) No immoral, improper, offensive or unlawful use shall be made of any Lot, Common Area, or any part thereof, and all laws, zoning ordinances and regulations of all Governmental Authorities having jurisdiction over the Property shall be observed.

(d) No Owner shall permit anything to be done or kept in or on his Lot or in the Common Areas which will result in any increase of fire or hazard insurance premiums or the cancellation of insurance on any part of the Property, or which would be in violation of any law.

(e) No noxious or offensive activities shall be carried on, nor shall any outside lighting or sound speakers or other sound producing devices be used, nor shall anything be done, on any part of the Property which in the judgment of the Board of Directors of the Association, may be or become an unreasonable annoyance or nuisance to the other Owners.

(f) No Owner shall cause or permit anything to be placed on the Common Areas immediately surrounding the Lot. No awning, canopy, window air conditioning unit, shutter, or other fixture shall be affixed to or placed upon the exterior walls or roof of any dwelling or Improvement on any part of the Common Areas.

(g) No satellite dishes over one (1) meter shall be allowed on the Property at any time. Satellite dishes less than one (1) meter shall not be allowed on any part of the Common Areas. Satellite dishes less than one meter may be allowed on the Lot with the express approval of the Board of Directors as to location of the receiving equipment and dish.

(h) Outside clotheslines or other outside facilities for drying or airing clothes shall be prohibited on any Lot. No clothing, rugs or other items shall be hung, placed or allowed to remain on any railing, fence or wall. No clothes, sheets, blankets, laundry of

any kind or other articles shall be hung out or exposed from or on any part of the Common Areas. The Common Areas shall be kept clear of rubbish, debris and other unsightly materials.

(i) No one shall use or permit to be brought into any Lot or upon any of the Common Areas and facilities any inflammable oils or fluids such as gasoline, kerosene, naphtha or benzene, or other explosives or articles deemed extra hazardous to life, limb or property, without the written consent of the Board of Directors of the Association.

(j) No Owner or Occupant may conduct any business, trade, garage sale, moving sale, rummage sale, tag sale or similar activity at or about the Property, whether on a Lot or otherwise unless scheduled as a planned community activity approved by the Association, except that an Owner or Occupant residing in a dwelling or other Improvement on a Lot may conduct business activities on the Lot so long as: (i) the existence or operation of the business activity is not apparent or detectable by sight, sound or smell from the Lot or from outside any dwelling or other Improvement located on the Lot; (ii) the business activity conforms to all zoning and other legal requirements for the Property; (iii) the business activity does not, in the Board's reasonable judgment, generate any vehicular or pedestrian traffic or a number of vehicles being parked in the Property; (iv) the business activity is consistent with the residential character of the Property and does not constitute a nuisance, or a hazardous or offensive use, or threaten the security or safety of other residents of the Property, as may be determined in the sole discretion of the Board. The terms "business" and "trade", as used in this provision, shall be construed to have their ordinary, generally accepted meanings and shall include, without limitation, any occupation, work, or activity undertaken on an ongoing basis which involves the provision of goods or services to persons other than the provider's family and for which the provider receives a fee, compensation, or other form of compensation.

(k) No animal or pet shall be kept for commercial purposes or be allowed to create or cause any disturbance or nuisance of any kind, and if an animal or pet does cause or create a nuisance or an unreasonable disturbance, said animal or pet shall be permanently removed from the Property within seven (7) days from the date the Owner receives written notice from the Board of Directors to remove such animal or pet. The Owner of any pet or animal shall be liable for any and all damage caused by such animal or pet to any part of the Property. Notwithstanding the foregoing, no more than two (2) domesticated pets may be kept on any Lot without the permission of the Board of Directors and no potbellied pigs, venomous snakes, or animals, including particular breeds of dogs and cats, deemed vicious or dangerous by the Board may be brought onto or kept on the Property at any time. The Board of Directors shall be entitled to adopt Rules and Regulations relating to the maintenance of pets on the Property and the Association may charge a fee or deposit for the privilege of maintaining pets on the Property.

(l) No structure of a temporary character, trailer, tent, shack, carport, garage, barn, fence or other outbuilding shall be erected by any Owner, other than the Developer, on any portion of the Property, at any time, either temporarily or permanently, without the prior written approval of the Association.

(m) The display or discharge of firearms or fireworks on the Common Areas is prohibited; provided, however, that the display of lawful firearms on the Common Areas is permitted by law enforcement officers and also is permitted for the limited purpose of transferring firearms across the Common Areas to or from an Owner's Lot so long as the firearm is not loaded and not carried in a threatening manner. The terms "firearms" includes "B-B" guns, pellet guns and other firearms of all types, regardless of size.

(n) Lot Owners and Occupants are prohibited from smoking or vaping inside a dwelling.

(o) One (1) generator per Lot may be used during power outages and shall be approved by the Architectural Review Board before being installed.

Section 6.3 Landscaping.

(a) Each Owner shall be responsible for the cost of installation, replacement and maintenance of all landscaping in the back yard of the Lot. The landscaping plan shall be submitted to the ARC for approval prior to installing or changing the plant materials. The Association shall be responsible for maintenance of all landscaping in the front and side yards of the Lots.

(b) No Owner shall allow the lawn grass on his or her Lot to grow to a height where it looks unkempt, in the sole discretion of the Association.

(c) No hedge or shrubbery planting which obstructs sight-lines of streets and roadways shall be placed or permitted to remain on any Lot. The determination of whether any such obstruction exists shall be made by the Association, whose determination shall be final, conclusive and binding on all Owners.

(d) No rocks or other substances shall be placed on any Lot as a front or side yard border. No bird baths, fountains, waterfalls, pools, ponds, reflectors, flag poles, statues, lawn sculptures, lawn furnishings, artificial plants, rock gardens, rock walls, bird houses or other fixtures and accessories shall be placed or installed within the front or side yards of any Lot, or on the rear (back) yard of any Lot if it can be seen from the street.

(e) No vegetable, herb or similar gardens or plants shall be planted or maintained in the front or side yards of any Lot or in the rear (back) yard of any Lot if the same would be visible from any street.

(f) The Association may from time to time promulgate Rules and Regulations adopting an approved list of plant life which may be utilized on any Lot, which Rules and Regulations may require that either a minimum dollar amount be established and utilized as the landscaping budget for each Lot, or that a minimum number of plantings of certain sizes, types and specifications be used on any Lot.

(g) Seasonal or holiday decorations (e.g., Christmas trees and lights, pumpkins, Easter decorations) shall be promptly removed from each Lot within fifteen (15) days after such holiday.

Section 6.4 Storm Drains. Developer has installed, or will cause to be installed, pipes, swales, headwalls, flumes, surface inlets and other structures necessary for proper control of storm drainage and runoff. Owners shall not alter, modify, or in any way interfere with the functionality of these structures. Additionally, Owners shall not allow debris, grass clippings, fences or any other items to impede the function of the drainage structure and shall maintain the same.

Section 6.5 Exterior Lighting. All exterior lighting, including, without limitation, free standing lighting and utility (e.g., flood) lights, must be of a design and in a location approved by the ARC.

Section 6.6 Exterior Materials and Finishes. No exterior materials and finishes of any Improvement on any Lot may be changed except with approval of the Association. All wood surfaces utilized on the exterior of any dwelling, including windows and doors, shall be painted or stained at all times in colors approved by the Association.

Section 6.7 Fences. No fences, including but not limited to chain link, vinyl coated, wire or above ground electric fences, shall be permitted on the Property other than those built by the Developer pursuant to the development plan.

Section 6.8 Windows, Window Treatments and Doors.

(a) Reflective glass shall not be permitted on any portion of any dwelling or Improvement. No foil or other reflective materials shall be installed on any windows or used for sun screens, blinds, shades or other purposes.

(b) The ARC may adopt guidelines for the types of windows and materials from which windows may be allowed on any dwelling. Burglar bars or doors (including wrought iron doors) are not permitted. No aluminum or metal doors with glass fronts (e.g., storm doors) shall be allowed on any dwelling or Improvement. Appropriate window treatments shall be used on all windows. Sheets, bed linens, blankets, foil and paper or plastic bags are not appropriate window treatments.

Section 6.9 Mailboxes. Mailboxes shall be maintained for the Lot as installed by the Developer. Mailboxes shall contain only the name and address of the Owner or Lot. No further inscription, paintings, ornaments or artistry shall be allowed on the mailboxes.

Section 6.10 Outdoor Furniture and Recreational Facilities.

(a) No furniture shall be placed, kept, installed, maintained or located in or on the front or side yards or areas of a Lot. Any furniture placed, kept, installed, maintained or located at the rear of or behind a dwelling shall, to the greatest extent practicable, be located so that the same shall not be visible from any street.

(b) Basketball backboards and goals are not allowed on the Lot.

(c) Barbecue grills or other types of outdoor cooking equipment and apparatus shall be located only at the rear of a dwelling and, to the extent practicable, shall not be visible from any street.

Section 6.11 Trash, Rubbish and Nuisances.

(a) No trash, garbage, rubbish or debris of any kind shall be dumped, placed or permitted to accumulate upon any portion of the Property nor shall any nuisance or odors be permitted to exist or operate upon or arise from any Lot which would render any portion thereof unsanitary, unsightly, offensive or detrimental to persons using, occupying or owning any other Lots. Noxious or offensive activities shall not be carried on in or from any Lot or in any part of the Common Areas, and each Owner and Occupant shall refrain from any act or use of a Lot which could cause disorderly, unsightly or unkempt conditions, result in the cancellation of or increase in insurance coverage or premiums for any portion of the Property or be in violation of any law, statute, ordinance, rule, regulation or requirement of any Governmental Authority. Without limiting the generality of the foregoing, no horns, whistles, bells, speakers or other sound devices, other than reasonable security and fire alarm devices used exclusively for such purposes, shall be located, used or placed upon any Lot. Any Owner or Occupant or any of the respective family members, guests, invitees, servants, agents, employees or contractors of such Owner or Occupant who dumps, places or allows trash or debris to accumulate on his or her Lot or on any other portion of the Property shall be liable to the Association for all costs incurred by the Association to remove the same.

(b) Trash, garbage and any other refuse or waste shall not be kept on any Lot except in sanitary containers or garbage compactor units. Trash cans and containers shall at all times be kept at the rear of or inside a dwelling and shall be screened from view from streets and adjacent Lots and dwellings by appropriate landscaping or fencing approved by the Association. Each Owner shall promptly deposit all trash in the appropriate receptacle provided. Owners shall not use any garbage disposal containers of the Developer for trash disposal.

(c) No outdoor burning of trash, garbage, leaves, wood, shrubbery or other materials shall be permitted on any Lot or other portion of the Property.

Section 6.12 Recreational Vehicles and Machinery and Equipment.

(a) Mobile homes, motor homes, trailers of any kind, campers, motorized carts and all-terrain vehicles, tractors, construction machinery and equipment of any nature, golf carts, boats and any other type of water craft, including boat trailers, and any other similar types of vehicles, machinery or equipment shall not be permitted, stored or allowed to remain on the Common Areas or the Lot except inside the garage. The Common Areas shall not be utilized for the parking or storage of any of the foregoing vehicles, recreational vehicles, machinery or equipment. Any bicycles, lawnmowers, tools or any other vehicles, machinery or equipment brought onto a Lot shall be stored in the garage or dwelling.

(b) Any vehicle which is inoperable shall be immediately removed from the Property. No Owner or Occupant shall repair or restore any vehicle, machinery or equipment of any kind upon or within any Lot or on any portion of the Common Areas, except for emergency repairs and then only to the extent necessary to enable the immediate movement thereof to a proper repair facility located outside of the Property.

Section 6.13 Signage. A maximum of two (2) signs, in size and color to be approved by the ARC, may be posted on a Lot upon a single sign slab approved by the ARC, at a height not to exceed five (5) feet from the ground level advertising the Lot for sale, or during the construction of the dwelling, containing information identifying the builder of such dwelling. No other signage, banners, flags, or advertising posters shall be allowed without obtaining ARC approval. The location of such signage shall be established by the ARC but in no event shall any signage authorized by this Section or which may be approved by the ARC be attached, nailed or otherwise adhered to any tree or other plant life on a Lot.

Section 6.14 Construction of Improvements.

(a) During the construction of any Improvements, (i) all Lots subject to such construction shall be maintained in a clean condition, free of debris and waste material, (ii) all unused construction materials shall be stored, to the extent practicable, out of view from any street, (iii) all construction trash, debris and rubbish on each Lot shall be properly disposed of outside the Property immediately, and (iv) any temporary or portable toilet will be placed out of view from any street.

(b) During the construction of any Improvements, care should be taken that construction equipment and the vehicles of all contractors, subcontractors, laborers, materialmen and suppliers do not interfere with the use of the Common Area parking for the Owners and Occupants.

(c) Any Improvements made to the Lot shall be constructed in compliance with any rules established by the Association, all applicable federal, state, county and local laws, ordinances, rules, regulations, and zoning and building code requirements. Each Owner shall be solely responsible for obtaining from the appropriate Governmental Authorities all necessary permits and licenses and otherwise paying all required fees for the construction of any Improvements on such Owner's Lot. Each Owner shall also be responsible for strict compliance with any rules established by the Association and all governmental requirements, both during and after completion of construction of any Improvements on such Owner's Lot.

(d) When any Owner submits to the ARC plans and specifications for construction of Improvements in accordance with Article IV above, the name of the building contractor selected by such Owner for construction of such Improvement shall also then be submitted to the ARC; however, if the identity of the building contractor is not known at that time, then the name of the building contractor will be submitted when determined prior to construction. The ARC shall have the right, in its sole discretion, to approve or disapprove of any building contractor so selected by such Owner. Each building contractor approved by the ARC in accordance with this Section 5.14(d) will be required

to remit to the ARC a refundable damage/clean up deposit (the “Deposit”) in an amount established by the ARC or the ARC. Should such building contractor damage or fail to properly clean up the Property or Common Areas as required herein, or any supplemental rules or regulations promulgated by the ARC, the ARC may, in its sole discretion, initiate appropriate action to remediate any such condition at such building contractor’s expense. The cost of any such remediation shall be deducted from the Deposit and any amount expended by the ARC in excess of the Deposit in remediating such condition shall be billed to such building contractor. Within thirty (30) days of the completion of any improvement, the ARC shall refund to such building contractor any unexpended portion of the deposit.

Section 6.15 Swimming Pools. Outdoor hot tubs, reflecting ponds, saunas, whirlpools, or lap pools shall not be constructed, installed or maintained on any Lot.

Section 6.16 Traffic Regulations. The Association shall be entitled to make and enforce any traffic Rules and Regulations it deems appropriate, including the right to levy fines for the violation thereof. In the event of any conflict between the provisions of the laws of the State of Alabama and the traffic Rules and Regulations promulgated by the Association, the more restrictive shall govern.

Section 6.17 Lease of Lots. Entire Lots or any dwelling thereon may be leased by the Owners; provided, however, that any such lease and the rights of any tenant thereunder are hereby made expressly subject to the power of the Association to prescribe reasonable Rules and Regulations relating to the lease and rental of Lots or any dwelling and to enforce the same directly against such tenant or other Occupant by the exercise of such remedies as the Board deems appropriate; provided, however, that no restrictions shall be imposed which shall have the individual or cumulative effect of prohibiting or materially impairing the rental or lease of Lots or any dwelling. No individual rooms may be rented. Further, all leases must be in writing, with a copy provided to the Association upon request by the Association. This restriction on use shall be a covenant running with each Lot, creating a burden on each single Lot and Owner for the benefit of every other Lot and Owner. No lease shall be for less than six (6) months and no more than one (1) Single Family Unit per Lot or two (2) people per bedroom of any dwelling on a Lot shall occupy a Lot. Notwithstanding anything contained in this Section to the contrary, each Owner shall be responsible for the actions of his tenants and the Occupants and nothing herein or in any such lease shall relieve an Owner of his obligations under the Covenants. The provisions of this Section shall not be applicable to the Developer who is irrevocably empowered without any limitation at all times, whether for permanent or temporary occupancy to sell, lease or rent Lots, or any dwelling or other Improvement thereon, for any period and under any terms to any lessees or purchasers or transferees with the right to take any action necessary to consummate the sale or rental of said Lots, including, but not limited to, the right to maintain model Lots with any Improvements thereon, post signs, have employees in the offices maintained on the Property, use the Common Areas and show Lots and any Improvements thereon to prospective tenants or purchasers. Sales and rental office signs and all items pertaining to the rental or sale of Lots shall not be considered Common Areas and shall remain the property of the Developer.

Section 6.18 Right of Access. Each Owner or Occupant grants a right of access to his Lot to the Association, and any other person authorized by the Association for the purpose of making inspections and for the purpose of correcting any condition originating on his Lot and

threatening other Lots, Common Areas, or for the purpose of performing installations, alterations or repairs to the mechanical or electrical services or other Common Areas within his Lot, if any, or to correct any condition which violates the provisions of any Mortgage covering another Lot, or to enforce any provision of the Covenants, provided that requests for entry are made in advance and that such entry is at a time reasonably convenient to the Owner or Occupant. In case of an emergency, such right of entry shall be immediate whether the Owner is present at the time or not. Each Owner further grants a right of access to his Lot to the Developer or his agent, or other authorized representative who is not Developer's agent, for the purpose of making all repairs required by any warranty delivered to the Owner at the closing of his Lot. To the extent that damages inflicted on the Common Areas or any Lot through which access is taken, the Owner or the Association, if it caused the same, shall be liable for the prompt repair thereof.

Section 6.19 Limitation of Liability. The Association shall not be liable for any failure of water or power supply, telephone, security, fire protection or other service to be obtained by the Association or paid for out of the Common Expense funds, for problems resulting from the operation or lack of operation of sewer lines servicing the Property, or for injury or damage to a person or property caused by the natural elements or resulting from electricity, water, snow or ice which may leak or flow from any portion of the Common Areas or from any wire, pipe, drain, conduit, appliance or equipment, however, this provision does not relieve the Association from maintenance responsibility or for damage to the Lots arising from or related to water intrusion from the Common Areas on account of maintenance or lack thereof. The Association shall not be liable to the Owner of any Lot for loss or damage, by theft or otherwise, of articles which may be stored upon any of the Common Areas. No diminution or abatement of the Common Expense assessments, as herein elsewhere provided, shall be claimed or allowed for inconvenience or discomfort arising from the making of repairs or improvements to the Common Areas or to any Lot, or from any action taken by the Association to comply with any law or ordinance or with the order or directive of any municipal or other Governmental Authority or judicial authority or for the dispossession of the Owner by reason of fire or other casualty, except to the extent covered by insurance.

Section 6.20 Enforcement. If a determination is made by the ARC or Board that any of the restrictions in this Article V or the Architectural Standards are being or have been violated upon any Lot, then the ARC shall so notify the Owner in writing, specifying the violation. If within fifteen (15) days from such notification, the ARC shall make a second determination that sufficient progress has not been made to remedy the violation, the ARC may itself, direct such actions to be taken as shall be necessary or appropriate to remedy such violation, including, without limitation, those remedies set forth in Section 4.7 herein. The Owner shall be liable for the cost and expense of all such actions, including legal fees, and the ARC may treat all such costs and expenses therefor as a charge which shall become a lien against the Lot. The Association, any Lot owner, and/or the ARC may initiate a proceeding at law or in equity to enforce the restrictions set forth in this Article V, or the Architectural Standards and/or to seek damages as incurred as a result of any breach or violation of the same.

Section 6.21 Failure of the Association to Insist on Strict Performance; No Waiver. Failure of the Association to insist in any one or more instances upon the strict performance of any provision of the Covenants, or to exercise any right or option herein contained, or to serve any notice or to institute any action shall not be construed as a waiver or a

relinquishment from the future performance of such term, covenant, condition or restriction, but such term, covenant, condition or restriction shall remain in full force and effect. The receipt by the Association of any assessment from an Owner with knowledge of the breach of any covenant hereof shall not be deemed to be a waiver of such breach and no waiver by the Association of any provision hereof shall be deemed to have been made unless expressed in writing and signed by the Board of Directors of the Association.

Section 6.22 Use by Developer. Subject to the rights of the Mortgagees hereunder, neither the Owners nor the Board of Directors of the Association nor their use of the Property or application of these Covenants shall interfere with completion of Improvements, sales of the Lots, construction of Improvements or development of the Property by the Developer. Subject to the rights of the Mortgagees hereunder, the Developer may make such use of the unsold Lots and the Common Areas as may facilitate such completion and sale, including, but not limited to, maintenance of a sales office, management office and model units, the showing of the Property and the Lots therein, the display of signs, balloons, banners and marketing materials thereon and therein and the holding of sales and promotional activities thereon. These rights exist so long as Developer holds any Lot in the Property for sale in the ordinary course of business. The Developer expressly reserves the right to lease any Lot which it may own in the Property on such terms as it may deem proper and desirable and may transfer Lots subject to such lease.

Section 6.23 Common Areas. The Developer shall convey to the Association, the title to the Common Areas as shown on the Subdivision Record Map for the benefit and use of the Owners. The Association shall assess the Common Areas in the name of the Association for tax purposes, improve and maintain the Common Areas and obtain and maintain liability insurance coverage on the Common Areas in the name of the Association.

Section 6.24 Compliance with Governmental Regulations. Each Owner and Occupant shall at all times comply with all applicable laws, ordinances, statutes, rules, regulations, requirements and code provisions of the Governmental Authorities.

Section 6.25 Additional Regulations. In addition to the restrictions set forth in these Covenants, the (i) Association shall have the right, in its sole discretion, from time to time and at any time to adopt, modify and amend the Rules and Regulations in order to impose such other, further or different requirements or restrictions which shall be binding on all Owners and Lots, including the adoption of additional or different requirements or restrictions which shall be binding on all Owners and Lots, including the adoption of additional or more specific requirements and restrictions governing the improvement and use of any Lot, and (ii) the Association shall have the right from time to time and at any time to adopt, modify and amend such Rules and Regulations as the Association, in its sole discretion, determines to be in the best interests of all Owners, which Rules and Regulations shall be binding on all Owners and Lots.

ARTICLE VII COVENANT FOR ASSESSMENTS

Section 7.1 Affirmative Covenant to Pay Assessments. Each Owner, by acceptance of a deed for a Lot, whether or not it should be so expressed in such deed, shall be obligated and hereby covenants and agrees to pay to the Association (or to an independent entity

or agency which may be designated by the Association to receive such monies), in the manner set forth herein: (i) Annual Assessments or charges levied each year by the Association, (ii) Special Assessments for capital improvements, such Assessments to be established and collected as hereinafter provided, and (iii) Individual Assessments which may be levied against any Lot and the Owner thereof as a result of such Owner's or Occupant's failure to comply with the terms of this Declaration, the Rules and Regulations adopted by the Board, or as a result of damage caused by an Owner or Occupant. Notwithstanding the foregoing, Lots owned by Developer, shall not be subject to any Assessment by the Association. The Annual Assessments, Special Assessments and Individual Assessments, together with interest, late charges, costs and reasonable attorneys' fees, shall also be a charge on each Lot and shall be a continuing lien upon each Lot against which such Assessment is made, which lien may be enforced in the manner hereinafter provided. Each such Assessment, together with interest, late charges, costs and reasonable attorneys' fees shall also be the personal obligation of the person who was the Owner of such Lot at the time when the Assessment fell due or was due.

Section 7.2 Purpose of Assessments. The Assessments levied by the Association shall be used exclusively for the preservation of the appearance, value and amenities of the Property, and in particular for the improvement, preservation, maintenance and administration of the Common Areas (including, without limitation, the payment of Common Expenses under Article VII below) and of any easement in favor of the Association and/or the Owners/Occupants, as well as for such other purposes as are properly undertaken by the Association. No profit, gain, or other benefit is to be derived by the Association from the Assessments, but, instead, such funds shall be expended only as agent for the Owners, and no part of the net earnings of the Association shall inure (other than by acquiring, constructing or providing management, maintenance, and care of the Common Areas) to the benefit of any individual.

Section 7.3 Individual Assessment. Any expenses incurred by the Association in enforcing any of the provisions of this Declaration against any specific Owner or Occupant shall be deemed an Individual Assessment against such Owner and the respective Lot owned by such Owner. Any expenses incurred by the Association as a result of damage caused by an Owner or Occupant shall be levied against the Owner and his Lot as an Individual Assessment. Such Individual Assessment shall be levied by the Association and shall be specified in a notice to the Owner, which notice shall also specify the due date for payment of the same.

Section 7.4 Annual Assessments. The Association shall levy Annual Assessments in such amounts as are necessary to meet the Common Expenses (as defined in Article VII below) and such other recurring or projected expenses as the Board of Directors of the Association may deem appropriate. The Annual Assessment for the Subdivision shall commence on January 1 of each year, and shall be paid in advance.

Section 7.5 Special Assessments. In addition to the Annual Assessments specified in Section 6.4 above, the Association may levy, at any time, one or more Special Assessments for the purpose of defraying, in whole or in part the cost of any construction, reconstruction, repair or replacement of a capital improvement upon the Common Areas, provided that any such Assessment must have the assent and approval of (a) at least fifty-one percent (51%) of the Owners who are voting in person or by proxy at a meeting duly called for this purpose, and (b) to the extent Developer is the Owner of any Lot in the Subdivision, the approval of Developer.

Section 7.6 Special Meeting. Written notice of any meeting called for the purpose of taking any action authorized under Section 6.5 above shall be sent to all Owners not less than fourteen (14) days but no more than sixty (60) days in advance of the meeting. At the first such meeting called, the presence of Owners, either in person or by proxy, entitled to cast fifty-one percent (51%) or more of all votes in the Association shall constitute a quorum. If the required quorum is not present, another meeting may be called subject to the same notice requirements and the required quorum at the subsequent meeting shall be one-half of the required quorum at the preceding meeting.

Section 7.7 Amount of Assessments. Both Annual and Special Assessments must be fixed at a uniform rate for all Lots within the Subdivision, and shall commence upon the closing of the sale of the Lot from the Developer to a third party purchaser, and shall be due and payable in such manner as established by the Board of Directors of the Association. The Board of Directors of the Association shall fix the amount of the Annual Assessment against each Lot at least thirty days in advance of each Annual Assessment period. Written notice of the Annual Assessment shall be sent to every Owner. The due date for the payment of Annual Assessments shall be established by the Board of Directors in such notice (but such due date shall be, at a minimum, thirty (30) days from the date of such notice).

Section 7.8 Certificate. The Association shall, upon written demand by Owner or Mortgagee and for a reasonable charge, furnish a certificate signed by an officer or agent of the Association setting forth whether the assessments levied against the Lot have been paid. A properly executed certification of the Association as the status of the Assessment on a Lot is binding upon the Association as of the date of its issuance.

Section 7.9 Effect of Non-Payment of Assessments; Liens; Remedies.

(a) The obligation to pay any assessment (whether Annual, Special or Individual) or installment thereof due the Association shall be in default if such assessment or any installment thereof is not paid to the Association on or before the due date for such payment. When in default, the delinquent assessment or delinquent installment due the Association shall bear interest at the rate established by the Board not to exceed the maximum legal rate on judgments allowed by law or eighteen percent (18%) until such delinquent assessment or installment and all interest due thereon has been paid in full. The Association shall have a lien against Lot for delinquent assessments. Said lien shall secure and does secure the monies due for all assessments then or thereafter levied against the Lot, and such lien shall also secure interest, if any, which may be due on the amount of any delinquent assessment owing the Association. Said lien shall also secure all costs and expenses, including late penalties and reasonable attorneys' fees incurred by the Association in collecting delinquent assessments and enforcing the lien upon said Lot. The lien granted to the Association may be foreclosed in the same manner as real estate mortgages in the State of Alabama, but the Association shall give reasonable advance notice of its proposed action to the Owner, the Mortgagee and all other lienholders of record of the Lot.

(b) The lien herein granted to the Association may be foreclosed by the Association, or its successors or assign, (the "Foreclosing Party") in the same manner as

real estate mortgages in the State of Alabama, and the Foreclosing Party, or its agent, may sell the Lot at a public sale before the door of the courthouse of the county or counties, as may be required, in which the Lot or any part of thereof is situated, after having first given notice of the time, place and terms of sale at least once a week for three (3) successive weeks preceding the date of such sale in some newspaper published in said county or counties, and after having given reasonable advance notice of the foreclosure sale to the Owner, any Mortgagee, and all other lienholders of record of the Lot. At any such sale, the Foreclosing Party may execute and deliver to the purchaser a deed and conveyance of the Lot. In the event of any sale under this Declaration by virtue of the exercise of the powers herein granted, or pursuant to any order in any judicial proceedings or otherwise, the Lot may be sold as an entirety and the Foreclosing Party in its sole discretion may elect to sell the personal property covered by this Declaration at one or more separate sales in any manner permitted by the Uniform Commercial Code of the state of Alabama, and one or more exercises of the powers herein granted shall not extinguish or exhaust such powers. If the lien granted herein is now or hereafter further secured by any chattel mortgages, pledges, contracts of guaranty, assignments of lease or other security instruments, then Foreclosing Party at its option may exhaust the remedies granted under any of said security instruments or this Declaration either concurrently or independently, and in such order as Foreclosing Party may determine. Said sale may be adjourned by Foreclosing Party, or its agent, and reset at a later date without additional publication; provided that an announcement to that effect be made at the scheduled place of sale at the time and on the date the sale is originally set. In the event of any sale of the Lot as authorized by this Section, all prerequisites of such sale shall be presumed to have been performed, and in any conveyance given hereunder all statements of facts, or other recitals therein made, as to the nonpayment or nonperformance by the Owner or as to the advertisement of sale, or the time, place and manner of sale, or as to any other fact or thing, shall be taken in all courts of law or equity as prima facie evidence that the facts so stated or recited are true. Additionally, any foreclosure sale or sale of all or any portion of the Lot under the power herein granted, Foreclosing Party may credit bid for and purchase the Lot if the highest bidder therefor, but all proceeds of such sale shall be applied: (a) first, to the expenses of such sale and of all proceedings in connection therewith, including fees and expenses of Foreclosing Party's attorneys; (b) then to the repayment of the lien granted herein; and (c) finally the remainder, if any, shall be paid to such parties as are legally entitled to it, after deducting any expenses incurred in ascertaining the identity of such parties, or as may otherwise be provided by law.

Section 7.10 Damages. In addition to the rights and remedies set forth above, if any Owner or Occupant (or any Owner's or Occupant's contractor, family members, guests or invitees) shall violate or attempt to violate any of the covenants and restrictions set forth herein, then Developer, the Association, the ARC, or any Owner, jointly and severally, shall each have the right to prosecute proceedings at law for the recovery of damages against such Owner as a result of such violations and/or maintain a proceeding in equity against such Owner to enjoin such violation; provided, however, that the rights and remedies set forth herein shall be deemed to be cumulative of all other rights and remedies available at law or in equity. In any such proceedings, Developer, the Association, the ARC or any Owner, jointly and severally, shall be entitled to recover all costs and expenses, including reasonable attorneys' fees, incurred by any of them in such proceedings, as well as interest on all unpaid amounts as specified in Section 6.9 above. The

failure of Developer, the Association, the ARC or any Owner to institute proceedings for any one (1) or more violations of this Declaration shall not constitute approval of the same or be construed as a waiver of any right of action contained herein for past or future violations of said Declaration.

Section 7.11 Exempt Property. The Board shall have the right to exempt any portion of the Property from the Assessment and liens created herein provided that such part of the Property exempted is used (and as long as it is used) for any of the following purposes:

- (a) As an easement or other interest therein dedicated and accepted by the local public authority and devoted to public use; or
- (b) As a Common Area.

ARTICLE VIII MAINTENANCE RESPONSIBILITIES

Section 8.1 Responsibilities of Owners -Maintenance.

(a) Unless specifically identified herein as being the responsibility of the Association, the maintenance and repair of all Improvements situated on the Lots or therein shall be the responsibility of the Owner of such Lot. Each Owner shall be responsible for maintaining his, her or its Lot, as the case may be, in a neat, clean and sanitary condition, both inside and outside of any dwellings or Improvements thereto.

(b) Each Owner agrees as follows:

(i) To perform all maintenance, repairs and replacements which are his obligations under subparagraph (a) of this Section 7.1;

(ii) To pay all utilities as herein provided and all taxes levied against his Lot;

(iii) Not to make any addition or alteration to the Lot or any dwelling or other Improvement thereon or to the Common Areas or to do any act that would impair the structural soundness, safety or overall design and aesthetics scheme of any part of the Property or that would impair any easement or right of an Owner without the prior written consent of the Board or ARC as provided in Article V of these Covenants;

(iv) Not to make any alteration, addition, improvement, decoration, repair, replacement or change to the Common Areas, or to any outside or exterior portion of the any Improvement located on a Lot, excluding any alteration or additions made pursuant to the procedure described in subparagraph (iv) above and including, but not limited to, altering in any way exterior doors and windows, affixing outshutters to windows or painting any part of the exterior part of such Improvement, without the prior written consent of the Association as provided in Article V of these Covenants; and

(v) To promptly report to the Association any defects or needed repairs for which the Association is responsible.

Section 8.2 Responsibilities of Owners - Utilities. Each Owner shall be required to pay all charges for utilities serving that Lot, including but not limited to electricity, water, gas, cable television, and telephone service, used or consumed in or on the Lot or any Improvement thereon. The utilities serving the Common Areas only shall be separately metered and paid by the Association as a Common Expense. The Association shall have authority, however, with regard to any utility, to use a common meter, pay the cost of such utilities used or consumed in the Lots, and have the costs thereof apportioned among the Lots based upon the Common Expense liability, use of the utility, or any other formula the Association may deem appropriate.

Section 8.3 Responsibilities of Association – Maintenance. The Association shall, in the discretion of the Board, without any approval of the Members being required:

(a) Maintain, install, reinstall, construct and repair all of the Improvements within the Common Areas, to include maintenance of all storm water detention facilities, and to maintain, repair and operate any other easement area shown on the Subdivision Record Map which is not under the control or management of a public utility or governmental authority;

(b) Maintain, install and replace all landscaping located within the Common Areas;

(c) Maintain and manage the Common Areas shown on the Subdivision Record Map so as to preserve the Common Areas in their improved state and prevent any unlawful or obnoxious activity, or other activity prohibited by this Declaration to be conducted thereon;

(d) Do all such other acts which the Board deems necessary to preserve and protect the Property and the beauty thereof, in accordance with the general purposes specified in this Declaration;

Section 8.4 Responsibilities of Association - Common Expenses. The following expenses are hereby declared to be Common Expenses which the Association is obligated to collect by Assessment and which Owners are obligated to pay as provided in Article VI hereof; provided, however, that the enumeration below of these expenses shall in no way limit the Association from considering other expenses incurred in managing the Association or any part of the Common Areas and/or the Property as expenses subject to collection by assessment:

(a) Maintenance and Repair of Common Areas: The cost and expense to keep and maintain the Common Areas in good repair and in a clean and attractive condition, if any, including the charges in Section 7.5 of this Declaration, as well as the following charges:

(i) Any electrical costs to run all common lighting and any other electrical device necessary to the Common Areas, including street lighting;

- (ii) Sanitary sewer and storm sewer lines within private drives, if applicable;
- (iii) Gas bills of the Association, if any;
- (iv) Water bills and sprinkler systems for use on the Common Areas;
- (v) Any insurance for the Common Areas;
- (vi) Any management fees, accounting fees, and legal expenses incurred by the Association;
- (vii) Maintenance costs of all detention ponds and storm water drainage areas, if applicable; and
- (viii) Such other matters which involve the use of the Common Areas as determined by the Association.

(b) Management. The cost and expense of such (i) employees or agents, including professional management agents, accountants and attorneys, and (ii) materials, supplies and equipment as may be needed to provide for the management, supervision and maintenance of the Common Areas.

(c) Property Taxes. All ad valorem taxes and other Assessments levied on the Common Areas, if any.

(d) Insurance. All premiums for insurance obtained by the Association and any deductibles required to be paid by the Association.

Section 8.5 Reserves. The Association may establish reserves for the payment of Common Expenses in the future.

Section 8.6 Interested Transactions. The Association may obtain materials and/or services from Developer and/or any of its Affiliates and/or any Members in connection with the management of the Association or any part of the Common Areas as herein contemplated; provided that the compensation for such materials and/or services is, in the opinion of the Association, comparable with the compensation of any non-affiliated third party providing similar materials and/or services which can be reasonably made available to the Association.

ARTICLE IX ENFORCEMENT OF PROTECTIVE COVENANTS, DEFAULTS AND REMEDIES

Section 9.1 Covenants Running with the Land. The easements, covenants, and restrictions set forth in this Declaration shall run with the Property and inure to the benefit of and be enforceable by Developer, its designated successors and assigns, the Association, or by any Owner and its respective heirs, successors and assigns, for a term of fifty (50) years from the date this Declaration is recorded, after which time the said protective covenants provided for herein shall automatically be extended for successive periods of ten (10) years, unless an agreement which

has been signed by Owners who own two-thirds or more of the then existing Lots of the Property, agreeing to terminate or modify this Declaration, has been recorded in the Probate Office.

Section 9.2 Remedies for Default. The existence of any breach or default hereunder by any person or entity subject to the terms, conditions, covenants and restrictions of this Declaration shall give Developer, its successors or assigns, any Owner, and/or their respective heirs, successors and assigns, and the Association, in addition to all other remedies specified therein, the right to proceed at law or in equity to compel compliance with the terms of this Declaration and to prevent the violation or breach of any of them; provided, this Declaration shall be recorded for the benefit of Developer, the ARC, the Association, the Owners and their respective Mortgagees, and the Occupants, and by such recording, no other adjoining property owner or third party shall have any right, title or interest whatsoever in the Property or its operation and continuation, in the enforcement of any of the provisions of this Declaration or the right to consent to or approve any amendment or modification to this Declaration.

Section 9.3 Nature of Remedies: Waiver. All rights, remedies and privileges granted to Developer, the ARC, the Association, the Owners, their respective heirs, successors and assigns, and the Occupants pursuant to the provisions of this Declaration shall be deemed to be cumulative, and the exercise of any one or more of them shall not be deemed to constitute an election of remedies, nor shall it preclude the party exercising the same, or any other party, from pursuing such other and/or additional rights, remedies or privileges as may be available to such party at law or in equity. The failure at any point in time to enforce any covenant or restriction shall in no event be deemed a waiver of the right thereafter to enforce any such covenant or restriction.

Section 9.4 Attorneys' Fees and Costs. All fees, costs and expenses, including attorneys' fees through all appellate levels, in connection with the Association's duty to enforce all of the protective covenants and other terms contained in or imposed by this Declaration, and all Rules and Regulations adopted pursuant to the Certificate of Formation, by the Bylaws or this Declaration may be assessed against the Owner in violation of this Declaration.

Section 9.5 No Reverter. No restriction or provision herein is intended to be, or shall be construed as, a condition subsequent or as creating any possibility of a reverter

ARTICLE X AMENDMENT OF DECLARATION

Section 10.1 Amendment by Association. During the Developer Control Period, this Declaration may be amended by Developer in Developer's sole discretion. Following the expiration of the Developer Control Period, an amendment to this Declaration may be proposed by the Board of Directors or by written instrument signed by the Owners of not less than one-fourth (1/4) of the Lots within the Property. Such proposed amendment or amendments shall be considered at a meeting of the Owners after written or printed notice of such meeting, stating the time and place thereof, and providing information regarding the proposed amendment or amendments in reasonably detailed form, shall be mailed to the Owners not less than ten days nor more than thirty days, before the date set for such meeting. If mailed, such notice shall be deemed to be properly given when deposited in the United States mail, addressed to each Owner at the

street address of its Lot, the postage thereon being prepaid. Any Owner may, by written waiver of notice signed by such Owner, waive such notice, and such waiver whether before or after the holding of the meeting, shall be deemed equivalent to the giving of such notice to such Owner. At such meeting, the amendment or amendments proposed must be approved by the affirmative vote of Owners who own not less than two-thirds (2/3) of the total Lots of the Property in order for such amendment or amendments to become effective. Thereupon, such amendment or amendments to the Declaration shall be transcribed and certified by the Board as having been duly adopted and the original or executed copy of such amendment or amendments so certified and executed with the same formalities as a deed shall be recorded in the Probate Office, within twenty days from the date on which the same became effective, such amendment or amendments to specifically refer to the recording identifying this Declaration. At any meeting held to consider such amendment or amendments, the written vote of any Owner shall be recognized if such Owner is not in attendance in person or by proxy at such meeting, provided such written vote is delivered to the Board at or prior to such meeting.

Section 10.2 Scrivener's Error. Notwithstanding the foregoing amendment provisions, any scrivener's error omission may be corrected by the filing of any amendment to this Declaration consented to by Developer and any Owners or Mortgagees of record directly affected by the amendment. No other Owner is required to consent to any such amendment. If there appears to be any other omissions or errors in this Declaration, scrivener's or otherwise, and such error or omission does not materially adversely affect the rights and interests of any other party, then such error or omission may be corrected by the filing of an amendment of this Declaration executed by Developer or the Association without the consent of any other party.

ARTICLE XI PERIOD OF DEVELOPER CONTROL

Section 11.1 Developer Control.

(a) Notwithstanding any provision contained herein to the contrary, until such time as Developer has sold and no longer retains ownership of any of the Lots within the Subdivision, or until the Developer elects to terminate its control of the Association, whichever is earlier (such period of time being referred to herein as the "Developer Control Period"), the Developer shall have the exclusive right to appoint and remove the members of the Board of Directors of the Association and the members of the ARC (who need not be Owners) and the right to amend the this Declaration, the Certificate of Formation, and the Bylaws of the Association.

(b) Notwithstanding the provisions of Section 11.1(a) above, no Assessments shall be imposed by the Association against the Developer as the Owner of an unsold Lot until the construction of the dwelling and other Improvements upon the Lot is completed.

(c) Developer may terminate its right to appoint the members of the Board of Directors and its other rights and obligations set forth herein, or any portion thereof, by relinquishing control of the Association in writing to the Owners at any time prior to the expiration of said Developer Control Period.

ARTICLE XII GENERAL PROVISIONS

Section 12.1 Deeds Subject to Covenant. Each deed for the sale of a Lot in the Subdivision will be subject to the terms and conditions of this Declaration regardless whether the deed contains a reference to this Declaration.

Section 12.2 Obligation of Owner to Build or Restore. In the event an Improvement on any Lot within the Property is damaged or destroyed in whole or in part, the Owner shall be obligated to repair or replace said structure within a reasonable time not to exceed one (1) year from the date of such damage or destruction and such repair or replacement of such structure shall be in accordance with the covenants and restrictions set forth in this Declaration. Further, all debris resulting from such damage or destruction must be removed and the Lot restored to a slightly condition with reasonable promptness, but not later than ninety (90) days after such damage or destruction.

Section 12.3 No Trespass. Whenever the Association, Developer, the ARC and their respective agents, employees, representatives, successors and assigns, are permitted by this Declaration to enter upon or correct, repair, clean, maintain or preserve or do any other action within any portion of a Lot or dwelling, the entering thereon and the taking of such action shall not be deemed a trespass.

Section 12.4 Notices. Any notice required to be sent to any Owner under the provisions of this Declaration shall be deemed to have been properly sent when mailed by United States mail, postage prepaid, return receipt requested, to the street address of the Lot owned by such Owner or at such other address designated by Owner in writing to the Board, except for meeting notices as provided in the Bylaws.

Section 12.5 Severability. Invalidation of any provision or provisions hereof by judgment or court order shall in no way affect any other provisions, all of which shall remain in full force and effect.

Section 12.6 Governing Law. Should any dispute or litigation arise between any of the parties whose rights or duties are affected or determined by this Declaration as the same may be amended from time to time, said dispute or litigation shall be governed by the laws of the State of Alabama.

Section 12.7 Captions. The captions and titles of the various articles and Sections in this Declaration are for convenience of reference only, and in no way define, limit or describe the scope or intent of this Declaration.

Section 12.8 Usage. Whenever used herein the singular shall include the plural and the singular, and the use of any gender shall include all genders.

Section 12.9 Conflict. If any irreconcilable conflict shall exist, or hereafter arise, with respect to the interpretation of any provisions of this Declaration, and any covenant of a Lot, then the provisions of this Declaration shall prevail.

Section 12.10 Effective Date. This Declaration shall become effective upon its recordation in the Probate Office.

[REMAINDER OF PAGE INTENTIONALLY LEFT BLANK]

IN WITNESS WHEREOF, Developer has caused this Declaration to be executed on the ____ day of _____ 2022.

DEVELOPER:

[_____],
an Alabama limited liability company

BY: _____

Print Name: _____

Its: _____

STATE OF ALABAMA)

COUNTY OF JEFFERSON)

I, _____, a Notary Public in and for said County, in said State, hereby certify that _____ whose name as _____ of _____, an Alabama limited liability company, is signed to the foregoing instrument, and who is known to me, acknowledged before me on this day that being informed of the contents of said instrument, he/she, in such capacity and with full authority, executed the same voluntarily for and as the act of said company, acting in his capacity as aforesaid.

GIVEN UNDER MY HAND AND SEAL OF OFFICE this, the __ day of _____, 2022.

Notary Public

[SEAL]

My Commission Expires: _____

The undersigned, as **MORTGAGEE** under the Mortgage encumbering the real property identified in the foregoing Declaration of Covenants, Conditions and Restrictions of [XYZ] Subdivision, joins in the execution of the foregoing Declaration of Covenants, Conditions and Restrictions of [XYZ] Subdivision for the purposes of i) consenting to the filing of the Declaration of Covenants, Conditions and Restrictions of [XYZ Subdivision] and ii) subordinating its Mortgage thereto.

MORTGAGEE:

[_____] a [_____] corporation

By: _____

Name: _____

Its _____

STATE OF ALABAMA)

COUNTY OF JEFFERSON)

I, the undersigned, a Notary Public in and for said County in said State, hereby certify that _____, whose name as _____ of _____, a _____ corporation is signed to the foregoing Declaration of Covenants, Conditions and Restrictions, and who is known to me, acknowledged before me on this day that, being informed of the contents of the Declaration of Covenants, Conditions and Restrictions, he/she, as such officer, and with full authority, executed the same voluntarily for and as the act of said corporation on the day the same bears date.

Given under my hand and seal of office this _____ day of _____, 2022.

Notary Public

[NOTARIAL SEAL]

My commission expires: _____

EXHIBIT A

LEGAL DESCRIPTION OF PROPERTY

EXHIBIT B

BYLAWS OF [XYZ] SUBDIVISION ASSOCIATION, INC.

APPENDIX F
CONDOMINIUM DECLARATION

**DECLARATION OF CONDOMINIUM
OF
[XYZ] CONDOMINIUM**

Date: _____, 20__

This instrument prepared by:

Melinda E. Sellers
Burr & Forman LLP
420 North 20th Street
Suite 3400
Birmingham, Alabama 35203

TABLE OF CONTENTS

DECLARATION OF CONDOMINIUM

[XYZ] CONDOMINIUM

Table of Contents

	Page
ARTICLE I DEFINITIONS	2
Section 1.01 Definitions.....	2
ARTICLE II PROPERTY SUBJECT TO THIS DECLARATION.....	6
Section 2.01 Description of Improvements and Identification of Units.....	6
Section 2.02 Amendment of Condominium Plan.....	6
Section 2.03 Easements and Restrictions	6
Section 2.04 Ownership of Common Elements	8
Section 2.05 Rights in or to Limited Common Elements.....	9
ARTICLE III DEVELOPMENT RIGHTS TO ADD ADDITIONAL PROPERTY TO THE CONDOMINIUM.....	9
Section 3.01 Reservation of Development Rights.....	9
Section 3.02 Exercise of Development Rights.....	10
Section 3.03 Expiration of Development Rights.....	10
Section 3.04 Improvements on Additional Property	10
Section 3.05 Reallocations and Amendment.....	11
ARTICLE IV ORGANIZATION AND MANAGEMENT OF THE ASSOCIATION.....	11
Section 4.01 Management of the Condominium Property	11
Section 4.02 Members.....	11
Section 4.03 Bylaws.....	12
Section 4.04 Voting Requirements.....	12
Section 4.05 Master Association	12
ARTICLE V ASSESSMENTS	12
Section 5.01 Liability, Lien and Enforcement	12
Section 5.02 Assessments.....	12
Section 5.03 Annual Budget.....	13
Section 5.04 Omission of Assessment	13
Section 5.05 Detailed Records	14
Section 5.06 Payment of Common Expenses and Limited Common Expenses by Unit Owners	14
Section 5.07 Default in Payment of Assessments	14
Section 5.08 Required Reserve Funds.....	15
Section 5.09 Election of Remedies.....	15

ARTICLE VI MAINTENANCE AND OPERATION OF THE CONDOMINIUM PROPERTY	15
Section 6.01 The Association's Obligation to Repair.....	15
Section 6.02 Each Owner's Obligation to Repair.....	16
Section 6.03 Maintenance of Limited Common Elements.....	18
Section 6.04 Alterations, Additions and Improvements by the Association.....	19
Section 6.05 Utilities and Services.....	19
ARTICLE VII RESTRICTIONS ON USE OF UNITS, COMMON ELEMENTS	20
Section 7.01 Rules and Regulations of the Association.....	20
Section 7.02 Restrictions on Use.....	20
Section 7.03 Lease of Units.....	22
Section 7.04 Right of Access	23
Section 7.05 Limitation of Liability.....	23
Section 7.06 Abatement of Violations	24
Section 7.07 Failure of the Association to Insist on Strict Performance; No Waiver	24
ARTICLE VIII RIGHTS OF MORTGAGEES	24
Section 8.01 Notification of Mortgagees Required.....	24
Section 8.02 Right of Inspection	24
Section 8.03 Priority of Mortgagees.....	25
Section 8.04 Request for Protection by Mortgagees	25
ARTICLE IX CASUALTY LOSS AND INSURANCE.....	26
Section 9.01 Responsibility of Owners; Separate Insurance Coverage.	26
Section 9.02 Insurance to be Maintained by the Association.....	26
Section 9.03 Governing Provisions	28
Section 9.04 Premiums and Deductibles	29
Section 9.05 Insurance Trustee.	29
Section 9.06 Loss to Common Elements Only.....	30
Section 9.07 Loss to Common Elements, Limited Common Elements and/or Units	30
Section 9.08 Estimates of Repair; Plans and Specifications; Payment of Assessments.....	31
ARTICLE X CONDEMNATION	32
Section 10.01 Condemnation Considered a Casualty Loss.....	32
Section 10.02 Partial Condemnation	32
Section 10.03 Association Appointed As Attorney-In-Fact for Unit Owners	34
ARTICLE XI TERMINATION.....	34
Section 11.01 Termination by Consent	34
Section 11.02 The Association Appointed as Attorney-In-Fact for Unit Owners	34
ARTICLE XII CONTROL OF THE ASSOCIATION.....	34
Section 12.01 Election of Board of Directors	34
Section 12.02 Notice of Meeting.....	35
Section 12.03 Status of Unsold Units.....	35

Section 12.04 Professional Management and Other Contracts36

ARTICLE XIII AMENDMENT.....36

Section 13.01 Amendment36

Section 13.02 Effectiveness of Amendments.....37

ARTICLE XIV DISPUTE RESOLUTION37

Section 14.01 Agreement to Resolve Disputes Without Litigation.37

Section 14.02 Dispute Resolution Procedures.38

Section 14.03 Initiation of Litigation by Association.40

ARTICLE XV MISCELLANEOUS.....41

Section 15.01 Rights and Powers of Successors and Assignees41

Section 15.02 Headings41

Section 15.03 Mold and Mildew; Potential for Water Intrusion41

Section 15.04 Gender/Number41

Section 15.05 Exhibits.....41

Section 15.06 Invalidity and Severability41

Section 15.07 Interpretation41

EXHIBITS

Exhibit "A" Legal Description of Property

Exhibit "B" Additional Property

Exhibit "C" Bylaws of the Association

Exhibit "D" Plat and Plan of the Condominium

Exhibit "E" Allocated Interests, Limited Common Elements Assignments and Votes

Exhibit "F" Allocated Interests upon Addition of Additional Property

Exhibit "G" Easements and Restrictions of Record

**DECLARATION OF CONDOMINIUM
OF
[XYZ] CONDOMINIUM**

THIS DECLARATION is made this ____ day of _____ 20__, by [_____] (the "Developer"), pursuant to the provisions of the Alabama Uniform Condominium Act of 1991, CODE OF ALABAMA 1975 §§ 35-8A-101 *et seq.* (the "Act"), for the purpose of forming a condominium and establishing certain easements, covenants and restrictions to run with the land:

W I T N E S E T H:

WHEREAS, Developer is the owner of certain real property located in the City of Mountain Brook, Jefferson County, Alabama, more particularly described on Exhibit "A" attached hereto on which is located ____ (__) building, containing ____ (__) levels with ____ (__) Units on each level. The entire Condominium initially shall contain _____ (__) Units and certain other improvements in accordance with the Plan (as defined below) a copy of which is included in Exhibit "D" attached to this Declaration (the "Property" or "Condominium Property");

WHEREAS, the Developer reserves the right to (i) add Additional Property (hereinafter defined) to the Condominium, (ii) create additional Units and Common Elements in the Condominium, (iii) construct patios, terraces, rooftop amenities, boat slips, and other recreational amenities within the Condominium Property and/or the Additional Property, subject to the terms and conditions set forth herein; and

WHEREAS, it is the desire and intent of the Developer, by recording this Declaration, to establish a condominium (as defined in the Act) to be known as [XYZ] Condominium under the provisions of the Act and to impose upon the Property mutually beneficial restrictions under a general plan for the benefit of all of the Condominium Units contained therein and the Owners thereof.

NOW, THEREFORE, Developer, upon recording hereof, does submit the Property to the provisions of the Alabama Uniform Condominium Act of 1991 to be held, conveyed, hypothecated, encumbered, leased, used, occupied, improved and in any other manner utilized subject to the provisions of said Act and subject to the covenants, conditions, restrictions, uses, limitations and affirmative obligations set forth in this Declaration, all of which are declared and agreed to be in furtherance of a plan for the improvement of said property and the division thereof into condominium ownership and all of which shall run with the land and shall be binding on all parties (including Owners as hereinafter defined) having or acquiring any right, title or interest in the Property or any part thereof, and shall be for the benefit of each Owner of any portion of the Property or any interest therein, and shall inure to the benefit of and be binding upon each successor in interest to the Owners thereof.

ARTICLE I

DEFINITIONS

Section 1.01 Definitions Initially capitalized terms as used in this Declaration shall be defined as follows, unless the context clearly indicates a different meaning therefore:

(a) **"Act"** shall mean the Alabama Uniform Condominium Act of 1991, CODE OF ALABAMA §§ 35-8A-101 *et seq.*, as the same may be amended from time to time.

(b) **"Additional Property"** shall mean all or any portion of the real property described on Exhibit "B" attached hereto and the improvements now or hereafter constructed thereon including Units and Common Elements, which property may be submitted in whole or in part in one or more phases to the Condominium, in Developer's sole discretion.

(c) **"Association"** shall mean [XYZ] Condominium Association, Inc., a nonprofit corporation organized pursuant to the Alabama Nonprofit Corporation Law, CODE OF ALABAMA §§ 10A-1-1.01 *et seq.*, of which all Owners shall be members and which corporation shall administer the operation, management, maintenance, and administration of the Condominium Property.

(d) **"Board of Directors"** or **"Board"** shall mean the Board of Directors of the Association, appointed or elected pursuant to the Bylaws of the Association.

(e) **"Bylaws"** shall mean the set of Bylaws, a copy of which is attached hereto as Exhibit "C", recorded simultaneously with this Declaration.

(f) **"Certificate of Formation"** shall mean the Certificate of Formation of the Association recorded as Entity No. _____ in the Office of the Secretary of State of the State of Alabama, on _____, 20__, as said Certificate may be amended from time to time.

(g) **"Common Elements"** shall mean and include the following:

(i) The Land;

(ii) The foundations and footings, bearing walls, perimeter walls, structural slabs, columns, beams and supports;

(iii) The balconies, roof, hallways, elevator, mechanical equipment, garbage, and storage areas designated as Common Elements on the Plat or for common use, stairways and entrances and exits or communication ways, some of which may be designated as Limited Common Elements;

(iv) The compartments or installations of central services such as central air conditioning, ventilation, heating, power, light, electricity, fire protection,

security, cold and hot water, plumbing, reservoirs, water tanks and pumps, sewer lines, flues, and the like, and all similar devices and installations existing for common use, but excluding all compartments or installations of utilities and services which exist for private use in the Units;

(v) The premises and facilities, if any, used for the maintenance or repair of the Property;

(vi) The grounds, courtyard, landscaping, sidewalks and central mail boxes;

(vii) All easements, rights or appurtenances affecting or relating to the use of the Condominium Property; and

(viii) All other elements (other than the Units) desirable or rationally of common use or necessary to the existence, upkeep and safety of the Condominium Property.

(h) **"Common Expenses"** shall mean the expenses arising out of the ownership of the Common Elements for which the Owners are liable to the Association and shall include, but not be limited to, expenses of administration of the Condominium Property; expenses of insurance; expenses of maintenance, operation, repair, replacement, rehabilitation, restoration, renovation and betterment of the Common Elements and any portion of a Unit maintained by the Association; any valid charge against the Condominium Property as a whole; a proportionate share of all Master Association Expenses; and expenses declared to be Common Expenses by the provisions of the Condominium Documents, as the same may be amended, from time to time, in accordance with the provisions thereof.

(i) **"Common Surplus"** shall mean the excess of all the receipts of the Association including, but not limited to, assessments, rents, profits and revenues over the amount of the Common Expenses.

(j) **"Condominium Documents"** shall mean this Declaration of Condominium and all Exhibits hereto, the Bylaws, the Certificate of Formation of the Association, as the same shall be amended from time to time and the Rules and Regulations of the Association.

(k) **"Declaration of Condominium"** or **"Declaration"** shall mean this instrument and all Exhibits hereto as it, from time to time, may be amended.

(l) **"Developer"** or **"Declarant"** shall mean [XYZ] DEVELOPMENT, LLC, an Alabama limited liability company, or such other person, who shall receive by assignment from the said Developer all, or a portion of its rights hereunder as such Developer, by an instrument expressly assigning such rights as Developer to such assignee.

(m) **"Land"** shall mean the parcel or tract of real estate described in Exhibit "A" to this Declaration, submitted to the provisions of the Act.

(n) **"Limited Common Elements"** shall mean and include any area designated as Limited Common Elements on the Plan and any amendment to the Plan and any areas defined in the Act as Limited Common Elements including parking spaces and storage units. The Limited Common Elements shall include among any other property so designated, the balconies, patios, and terraces, elevators, the chutes, flues, wires, conduit, bearing walls, bearing columns or any other fixture serving only that Unit. Should any Limited Common Element ever be determined not to be a Limited Common Element under the Act, the same shall be part of the Common Elements with an exclusive easement of use appurtenant to the Unit to which it was originally assigned as a Limited Common Element.

(o) **"Limited Common Expenses"** shall mean the expenses arising from the maintenance or repair of the Limited Common Elements for which the Unit Owners to which the Limited Common Elements are appurtenant shall be liable to the Association. Limited Common Expenses may include, but not be limited to, the expenses of maintenance, operation, repair, replacement, rehabilitation, restoration, renovation, and betterment of the Limited Common Elements; and expenses declared to be Limited Common Expenses by the provisions of the Condominium Documents, as the same may be amended, from time to time, in accordance with the provisions thereof.

(p) **"Master Association"** shall mean the [XYZ] Subdivision Association, Inc., an Alabama nonprofit corporation created by filing the Certificate of Formation of the [XYZ] Subdivision Association, Inc. in the Office of the Secretary of State of the State of Alabama with File Number _____.

(q) **"Master Common Areas"** shall mean those areas designated as [_____] as shown on the [XYZ] Condominiums Final Plat recorded in the Probate Office in Map Book _____, Page __ and all improvements as have been or may be constructed thereon including [_____].

(r) **"Mortgage"** shall mean a first lien Mortgage on one or more Units.

(s) **"Mortgagee"** shall mean a holder of a Mortgage who has given notice to the Association that it is the holder of a first Mortgage encumbering a Unit and has provided an address for written notices.

(t) **"Occupant"** shall mean a person or persons in possession of a Unit including family members, tenants, invitees or guests, regardless of whether that person is the Unit Owner. Each Unit Owner shall be responsible for the acts or omissions of any Occupant of such Owner's Unit.

(u) **"Owner"** or **"Unit Owner"** shall mean and refer to every person or entity who is an owner of a Unit.

(v) **"Plan"** or **"Plat"** shall mean the plat and plans showing the Units, the Common Elements and the Limited Common Elements of the Condominium Property attached hereto as Exhibit "D" and recorded in Instrument Number _____ in the Probate Office, and made a part hereof for all purposes, as such Plan may from time to time be amended.

(w) **"Probate Office"** shall mean the Office of the Judge of Probate of Jefferson County, Alabama.

(x) **"Property"** or **"Condominium Property"** shall mean the Land and all improvements and structures erected, constructed or contained therein or thereon, including the building, and all easements, rights and appurtenances belonging thereto, and all furniture, furnishings, fixtures and equipment intended for the mutual use, benefit or enjoyment of the Owners, submitted to the provisions of the Act under this Declaration, as amended from time to time.

(y) **"Rules and Regulations"** shall mean those Rules and Regulations adopted from time to time by the Board of Directors of the Association that are deemed necessary for the enjoyment of the Condominium Property, provided they are not in conflict with the Act or the Condominium Documents.

(z) **"Unit"** or **"Condominium Unit"** shall mean the parts of the Condominium Property as set forth in the Plan intended for the exclusive ownership and possession by a Unit Owner. The Unit is identified in a diagrammatic floor plan of the floor on which the Unit is situated as shown on the Plan and shall consist of the volumes or cubicles of space which lie between the lower, upper and lateral or perimetrical boundaries described as follows:

(i) *Upper and Lower Boundaries:* The upper and lower boundaries extended to their planer intersections with the perimetrical boundaries as follows:

(A) The upper boundary shall be the horizontal plane of the lower unpainted surface of the material which constitutes the ceiling or the plane of the lower surface of any exposed beam or joist that is a part of the ceiling;

(B) The lower boundary shall be the horizontal plane of the upper unpainted or unfinished surface of the material which serves as the Unit's floor. Any floor covering such as subflooring, painting, carpeting, finishing, hardwood or ceramic tile is part of the Unit.

(ii) *Perimetrical Boundaries:* The perimetrical boundaries shall be the vertical planes of the exterior surfaces of the exterior windows and exterior doors, and the interior unpainted surfaces of the material which forms the perimeter wall of the Unit. All sheetrock, wall boards, including paint, wallpaper and light coverings, extended to their planer intersections with each other and with the upper and lower boundaries are part of the Unit.

Each Unit shall include all non-structural interior partition walls located within the boundaries of the Unit except such part as may comprise part of the Common Elements; the decorated surfaces of all boundary walls, ceilings and floors, including wallpaper, paint, interior brick surface, lathe, wallboard, plaster, carpeting, flooring and other finishing materials; all immediately visible fixtures, appliances, cabinets, and water and sewer pipes located within the boundaries of the Unit and serving only the Unit; and the mechanical systems and installations providing electrical power, gas, water, heating and air conditioning service to the Unit, including the individual compressor or meter even though such equipment may be located outside the boundaries of the Unit, provided that no pipes, wires, conduits, ducts, flues, shafts and other facilities situated within such Unit and forming a part of any system serving one or more other Units or the Common Elements shall be deemed to be a part of such Unit; and provided further that no bearing wall, joist, or beam providing structural support and located within the boundaries of the Unit shall be deemed part of the Unit.

ARTICLE II

PROPERTY SUBJECT TO THIS DECLARATION

Section 2.01 Description of Improvements and Identification of Units. The Condominium Property shall initially consist of ____ () building containing ____ () levels with ____ () Units on each level; the total building containing _____ () Units. A plat of the Land and improvements thereon and a graphic description of the improvements in which the Units are located, identifying each Unit by a number and/or letter so that no Unit bears the same designation as any other Unit, all in sufficient detail to identify the Common Elements, the Limited Common Elements and each Unit and their relative locations and approximate dimensions, are set forth in the Plan attached hereto as Exhibit “D”. There is no obligation to submit any Additional Property or additional phases to the Condominium.

Section 2.02 Amendment of Condominium Plan. Developer reserves the right to change the interior design and arrangement of any Unit, to alter the boundaries between Units and to increase or decrease the number of Units so long as the Developer owns the Units so altered. Developer reserves the right to create additional Units and Limited Common Elements from the Common Elements. Also, Developer reserves to itself or any subsequent Owner the right to combine two or more Units or to subdivide any of the Units into as many Units as Developer or the Unit Owner determines, in its sole discretion, which number shall not exceed _____ () Units. Upon subdivision of any Unit, the allocated interests assigned to the Unit subdivided shall be allocated to the resulting Units as determined by the Developer or such affected Unit Owner but which total allocated interests shall not exceed the amount originally assigned to the single Unit. Changes in the boundaries between the Units, as hereinbefore provided, shall be reflected by an amendment to the Plan, and if necessary, an amendment to this Declaration. An amendment to the Plan or the Declaration reflecting an alteration of the boundaries of the Units or addition of Units need be signed and acknowledged only by the Developer or affected Unit Owner and need not be approved by the other Owners and Mortgagees, whether or not such approval may elsewhere be required herein.

Section 2.03 Easements and Restrictions. The Units, Common Elements and Limited Common Elements shall be, and the same are hereby declared to be subject to the

restrictions, easements, conditions and covenants prescribed and established in the Condominium Documents governing the use of said Units, Common Elements and Limited Common Elements in setting forth the obligations and responsibilities incident to ownership of each Unit and its appurtenant undivided interest in the Common Elements. The Units, Common Elements and Limited Common Elements are further declared to be subject to the restrictions, easements, conditions and limitations now of record affecting the Condominium Property, which easements and restrictions are described on Exhibit "G" attached hereto. Additional easements established hereunder include the following:

(a) Utility Easements. Utility easements are reserved throughout the whole of the Property, including Units, as may be required for utility services (including, without limitation, water, sewer, gas, electricity, telephone, internet and cable television) in order to adequately serve the Condominium Property.

(b) Utility Equipment. There may be utility equipment which is appurtenant to the Units, but which is located on the Common Elements. An easement is hereby reserved in favor of each Unit for the purpose of placement, maintenance, repair and replacement of said utility equipment by Developer and the Owners of the Unit; provided that no utility equipment shall be placed on any part of the Common Elements or Limited Common Elements other than the present location unless the written approval of the Association shall have been first obtained.

(c) Easements for Ingress and Egress. The Common Elements shall be, and the same are hereby declared to be subject to a perpetual nonexclusive easement of way over all walkways, halls, stairways, and other common areas in favor of all Owners for all proper and normal purposes and for the furnishing of services and facilities for which the same are reasonably intended for the enjoyment of said Owners, subject to all restrictions in the Condominium Documents.

(d) Easement for Use of Leased or Acquired Property. Each Unit Owner shall have a nonexclusive easement for use of any property hereafter acquired by the Association for the common benefit of the Owners by purchase, lease or otherwise for all normal and proper purposes for which the same are reasonably intended, subject to all restrictions in the Condominium Documents and the Rules and Regulations.

(e) Easements for Encroachments. To the extent that any Unit, Common Element or Limited Common Element encroaches on any other Unit, Common Element, or Limited Common Element, whether by reason of any deviation from the Plan in the original construction, repair, renovation, restoration or replacement of any improvement, or by reason of the settling or shifting of any land or improvement, a valid easement shall exist for the encroachment and/or the maintenance of the same, so long as the encroaching Unit, Common Element or Limited Common Element stands. This easement, however, shall not relieve an Owner of liability for his or his agent's negligence, intentional acts or willful and intentional misconduct in causing the encroachment. In the event any Unit, any adjoining Unit, or any adjoining Common Elements or Limited Common Elements shall be partially or totally destroyed as a result of fire or other casualty or as a result of

condemnation or eminent domain proceedings, and then constructed, reconstructed or repaired, encroachment of parts of the Common Elements or Limited Common Elements upon any Unit, or encroachment of any Unit upon any other Units, Common Elements or Limited Common Elements resulting from such construction, reconstruction or repair shall be permitted, and valid easements for such encroachment and the maintenance thereof shall exist so long as the encroaching improvements shall stand.

(f) Easement for Services and Emergencies. There shall be nonexclusive easements for all police, firemen, ambulance operators, mail carriers, delivery services, garbage service workers, and all similar persons, and the Association, but not the public in general, to enter upon the Common Elements in the performance of their duties, subject to reasonable rules and regulations as the Board may establish from time to time.

(g) Easement of Support. Each Unit and the Common Elements and Limited Common Elements shall have an easement of support from every other Unit, Common Elements or Limited Common Elements which provide such support.

(h) Easement for Use of Limited Common Elements. Each Owner shall have an easement for the use and upkeep of the Limited Common Elements appurtenant to his Unit and for ingress and egress to and from the Limited Common Elements for so long as the Limited Common Elements exist. The aforesaid easement shall be for the benefit of each Unit Owner to which the Limited Common Element is appurtenant.

(i) Easements Appurtenant to Units. The easements and other rights created herein for the Unit Owners shall be appurtenant to the Unit of that Owner and all conveyances of title to the Unit shall include a conveyance of the easements and rights as are herein provided even though no specific reference to such easements and rights appear in such instrument. The Owners do hereby designate the Developer and/or the Association as their lawful attorney-in-fact to execute any and all instruments on their behalf for the purpose of creating all such easements as are contemplated by the provisions hereof.

(j) Easements in Favor of Additional Property. There shall be a perpetual non-exclusive easement for vehicular and pedestrian ingress and egress over the Common Elements of the Property for the benefit of the Developer and the owners of the Additional Property for all purposes incident to the development of the Additional Property. Further, there shall be a perpetual, non-exclusive easement for the benefit of the Developer and the owners of the Additional Property for the maintenance and use of all sewage disposal, storm drainage and utility distribution systems and facilities as are presently located on the Property, and for the maintenance and use of such sewage disposal, storm drainage and utility distribution systems and facilities as may be constructed or installed on the Property in the future.

Section 2.04 Ownership of Common Elements. Each Owner shall own an undivided interest in the Common Elements with all other Owners, and, except as otherwise limited in this Declaration, shall have the right to use the Common Elements for all purposes incident to the use and occupancy of the Unit as herein provided, without hindering or encroaching upon the lawful rights of the other Owners, which rights shall be appurtenant to and run along with

the Units. The extent or amount of such ownership shall be expressed by a percentage relating to each Unit and shall remain constant, unless changed in accordance with the provisions of Section 2.02 or Article III hereof or by the unanimous approval of all Owners and Mortgagees affected hereby. The percentage ownership in the Common Elements relating to each Unit is set forth on Exhibit "E" attached hereto.

Section 2.05 Rights in or to Limited Common Elements.

(a) The Limited Common Elements appurtenant to the Unit shall be as described by the Act, as shown on the Plan, a copy of which is attached as Exhibit "D," and/or as set forth in the chart attached hereto as Exhibit "E." The description shall be expressed by identifying the type of Limited Common Elements which are appurtenant to the Unit, if any, and the Owners of such Units shall have the exclusive right to use such Limited Common Elements so designated or described unless changed by the Developer as permitted in Section 2.02 or Article III hereof or by the unanimous approval of the Owners of the Units to which Limited Common Elements are appurtenant and their respective Mortgagees. Each Owner of a Unit to which the Limited Common Element is appurtenant shall have the right to use the Limited Common Element for all purposes incident to the use and occupancy of his Unit as herein provided without hindering or encroaching upon the lawful rights of the other Owners, which rights shall be appurtenant to and run along with the Units to which the Limited Common Elements are attached.

(b) The hallways on each level of the building are Limited Common Elements appurtenant to the Units located on that level.

ARTICLE III

**DEVELOPMENT RIGHTS TO ADD
ADDITIONAL PROPERTY TO THE CONDOMINIUM**

Section 3.01 Reservation of Development Rights. Developer reserves the right, but has no obligation, to add all or any portion of the Additional Property described on Exhibit "B" attached hereto, together with any improvements constructed thereon, which may eventually consist of as many as _____ () additional Units, Common Elements and Limited Common Elements (including boat slips) to the Condominium Property within ten (10) years from the conveyance of the first Unit in the Condominium, in one or more additional phases; the total condominium shall never contain more than _____ () Units. Any future phase of the Condominium may include recreational facilities as well as additional Units, Common Elements and/or Limited Common Elements. Developer also reserves the right to designate portions of Common Elements in the initial Condominium as Limited Common Elements to initial Condominium Units should it develop the Additional Property. For example, the Common Elements of the building in the initial Condominium could be designated as Limited Common Elements for the exclusive use of the Unit Owners in that building rather than in the future phases. The style and size of any additional building added to the Condominium shall be within Developer's sole discretion. Any additional improvements to be constructed on any portion of the Additional Property that is submitted to the Condominium shall be of substantially the same

quality as the currently existing improvements in the Condominium. The submission of the Additional Property may be accomplished in one or more phases within the ten (10) year period, by filing an amendment to this Declaration and the Plat and Plans, which amendment(s) only need to be signed by the Developer and the Developer's Mortgagee, if any. If all or any portion of the Additional Property is later submitted to the condominium form of ownership by amendment to this Declaration, the Additional Property may only be added if developed in conjunction with the allocation of percentage ownership of the Common Elements, the sharing of Common Expenses, and the allocation of voting rights as set forth on Exhibit "F" attached hereto. Nothing contained herein shall obligate the Developer to submit the Additional Property to the Condominium; however, the Developer may submit all, part or none of the Additional Property to the Condominium. Prior to being added to the Condominium, if so added, no portion of the Additional Property shall be subject to this Declaration. If any portion of the Additional Property is added to the Condominium, only such portion added shall be subject to this Declaration. Any part of the Additional Property not submitted to the Condominium may be developed or used by the Developer in any manner it deems proper, including the development of another mixed-use project.

Section 3.02 Exercise of Development Rights. Except as otherwise specifically set forth in this Declaration, there shall be no limitations on the development right to add any portion of the Additional Property, Units, Common Elements, and/or Limited Common Elements to the Condominium or the exercise thereof. The right may be exercised to add all or any portion of the Additional Property to the Condominium at one time or at different times, or the right may not be exercised at all, in Developer's sole discretion. There shall be no limitations to the boundaries of any portion of the Additional Property added to the Condominium. The exercise of the right to add a portion of the Additional Property, which may contain Units, Common Elements and/or Limited Common Elements to the Condominium shall not prohibit Developer from, or obligate Developer to, further exercise of the right as to any other portion of the Additional Property.

Section 3.03 Expiration of Development Rights. The development rights set forth herein, specifically including the right to submit all or any portion of the Additional Property to the Condominium may be exercised by Developer at any time and from time to time for a period of ten (10) years from the date of recording this Declaration in the Probate Office. Upon the expiration of said ten (10) year period, to the extent not exercised or previously terminated by Developer by express amendment to this Declaration, the right shall expire and terminate; provided, however, that Developer may extend said period for the exercise of the development rights with the consent of the Unit Owners of Units to which two-thirds (2/3) of the votes in the Association appertain within one (1) year prior to the date upon which the development rights would otherwise have expired.

Section 3.04 Improvements on Additional Property. Any and all structures erected on any portion of the Additional Property or improvements to the Additional Property if added to the Condominium will be compatible with the structures on the Property in terms of physical appearance, structure, type, quality of construction, and architectural style. The maximum number of Units that ever may be in the Condominium is seventy-five (75) Units. There are no limitations as to the particular location or type of any improvements that may be made on any portion of the Additional Property added to the Condominium. Developer shall have the right,

but not the obligation, to construct such improvements on the Additional Property, or any portion thereof added to the Condominium as Developer shall deem advisable for the common use and enjoyment of the Unit Owners, including limited common element boat slips. No limitations are placed on the right of Developer reserved hereby to create Limited Common Elements within any portion of the Additional Property or to designate Common Elements therein which may subsequently be assigned as Limited Common Elements. Except as expressly provided in this Section, there are no assurances that any Units created on any portion of the Additional Property added to the Condominium will be substantially identical to the Units submitted with this Declaration and there are no assurance as to what types of Units may be created on the Additional Property. All improvements on the Additional Property will be substantially completed in accordance with the Act prior to being added to the Condominium.

Section 3.05 Reallocations and Amendment. Upon the addition of any portion of the Additional Property containing Units to the Condominium, the share of undivided interest in the Common Elements and the share of liability for Common Expenses and Limited Common Expenses allocable to all Units then included in the Condominium shall be reallocated in accordance with the formula set forth on Exhibit "F," subject to the right of Developer to make adjustments based upon the number of additional Units added, so that the total of all interests equals 100%. Each Unit located upon any portion of the Additional Property added to the Condominium shall be allocated the number of votes in the Association as are comparable to the votes allocated to the existing Units of comparable size in the Condominium. Notwithstanding anything contained in this Declaration to the contrary, to add all or a portion of the Additional Property to the Condominium, Developer (and its lender, if any) alone shall execute and record an amendment to this Declaration and the Plan, submitting such portion of the Additional Property to the Act and this Declaration and reallocating the undivided interests in the Common Elements, the liabilities for Common Expenses and the votes in the Association.

ARTICLE IV

ORGANIZATION AND MANAGEMENT OF THE ASSOCIATION

Section 4.01 Management of the Condominium Property. Operation and administration of the Condominium Property shall be performed by the Association. The powers and duties of the Association shall include those set forth in the Act, the Alabama Nonprofit Corporations Act, CODE OF ALABAMA 1975 §§ 10A-1-1.01 *et seq.*, this Declaration, the Certificate of Formation and the Bylaws of the Association.

Section 4.02 Members. The members of the Association shall consist of all record Unit Owners. Change of membership in the Association shall be established by recording in the public records of Jefferson County, Alabama, the deed or other instrument establishing record title to a Unit in the Condominium Property, the Owner designated by such instrument thereby becoming a record Owner and a member of the Association. Membership of the prior Owner shall thereby be terminated. All present and future Owners and Occupants of the Units shall be subject to and shall comply with the provisions of the Declaration, the Bylaws and the Rules and Regulations, as the same may be amended from time to time. The votes for a Unit shall be cast by the record Owner thereof or the duly authorized proxy of the record Owner in the manner

provided in the Bylaws. Each Unit Owner is entitled to the number of votes for each Unit owned by him as set forth in Exhibit “E” attached hereto.

Section 4.03 Bylaws. The Bylaws of the Association shall be in the form attached as Exhibit “C” to this Declaration, and may be amended from time to time as set forth therein.

Section 4.04 Voting Requirements. Unless a specific voting requirement in excess of a simple majority is required by this Declaration or the Bylaws for either a vote of the Board of Directors or a vote of members, any such voting requirements shall be construed to require only a simple majority vote.

Section 4.05 Master Association. The Owners will be required to pay a pro rata share of Master Association Expenses. Each Unit Owner shall be a member of the Master Association.

ARTICLE V

ASSESSMENTS

Section 5.01 Liability, Lien and Enforcement. The Association is given the authority to administer the operation and the management of the Condominium Property, it being recognized that the delegation of such duties to one entity is in the best interest of the Owners of all Units. To provide the funds necessary for such proper operation, the Association is hereby granted the right to make, levy, and collect annual assessments against the Owners of all Units to pay Common Expenses and such other expenses which the Association is authorized to incur under the terms and conditions of this Declaration. The Association is also authorized to make, collect and levy assessments against Unit Owners for reimbursement of expenses the Association is caused to incur by reason of any act of the Unit Owner, his family members, guests, invitees or tenants for damages of any nature and for fines for rules violations. In furtherance of said grant of authority to the Association to make, levy and collect assessments to pay the costs and expenses for the operation and management of the Condominium Property and said fines, the following provisions in this Article V shall be effective and binding upon the Owners of all Units.

Section 5.02 Assessments.

(a) All assessments for the payment of Common Expenses shall be levied annually against the Owners of all Units, and unless specifically otherwise provided for in this Declaration, each Owner of a Unit and his Unit shall bear the same percentage share of such assessment as the percentage share of ownership for the undivided interest in the Common Elements appurtenant to said Unit. The Association may include the common expense assessments levied against the Units by the Master Association as a part of the Common Expenses. The assessments for Common Expenses shall be payable over the course of the year in advance monthly installments commencing on the date of purchase of a Unit or in such other installments and at such times as may be determined by the Board of Directors of the Association.

(b) Assessments for the payment of Limited Common Expenses may be levied against the Owners of those Units to which the Limited Common Elements are appurtenant if the Board of Directors determines that it is the most equitable method of assessment for Limited Common Expenses. The Limited Common Expenses may also be included in Common Expenses and assessed in the same proportion as Common Expenses if the Board of Directors chooses this method of assessment. The assessments for Limited Common Expenses, if any, shall be payable in such installments and at such times as may be determined by the Board of Directors of the Association.

(c) The Association may assess the Owners of Units for the repair and maintenance of various components of the Common Elements or Limited Common Elements based on the usage of any component of the Common Elements or Limited Common Elements. Such assessments shall not be included in the assessment for Common Expenses, but shall be payable in such manner and at such times as may be determined by the Board of Directors of the Association.

Section 5.03 Annual Budget. Within sixty (60) days prior to the beginning of each calendar year, the Board of Directors of the Association shall adopt a proposed annual budget for such calendar year, and such budget shall project the amount of funds for the forthcoming year which may be required for the proper operation, management and maintenance of the Condominium Property, including reasonable allowances for contingencies and reserves therefore, in accordance with the Act and this Declaration. Said budget shall take into account any projected anticipated income which is to be applied in reduction of the amounts required to be collected as an assessment each year. Within thirty (30) days after adoption of such annual budget by the Board of Directors of the Association, copies of said budget shall be made available to each Unit Owner and the Board shall set a date for a meeting of the Unit Owners to consider ratification of the budget not less than ten (10) nor more than thirty (30) days after delivery of the budget to the Unit Owners. Unless at the meeting a majority of the Unit Owners present in person or by proxy reject the budget, the budget is ratified, whether or not a quorum is present. In the event the proposed budget is rejected the budget for the last year shall continue in effect until such time as a new budget is ratified. If the budget is ratified the assessments for said year shall be established based upon such budget.

Should the Board of Directors at any time determine in the sole discretion of said Board of Directors that the assessments levied are or may prove to be insufficient for any reason including emergencies and non-payment of any Owner's assessment, the Board of Directors shall have authority to levy such additional assessments as it shall deem necessary in accordance with the applicable provisions of the Condominium Documents and the Act.

Section 5.04 Omission of Assessment. The omission by the Association, before the expiration of any year, to fix the assessments for that or the next year shall not be deemed a waiver or modification in any respect of the provisions of this Declaration, or a release of any Owner from the obligation to pay assessments or any installment thereof for that or any subsequent year, but the assessment fixed for the preceding year shall continue until a new assessment is fixed.

Section 5.05 Detailed Records. The Association shall keep detailed, accurate records in chronological order of the receipts and expenditures and any other expenses incurred. Records and vouchers authorizing the payments involved shall be available for examination by any Owner or his representative at convenient hours of weekdays in the county where the Condominium is located.

Section 5.06 Payment of Common Expenses and Limited Common Expenses by Unit Owners. All Unit Owners shall be obligated to pay any assessment for Common Expenses and Limited Common Expenses adopted by the Board of Directors pursuant to the terms of this Article V. No Unit Owner may exempt himself from liability for his contribution toward Common Expenses or Limited Common Expenses by waiver of the use or enjoyment of any of the Common Elements, Limited Common Elements or by abandonment of his Unit. No Unit Owner shall be liable for the payment of any part of the Common Expenses or Limited Common Expenses assessed against his Unit subsequent to a sale or other conveyance by him of such Unit. The purchaser of a Unit shall be jointly and severally liable with the selling Unit Owner for all unpaid assessments against the latter up to the time of conveyance without prejudice to the purchaser's right to recover from the selling Unit Owner the amounts paid by the purchaser therefore. Whenever any Unit may be sold or mortgaged by the Owner thereof, which sale shall be concluded only upon compliance with the other provisions of this Declaration, the Association, upon written request of the Owner of such Unit, shall furnish to the Owner (within the time period prescribed by the Act) a statement verifying the status of the payment of any assessment which shall be due and payable to the Association by the Owner of such Unit and the other information required by the Act. Any purchaser or proposed Mortgagee may rely upon such statement in concluding the proposed lease, purchase or mortgage transaction and the Association shall be bound by such statement. In the event that a Unit is to be sold or mortgaged when any assessment is outstanding against the Owner of such Unit and such assessment due the Association is in default, the purchase or mortgage proceeds shall first be paid by purchaser or Mortgagee to the payment of any delinquent assessment or installment due the Association before the payment of the proceeds to or on behalf of the selling Unit Owner.

Section 5.07 Default in Payment of Assessments.

(a) The payment of any assessment or installment thereof due the Association shall be in default if such assessment or any installment thereof is not paid to the Association on or before the due date for such payment. When in default, the delinquent assessment or delinquent installment due the Association shall bear interest at eighteen percent (18%) until such delinquent assessment or installment and all interest due thereon has been paid in full. The Association shall have a lien against Units for delinquent assessments. Said lien shall secure and does secure the monies due for all assessments then or thereafter levied against the Unit, and such lien shall also secure interest, if any, which may be due on the amount of any delinquent assessment owing the Association. Said lien shall also secure all costs and expenses, including late penalties and reasonable attorneys' fees incurred by the Association in collecting delinquent assessments and enforcing the lien upon said Unit and its appurtenant undivided interest in the Common Elements or Limited Common Elements. The lien granted to the Association may be foreclosed in the same manner as real estate mortgages in the State of Alabama containing a power of sale

pursuant to Alabama Code §§ 35-10-11 *et seq.* as it may be amended, but the Association shall give reasonable advance notice of its proposed action to the Unit Owner, the Mortgagee and all other lienholders of record. The lien granted to the Association shall further secure such advances for taxes and payment on account of superior mortgages, liens or encumbrances which may be required to be advanced by the Association in order to protect and preserve its lien, and the Association shall further be entitled to interest at eighteen percent (18%) on any such advance made for such purpose. All persons, firms or corporations who shall acquire, by whatever means, any interest in the ownership of any Unit or who may be given or acquire a mortgage, lien or other encumbrance thereon are hereby placed on notice of the lien rights granted to the Association and shall acquire such interest in any Unit expressly subject to the lien.

(b) The lien herein granted to the Association shall be effective from and after the time of recording in the Probate Office, the Declaration of Condominium of [XYZ] Condominium and no further recordation of any claim of lien for assessment under this section is required. Such lien shall include only assessments which are due and payable when the action to enforce the lien is commenced plus late penalties and penalties imposed by the Association for Rules and Regulations violations, interest, costs, reasonable attorneys' fees, advances to pay taxes and prior encumbrances and interest thereon, all as above provided.

Section 5.08 Required Reserve Funds. Assessments levied by the Board of Directors of the Association shall include an adequate reserve fund for maintenance, repair and replacement of those Common Elements and Limited Common Elements that must be replaced or repaired on a periodic basis, and shall be payable in regular installments. Special assessments may be levied by the Board in the event that there is insufficient money in the reserve fund for the maintenance, repair or replacement of any portion of the Common Elements or Limited Common Elements.

Section 5.09 Election of Remedies. Institution of a suit at law to collect payment of any delinquent assessments shall not be deemed to be an election by the Association which shall prevent its thereafter seeking enforcement of the collection by foreclosure of any sums remaining owing to it. Nor shall proceeding by foreclosure to effect such collection be deemed to be an election precluding the institution of a suit at law to collect any sum then remaining owing to the Association. The Association shall be entitled to bid at any sale held in connection with the foreclosure of the assessment lien and may apply as a cash credit against its bid all sums secured by the lien enforced.

ARTICLE VI

MAINTENANCE AND OPERATION OF THE CONDOMINIUM PROPERTY

Section 6.01 The Association's Obligation to Repair. The Association, acting through the Board of Directors, shall be responsible for the maintenance, repair and replacement of the following, the cost of which shall be charged to all Unit Owners as a Common Expense:

- (i) The Common Elements, which by definition excludes the surfaces of all interior walls, floors, and ceilings, of a Unit;
- (ii) Incidental damage caused to a Unit by any work done by the Association; and
- (iii) Portions of Common or Limited Common Elements contained in the Units contributing to the support of the building, including outside walls and load bearing columns, support beams, and joists excluding, however, interior wall, ceiling and floor surfaces.

The Association shall be responsible for the maintenance, repair and replacement of the exterior doors and windows of the Units, which include all surrounding encasements, framing, thresholds and wood supports, the cost of which shall be assessed against the Unit Owner. The Unit Owner shall be responsible for the maintenance, repair and replacement of the door handles and associated locks, but may not change the color or design of the door handle and associated locks without written approval of the Board of Directors. The Association, acting through the Board of Directors, also shall be responsible for the maintenance, repair and replacement of the Limited Common Elements, the cost of which shall be charged to all Unit Owners to which said Limited Common Elements being maintained repaired or replaced attach as a Limited Common Expense.

This Section 6.01 shall not relieve a Unit Owner of liability for damage to the Common Elements, Limited Common Elements, a Unit of another person, adjacent property or any other property as a consequence of the negligence, recklessness or willful misconduct of the Unit Owner, Occupant, family members, guests, invitees, lessees or licensees. The cost of repair for any resulting damage including attorneys' fees, expenses, and insurance deductibles incurred by the Association shall be a special assessment against the Unit Owner and the Unit.

Section 6.02 Each Owner's Obligation to Repair.

- (a) Except for those portions of the Condominium Property which the Association is required to maintain and repair, each Owner shall, at such Owner's expense, maintain his or her Unit in good tenantable condition and repair, and shall be responsible for the repair, maintenance and replacement, if necessary, of the following items in his Unit:
 - (i) The fixtures and equipment in his Unit, including all appliances within the Unit; drains, sinks, plumbing and plumbing fixtures and connections within the Unit and serving only the Unit; electrical panels, wiring, outlets and electric fixtures within the Unit; interior doors, interior surfaces of the window frames, screening and glass; and interior surface of all exterior doors and windows; all wall coverings including paint, wallpaper and light coverings; and all floor coverings, including carpeting, hardwood, vinyl and ceramic tile within a Unit.
 - (ii) The plumbing, heating, air conditioning and electrical systems serving only that Unit, whether located within or without the boundary of that Unit,

including the fuse boxes, wiring, flues, and all other plumbing, electrical, gas or mechanical systems. In the event any such system or a portion thereof is within another Unit or requires access to another Unit, the repair, maintenance or replacement thereof shall be performed by the Association, and the cost thereof shall constitute an assessment against the Unit Owner responsible therefore.

(b) Each Unit Owner agrees as follows:

(i) To perform all maintenance, repairs and replacements which are his obligations under subparagraph (a) of this Section 6.02;

(ii) To pay all utilities as herein provided and all taxes levied against his Unit;

(iii) Not to make, or cause to be made, repairs to any plumbing, heating, ventilation or air conditioning systems located outside his Unit but required to be maintained by him under subparagraph 6.02(a)(ii), except by licensed plumbers, electricians or heating and air conditioning professionals authorized to do such work by the Association or its delegate;

(iv) Not to make any addition or alteration to the Unit or to the Common Elements or Limited Common Elements or to do any act that would impair the structural soundness, safety or overall design scheme of any part of the Condominium Property or that would impair any easement or right of a Unit Owner without the prior written consent of the Association and all Unit Owners affected thereby;

(v) Not to make any alteration, addition, improvement, decoration, repair, replacement or change to the Common Elements, Limited Common Elements, or to any outside or exterior portion of the Unit, including, but not limited to, altering in any way exterior doors, affixing outshutters to windows or painting any part of the exterior part of the Unit, without the prior written consent of the Association; provided that if such consent is granted, the Unit Owner shall use only a contractor approved by the Association, who shall comply with all Rules and Regulations with respect to the work which may be adopted by the Association, and the Unit Owner shall be liable for all damages to another Unit or to the Common Elements or Limited Common Elements caused by any contractor employed by such Unit Owner or by the subcontractors or employees of such contractor, whether said damages are caused by negligence, accident, or otherwise;

(vi) (1) regularly inspect the parts of the Condominium that the Unit Owner maintains for the existence of mold, mildew, and/or water intrusion and/or damage; (2) upon discovery, immediately repair in a good and workmanlike condition the source of any water intrusion in the parts of the Condominium that the Unit Owner is responsible for maintaining; (3) remediate or replace any building material located in the parts of the Condominium that the Unit Owner is responsible for maintaining that has absorbed water or moisture as a result of water

intrusion; and (4) promptly and regularly remediate all mold and/or mildew discovered in the parts of the Condominium that the Unit Owner maintains in accordance with current industry-accepted methods. In addition, each Unit Owner shall notify the Association of the discovery of mold, mildew, and/or water intrusion and/or damage in the Units, and the Association shall notify the Developer of the discovery of mold, mildew, and/or water intrusion and/or damage in any part of the Condominium should the Developer own any Units at that time.

(vii) To promptly report to the Association any defects or needed repairs for which the Association is responsible; and

(viii) To promptly fix, or cause to be fixed, any violation discovered during an inspection of the Unit pursuant to Section 7.04 hereof after the Unit Owner has been provided with written notice of the violation(s). The Association may levy a fine pursuant to Section 5.01 hereof against a Unit Owner that fails to promptly address such violations.

(c) The Association shall be obligated to answer any request by a Unit Owner for any required approval of a proposed addition, alteration or improvement (by painting or otherwise) within forty-five (45) days after such request, but its failure to do so within the stipulated time shall not constitute a consent of the Association to the proposed addition, alteration or improvement. Any application to any governmental authority for a permit to make an addition, alteration or improvement in or to any Unit shall be executed by the Association, without, however, it incurring any liability on the part of the Board of Directors or any of them or the Association to any contractor, subcontractor or materialman on account of such addition, alteration or improvement, or to any person having any claim of injury to a person or damage to property arising therefrom. The review by the Association under this Section 6.02 shall in no way make the Association liable for any alterations, additions, or improvements by any Unit Owner. Rather, such review is for purposes of aesthetics and control only. The provisions of this Section 6.02 shall not apply to Units owned by the Developer until a deed for such Unit has been delivered to a purchaser other than Developer.

(d) Notwithstanding the foregoing, a Unit Owner shall not cause or permit any portion of the upper, lower, or perimetrical boundaries of a Unit to be damaged or disturbed without first receiving written permission of the Association. Developer makes no representations as to the presence on, in, under or near the Condominium Property of any material containing asbestos; however, each Unit Owner acknowledges that asbestos may be present on, in, under or near the Condominium Property, including those areas beyond the upper, lower, and perimetrical boundaries of a Unit.

Section 6.03 Maintenance of Limited Common Elements. The Limited Common Elements shall be maintained in accordance with the following:

(a) Each Unit Owner shall keep the Limited Common Elements appurtenant to the Unit in a clean, neat and presentable appearance and shall not allow such areas to be used for anything other than its intended use; and

(b) The Association shall perform all other maintenance and repair of the Limited Common Elements, the expense of which shall be a Limited Common Expense assessed against the Unit(s) and Unit Owner(s) to which the Limited Common Elements are appurtenant.

Section 6.04 Alterations, Additions and Improvements by the Association.

Except in the case of loss or damage to the Common Elements or Limited Common Elements as contemplated by Article IX of the Declaration, the Association shall not make any material structural alterations, capital additions or capital improvements to the Common Elements or Limited Common Elements the cost of which is estimated to exceed \$50,000.00 unless the same is authorized by the Board of Directors of the Association and ratified by the affirmative vote of the voting members casting not less than sixty-six and two-thirds percent (66.67%) of the total votes of the members of the Association present at any regular or special meeting of the Unit Owners called for that purpose at which a quorum is present and approved by a majority of the Mortgagees eligible to vote therefore. The cost of the foregoing shall be assessed against the Owners of Units as provided in Article V hereof except as otherwise provided in this Section 6.04. Where any alterations or additions as aforesaid are exclusively or substantially exclusively for the benefit of the Unit Owners requesting the same, then the cost of such alterations or additions shall be assessed against and collected solely from the Unit Owners exclusively, or substantially exclusively, benefiting therefrom, and the assessment shall be levied in such proportions as may be determined to be fair and equitable by the Board of Directors of the Association. Where such alterations or additions exclusively, or substantially exclusively, benefit Unit Owners requesting the same, said alterations and additions shall be made only when authorized by the Board of Directors and ratified by not less than sixty-six and two-thirds percent (66.67%) of the total votes of the Unit Owners exclusively, or substantially exclusively, benefiting there from. Alterations, improvements or repairs of an emergency nature may be made upon authorization by a vote of the majority of the Directors available for consultation if the same is necessary and in the best interest of the Unit Owners. Nothing in this Section 6.04 shall relieve the Association from its obligation to maintain, repair and replace the Condominium Property as described in the Condominium Documents and the Act.

Section 6.05 Utilities and Services. The utilities including water, power, and cable serving the Common or Limited Common Elements only shall paid by the Association as a Common or Limited Common Expense. The Association shall have authority with regard to any utility, to use a common meter, pay the cost of such utilities used or consumed in the Units, and have the costs thereof apportioned among the Units based upon the Common or Limited Common Expense liability, use of the utility, or any other formula the Association may deem appropriate or it may install separate meters for each of the Units and the Common Elements. The Association may enter into an agreement with a third party to provide internet service for the Condominium Property and may pay the cost of such internet service used or consumed on the Condominium Property, and have the costs thereof apportioned among the Units based upon the Common or Limited Common Expense liability, use of the service, or any other formula the Association may deem appropriate.

ARTICLE VII

RESTRICTIONS ON USE OF UNITS, COMMON ELEMENTS

Section 7.01 Rules and Regulations of the Association. The Association is authorized to promulgate, amend and enforce Rules and Regulations concerning the operation and use of the Condominium; provided that such Rules and Regulations are not contrary to or inconsistent with the Act and the other Condominium Documents. A copy of the Rules and Regulations shall be furnished by the Board of Directors to each Unit Owner prior to the time they become effective. All present and future Unit Owners, tenants, and Occupants of the Units and any person who uses any part of the Condominium Property in any manner, are subject to, and shall comply with the provisions of the Condominium Documents, including, without limitation, the Rules and Regulations. The acquisition, rental or occupancy of a Unit or the use of any part of the Condominium Property by any one person shall constitute his agreement to be subject to and bound by the provisions of the Condominium Documents, including, without limitation, the Rules and Regulations, and such provisions shall be deemed to be enforceable as equitable servitudes and covenants running with the land and shall bind any person having at any time any interest or estate in such Unit, as though such provisions were recited and stipulated in full in each and every deed of conveyance or lease thereof. The Association may promulgate enforcement provisions for violation of any Rule or Regulation by a member, his guests, invitees, lessees or tenants, including the payment of penalties for such violations.

Section 7.02 Restrictions on Use. The use of the Condominium Property is subject to the following restrictions:

(a) Each Unit is hereby restricted to residential use in accordance with the Rules and Regulations of the Association and as allowed by the City of Mountain Brook.

(b) There shall be no obstruction of the Common Elements, nor shall anything be kept or stored in the Common Elements, nor shall anything be constructed on or planted in or removed from the Common Elements, nor shall the Common Elements in any other way be altered without the prior written consent of the Association.

(c) No immoral, improper, offensive or unlawful use shall be made of any Unit or Common Elements or any part thereof, and all laws, zoning ordinances and regulations of all governmental authorities having jurisdiction over the Condominium Property shall be observed.

(d) No Owner shall permit anything to be done or kept in his Unit or in the Common Elements which will result in any increase of fire or hazard insurance premiums or the cancellation of insurance on any part of the Condominium Property, or which would be in violation of any law. No waste shall be committed to the Common Elements.

(e) No noxious or offensive activities shall be carried on, nor shall anything be done, on any part of the Condominium Property which in the judgment of the Board of Directors of the Association may be or become an unreasonable annoyance or nuisance to the other Owners.

(f) Smoking including, but not limited to, tobacco products or electronic cigarettes is prohibited on the Condominium Property.

(g) No Owner shall cause or permit anything to be placed on the Common Elements immediately surrounding the Unit. No sign, awning, canopy, window air conditioning unit, shutter, or other fixture shall be affixed to or placed upon the exterior walls or roof of the building, or any part of the Common Elements, without the prior written consent of the Board of Directors of the Association.

(h) No satellite dishes over one (1) meter shall be allowed on the Condominium Property at any time. Satellite dishes less than one (1) meter shall not be allowed on any part of the Common Elements of the Condominium except with the express approval of the Board of Directors as to location of the receiving equipment or dish.

(i) No clothes, sheets, blankets, laundry of any kind or other articles shall be hung out or exposed from or on any part of the Common Elements. The Common Elements shall be kept clear of rubbish, debris and other unsightly materials.

(j) No waterbed or aquarium exceeding five (5) gallons shall be placed or utilized in any Unit.

(k) Applicable building codes require that all clothes dryers installed in the Units must have specified venting characteristics. Accordingly, Unit Owners may install and replace their clothes dryers only with dryers meeting the required building code specifications.

(l) No one shall use or permit to be brought into any Unit or upon any of the Common Elements and facilities any flammable oils or fluids such as gasoline, kerosene, naphtha or benzene, or other explosives or articles deemed extra hazardous to life, limb or property, without the written consent of the Board of Directors of the Association.

(m) No animal or pet shall be kept for commercial purposes, nor be allowed to create or cause any disturbance or nuisance of any kind, and if an animal or pet does cause or create a nuisance or an unreasonable disturbance, said animal or pet shall be permanently removed from the Condominium Property within seven (7) days from the date the Owner receives written notice from the Board of Directors to remove such animal or pet. The Owner of any pet or animal shall be liable for any and all damage caused by such animal or pet to any part of the Condominium Property. No Owner shall keep more than two (2) domesticated cats or dogs in a Unit at any given time without prior written approval of the Board of Directors. In addition, no snakes, or animals deemed vicious or dangerous in the sole discretion of the Board may be brought onto or kept on the Condominium Property at any time. The Board shall have authority to pass and enforce Rules and Regulations regarding the keeping of pets on the Condominium Property, and charge a fee for the registration of such pet(s).

(n) No structure of a temporary character, trailer, tent, shack, carport, garage, barn or other outbuilding shall be erected by any Owner, other than the Developer, on any

portion of the Condominium Property, at any time, either temporarily or permanently, without the prior written approval of the Board.

(o) The display or discharge of firearms or fireworks on the Common Elements is prohibited; provided, however, that the display of lawful firearms on the Common Elements is permitted by law enforcement officers and also is permitted for the limited purpose of transferring firearms across the Common Elements to or from an Owner's Unit so long as the firearm is not loaded and not carried in a threatening manner. The term "firearms" includes "B-B" guns, pellet guns and other firearms of all types, regardless of size.

(p) No Owner or Occupant of the Units restricted to residential use may conduct any business, trade, garage sale, moving sale, rummage sale, or similar activity at or about the Condominium, whether within a Unit or otherwise, except that an Owner or Occupant residing in Unit may conduct business activities within the Unit so long as: (i) the existence or operation of the business activity is not apparent or detectable by sight, sound or smell from outside the Unit; (ii) the business activity conforms to all zoning and other legal requirements for the Condominium; (iii) the business activity does not, in the Board's reasonable judgment, generate any vehicular or pedestrian traffic or increase the number of vehicles being parked on the Condominium; and (iv) the business activity is consistent with the residential character of the Unit and does not constitute a nuisance, or a hazardous or offensive use, or threaten the security or safety of other residents of the Condominium, as may be determined in the sole discretion of the Board. The terms "business" and "trade", as used in this provision, shall be construed to have their ordinary, generally accepted meanings and shall include, without limitation, any occupation, work, or activity undertaken on an ongoing basis which involves the provision of goods or services to persons other than the provider's family and for which the provider receives a fee, compensation, or other form of compensation.

Section 7.03 Lease of Units. Units may be leased by the Unit Owners; provided, however, that any such lease and the rights of any tenant thereunder are hereby made expressly subject to the power of the Association to prescribe reasonable rules and regulations relating to the lease and rental of Units and to enforce the same directly against such tenant or other Occupant by the exercise of such remedies as the Board deems appropriate; provided, however, that no restrictions shall be imposed which shall have the individual or cumulative effect of prohibiting or materially impairing the rental or lease of Units. No individual rooms may be rented in the Units restricted to residential use. Further, all leases must be in writing for a term no less than _____ (__) _____, with a copy provided to the Association upon request by the Association and may be redacted to prevent sharing information related to the amount of rent. This restriction on use shall be a covenant running with each Unit, creating a burden on each single Unit and Unit Owner for the benefit of every other Unit and Unit Owner.

Notwithstanding anything contained in this Section to the contrary, each Owner shall be responsible for the actions of his tenants and nothing herein or in any such lease shall relieve an Owner of his obligations under the Condominium Documents. Each Unit Owner who has or who shall lease his Unit irrevocably empowers and authorizes the Association or its

managing agent to enforce the Rules and Regulations of the Association and to terminate the lease of and evict any tenant who fails to comply with said Rules or who provides other sufficient cause for termination of the lease and eviction in accordance with the laws of the State of Alabama, the Condominium Documents or any contract for lease. The Association, the Board or its managing agent shall not become liable to any Unit Owner or sublessor or other party for any loss of rents or other damages resulting from the reasonable exercise of the provisions of this Section. The provisions of this Section shall not be applicable to the Developer who is irrevocably empowered without any limitation at all times, whether for permanent or temporary occupancy to sell, lease or rent Units for any period and under any terms to any lessees or purchasers or transferees with the right to take any action necessary to consummate the sale or rental of said Units, including, but not limited to, the right to maintain model Units, post signs, have employees in the offices maintained in the Condominium buildings, use the Common Elements and show Units to prospective tenants. Sales and rental office signs and all items pertaining to the rental or sale of Units shall not be considered Common Elements and shall remain the property of the Developer.

Section 7.04 Right of Access. Each Unit Owner grants a right of access to his Unit to the Association, and any other person authorized by the Association for the purpose of making inspections and for the purpose of correcting any condition originating in his Unit and threatening other Units or Common Elements or for the purpose of performing installations, alterations or repairs to the mechanical or electrical services or other Common Elements on his Unit, if any, or to correct any condition which violates the provisions of any Mortgage covering another Unit, or to enforce any provision of the Condominium Documents, provided that requests for entry are made in advance and that such entry is at a time reasonably convenient to the Unit Owner. In case of an emergency, such right of entry shall be immediate whether the Unit Owner is present at the time or not. To the extent that damages are inflicted on the Common Elements or any Unit through which access is taken, the Unit Owner or the Association, if it caused the same, shall be liable for the prompt repair thereof. Access codes, remotes, or other security passwords shall not be provided to any person other than the Unit Owner, an Occupant under an approved lease, and the Association's management company.

Section 7.05 Limitation of Liability. The Association shall not be liable for any failure of water or power supply, telephone, security, fire protection or other service to be obtained by the Association or paid for out of the Common Expense funds, for problems resulting from the operation or lack of operation of sewer lines servicing the Condominium Property, or for injury or damage to a person or property caused by the natural elements or resulting from electricity, water, snow or ice which may leak or flow from any portion of the Common Elements or from any wire, pipe, drain, conduit, appliance or equipment. The Association shall not be liable to the Owner of any Unit for loss or damage, by theft or otherwise, of articles which may be stored upon any of the Common Elements. No diminution or abatement of the Common Expense assessments, as herein elsewhere provided, shall be claimed or allowed for inconvenience or discomfort arising from the making of repairs or improvements to the Common Elements or to any Unit, or from any action taken by the Association to comply with any law or ordinance or with the order or directive of any municipal or other governmental or judicial authority or for the dispossession of the Unit Owner by reason of fire or other casualty, except to the extent covered by insurance.

Section 7.06 Abatement of Violations. The violation of any Rule or Regulation adopted by the Board of Directors of the Association or breach of the provisions of the Condominium Documents, shall give the Developer, the Association or any Unit Owner the right, in addition to any other right or remedy elsewhere available, to enjoin, abate or remedy by appropriate legal proceedings, either at law or in equity, the continuance of any such breach. All expenses of such actions or proceedings against a defaulting Unit Owner, including court costs, attorney's fees and other fees and expenses, and all damages, liquidated or otherwise, together with interest thereon at the highest lawful rate on judgments until paid, shall be charged to and assessed against such defaulting Owner, and the Association shall have a lien for all of the same upon the Unit of such defaulting Owner, upon all of his additions and improvements thereto and a security interest under the Alabama Uniform Commercial Code upon all of his personal property in his Unit or located elsewhere on the Condominium Property. Nothing herein contained shall prevent an Owner from maintaining such an action or proceeding against the Association and the expense of any action to remedy a default of the Association shall be a Common Expense if a court of competent jurisdiction finds the Association to be in default as alleged in such action or proceeding.

Section 7.07 Failure of the Association to Insist on Strict Performance; No Waiver. Failure of the Association to insist in any one or more instances upon the strict performance of any of the terms, covenants, conditions or restrictions of this Declaration, or to exercise any right or option herein contained, or to serve any notice or to institute any action shall not be construed as a waiver or a relinquishment from the future performance of such term, covenant, condition or restriction but such term, covenant, condition or restriction shall remain in full force and effect. The receipt by the Association of any assessment from an Owner with knowledge of the breach of any covenant hereof shall not be deemed to be a waiver of such breach and no waiver by the Association of any provision hereof shall be deemed to have been made unless expressed in writing and signed by the Board of Directors of the Association.

ARTICLE VIII

RIGHTS OF MORTGAGEES

Section 8.01 Notification of Mortgagees Required. Any Mortgagee shall have the right to be given written notification by the Association of (a) any sixty (60) day default by the Owner of the Unit covered by the Mortgage in the payment of assessments or in any other provision of the Condominium Documents; (b) any loss to or taking of the Common Elements or Limited Common Elements if such loss or taking exceeds \$10,000; (c) damage to a Unit covered by the Mortgage if the amount of such damage exceeds \$10,000; (d) any condemnation of all or a portion of the Condominium Property; (e) a lapse or cancellation or material modification of any insurance policy or fidelity bond maintained by the Association; and (f) any proposed action that requires the consent of a specified percentage of Mortgagees if such Mortgagee has given notice to the Association of its interest in the Condominium.

Section 8.02 Right of Inspection. Mortgagees shall have the right to examine the books and records of the Association or the Condominium Property during normal business hours and to receive annual reports, other financial data, and, upon request, an annual audited

statement, within one hundred twenty (120) days following the end of any fiscal year of the Association. If a Mortgagee requests an annual audited statement, the Mortgagee and the Association shall share equally the cost of the audit.

Section 8.03 Priority of Mortgagees.

(a) Any lien which is or may be created hereunder upon any Unit, including, but not limited to, the lien created for assessments under Section 5.07 hereof and the right to foreclose the same is and shall be subject and subordinate to and shall not affect the rights of the holder of the indebtedness secured by any Mortgage upon such interest made in good faith and for value and recorded prior to the creation of the lien hereunder, provided that after the foreclosure of any such Mortgage there may be a lien created pursuant to Section 5.07 hereof on the interest of the purchaser as an Owner after the date of such foreclosure sale to secure all assessments hereunder. After the date of such foreclosure sale, said lien, if any, shall be claimed and shall have the same effect and be enforced in the same manner provided herein.

Notwithstanding the above, the lien created pursuant to Section 5.07 hereof is prior to any Mortgage to the extent of the Common Expense assessments based on the annual budget which would have become due in absence of acceleration during the six (6) months immediately preceding institution of an action to enforce the lien.

(b) No provision of this Declaration, the Certificate of Formation, the Bylaws or the Rules and Regulations shall be construed to grant to any Unit Owner, or to any other party any priority over any rights of the Mortgagees of the Units pursuant to their Mortgages in the case of distribution to Unit Owners of the insurance proceeds or condemnation awards for losses or a taking of Units or the Common Elements, the Limited Common Elements or any portion thereof.

(c) As provided in the Act, all assessments, property taxes and other charges imposed by any taxing authority which may become liens prior to a Mortgage, shall be separately assessed against and collected on each Unit as a single parcel, and not on the Condominium Property as a whole.

(d) No breach of the covenants, conditions or restrictions herein contained shall defeat or render invalid the lien of any Mortgage made in good faith and for value, but all of said covenants, conditions and restrictions shall be binding upon and effective against any Owner whose title is derived through foreclosure or otherwise.

Section 8.04 Request for Protection by Mortgagees. Whenever the holder of any Mortgage desires the benefit of the provisions of Article VIII, Section 8.01 to be applicable to it, it shall serve written notice of such fact upon the Association, by registered or certified mail, addressed to the Association's registered agent, identifying the Unit upon which it holds a Mortgage or identifying any Units owned by it, together with sufficient pertinent facts to identify any Mortgage which may be held by it. Said notice shall designate the place to which the notices are to be given by the Association to such Mortgagee. Should the Association send notice via certified mail of any action requiring the affirmative vote of the Mortgagee, and the Mortgagee

shall not respond within sixty (60) days from notice of such right, the Mortgagee shall be deemed to have given its implied consent to such action.

ARTICLE IX

CASUALTY LOSS AND INSURANCE

Section 9.01 Responsibility of Owners; Separate Insurance Coverage.

(a) The Owner of each Unit may, at his or her expense, obtain insurance coverage for loss of or damage to any furniture, furnishings, personal effects, and other property belonging to such Owner, and shall, at his or her expense, obtain insurance coverage against personal liability for injury or damage to the person or property of another while within such Owner's Unit or upon the Common Elements or Limited Common Elements in an amount not less than \$1,000,000.00. If a Unit Owner leases his Unit, such insurance shall cover any act by any Occupant. Risk of loss of or damage to any furniture, furnishings and personal property belonging to or carried on the person of the Owner, or which may be stored in any Unit, or in or upon Common Elements or Limited Common Elements, shall be borne by the Owner of each Unit. All furniture, furnishings and personal property constituting a portion of the Common Elements or Limited Common Elements and held for the joint use and benefit of all Owners of Units shall be covered by such insurance as shall be maintained in force and effect by the Association as hereinafter provided. Each Owner shall be required to notify the Association of all improvements made by the Owner to his Unit, the value of which is in excess of \$10,000. All insurance obtained by the Owner of each Unit shall, whenever such provisions shall be available, provide that the insurer waives its right of subrogation as to any claims against other Owners, the Association or Developer, and their respective servants, agents, employees and guests.

(b) Any Owner who obtains an individual insurance policy covering any portion of the Condominium Property other than personal property belonging to such Owner shall be required to file a copy of such individual policy or policies with the Association within thirty (30) days after the purchase of such insurance. In the event casualty insurance maintained by an Owner causes a decrease in the amount of the insurance coverage maintained by the Association for the benefit of all Owners on a casualty loss to the Condominium Property by reason of proration or otherwise, the Owner so maintaining such insurance shall be deemed to have assigned to the Association the proceeds collected on such policy for loss or damage to the Condominium Property and such proceeds shall be paid directly to the Association by the insurer. Any such insurance proceeds shall be applied and distributed by the Association in accordance with this Article IX.

Section 9.02 Insurance to be Maintained by the Association.

(a) **Hazard Insurance.** The Association shall obtain and maintain at all times a policy or policies of multi-peril type hazard insurance, including insurance for such other

risks of a similar or dissimilar nature, as are or shall hereafter customarily be covered with respect to other condominium projects similar in construction, design and use, insuring the Condominium Property against loss or damage by the perils of fire, lightning and those perils contained in extended coverage, vandalism and malicious mischief endorsements, and if the Condominium Property is located in an area identified by the Secretary of Housing and Urban Development as having special flood hazards, the Board shall, to the extent obtainable, insure the insurable property included in the Condominium Property against the perils of flood under the National Flood Insurance Act of 1968 and acts amendatory thereto. The amount of insurance coverage shall be determined on a replacement cost basis in an amount not less than one hundred percent (100%) of the then current replacement cost of the improvements which constitute the Condominium Property, including the Common Elements, Limited Common Elements and the Unit as purchased by the Unit Owner (but excluding land, foundations, excavations and other items usually excluded from such insurance coverage). Such insurance coverage shall be written in the name of, and the proceeds thereof shall be payable to, the Association or the Insurance Trustee (hereinafter defined), as trustee for the use and benefit of the individual Owners (without naming them) in the proportionate shares equal to their respective percentage ownership of the Common Elements. Periodically, prior to the renewal of any such policy or policies of insurance, the Association should obtain an opinion or an appraisal from a qualified appraiser for the purpose of determining the full replacement cost of the Common Elements, the Limited Common Elements and the Units for the amount of insurance to be obtained pursuant hereto. The cost of any such opinion or appraisal shall be a Common Expense. All such policies of insurance shall comply with the provisions of Section 9.03 hereof and shall (i) contain standard mortgagee clause endorsements in favor of the Mortgagee or Mortgagees of each Unit, if any, as their respective interest may appear; and (ii) provide that the insurance shall not be invalidated by any act or neglect of any Owner.

(b) Public Liability and Property Damage Insurance. The Association shall obtain and maintain at all times a comprehensive policy or policies of public liability and property damage insurance in such amount (but not less than \$1,000,000) and in such form as shall be required by the Association to protect said Association and the Owners of all Units which provide coverage for bodily injury and property damage resulting from the operation, maintenance or use of the Common Elements and Limited Common Elements and for legal liability resulting from employment contracts to which the Association is a party.

(c) Workmen's Compensation Insurance. If required by the laws of the State of Alabama, the Association shall obtain and maintain at all times a policy or policies of workmen's compensation insurance to meet the requirements of the laws of the State of Alabama.

(d) Fidelity Bonds. The Association may obtain and maintain fidelity bonds for any person who either handles or is responsible for funds held or administered by the Association naming the Association as the obligee. The amount of the fidelity bond should cover the maximum funds that will be in the custody of the Association, but not less than

the sum of three (3) months' assessments on all Units plus the reserve funds of the Association.

(e) Directors and Officers Liability Insurance. The Association may maintain Directors and Officers liability insurance in an amount to be determined by the Board of Directors.

(f) Other Insurance. The Association shall obtain and maintain such other insurance coverage as the Board of Directors of the Association, in its sole discretion, may determine from time to time to be in the best interest of the Association and the Owners of all Units.

Section 9.03 Governing Provisions. All insurance obtained and maintained by the Association as provided in Section 9.02 above shall be governed by the following provisions:

(a) All policies shall (i) comply with the hazard and casualty insurance requirements of the Federal Home Loan Mortgage Corporation and the Federal National Mortgage Association as they shall apply to condominium loans; and (ii) be written with a company licensed to do business in the State of Alabama and holding a financial rating of Class V or better and a general policyholders rating of "A" or better by Best's Insurance Reports or other then comparable rating. To the extent that the provisions of this Declaration with respect to the maintenance of insurance shall conflict with the hazard and casualty insurance requirements of the Federal Home Loan Mortgage Corporation or the Federal National Mortgage Association, then the requirements of the Federal Home Loan Mortgage Corporation and the Federal National Mortgage Association shall control and such requirements shall be complied with by the Association.

(b) Exclusive authority to adjust all claims under the policies hereafter in force on the Condominium Property shall be vested in the Association or its authorized representatives.

(c) In no event shall the insurance coverage obtained and maintained by the Association hereunder be brought into contribution with the insurance purchased by the individual Owners or their Mortgagees.

(d) The Association shall be required to make every effort to secure insurance policies that will provide for the following:

(i) A waiver of subrogation by the insurer as to any claims against the Association, the Board of Directors, the Developer or the Owners;

(ii) An agreement by the insurer that the insurance coverage cannot be terminated or materially changed without thirty (30) days prior written notice to the Association and the Mortgagee of each Unit;

(iii) The insurance coverage will be primary, even if a Unit Owner has other insurance that covers the same loss; and

(iv) No act or omission by any Unit Owner, unless acting within the scope of his authority on behalf of the Association, will void the policy or be a condition to recovery under the policy.

Section 9.04 Premiums and Deductibles. Premiums for insurance policies purchased by the Association shall be paid by the Association as a Common Expense; except that the amount of increase over the usual premium occasioned by the use, misuse, occupancy or abandonment of a Unit or its appurtenances or of the Common Elements or Limited Common Elements by an Owner shall be assessed against that Owner. Any deductible incurred by reason of a loss or claim under any insurance policy purchased under this Article IX shall be paid by the Association, unless such loss or claim was caused by a Unit Owner or Occupant, family member, lessee, guest or invitee thereof, resulted from the use, misuse, occupancy, negligence or abandonment of a Unit or any portion thereof, or the cause arose from the Owner's Unit even through no fault of the Unit Owner. In such event the Unit Owner from whose Unit the cause originated, will be responsible for the deductible under the Association's insurance policy, which may be assessed against that Unit Owner as a special assessment.

Section 9.05 Insurance Trustee. The Association may engage the services of a bank or trust company authorized to do trust business in the State of Alabama and having a capital and surplus of not less than \$50,000,000 to act on its behalf as an insurance trustee ("Insurance Trustee") and to receive and disburse the insurance proceeds in accordance with the provisions of this Declaration. In the event the lowest of two bids from reputable contractors for making all repairs required by any such loss shall exceed \$50,000, the Association upon written demand of the Mortgagee or Owner of any Unit shall engage the services of a bank or trust company to act as Insurance Trustee as aforesaid. The Association, as a Common Expense, shall pay a reasonable fee to said Insurance Trustee for its services rendered hereunder, and shall pay such costs and expenses as said Insurance Trustee may incur in the performance of any duties and obligations imposed upon it hereunder. Said Insurance Trustee shall be liable only for its willful misconduct, bad faith or gross negligence, and then for only such money which comes into the possession of said Insurance Trustee. Whenever the Insurance Trustee may be required to make distribution of insurance proceeds to Owners of Units and their Mortgagees, as their respective interests may appear, or to any other party for repair, replacement or reconstruction of property, the Insurance Trustee may rely upon a certificate of the President and Secretary of the Association, executed under oath, which certificate will be provided to said Insurance Trustee upon request made to the Association. Such certificate is to certify unto said Insurance Trustee the name of the Owner of each Unit, the name of the Mortgagee who may hold a Mortgage encumbering each Unit, and the respective percentages of any distribution which may be required to be made to the Owner of any Unit, and his respective Mortgagee, as their respective interests may appear, or to certify the name of the party to whom payments are to be made for repair, replacement or reconstruction of all or a portion of the Condominium Property. The rights of the Mortgagee of any Unit under any standard mortgage clause endorsement to such policy shall, notwithstanding anything to the contrary therein or in any Mortgage contained, at all times be subject to the provisions hereof with respect to the application of insurance proceeds to reconstruction of the damaged Condominium Property; provided, however, that if the Association or the Insurance Trustee fails to perform all the conditions precedent required by the policy or policies of insurance, and fails to collect the amount of the loss within the time required by law, and the Mortgagee or Mortgagees are required to avail

themselves of their rights under the standard mortgage clause to collect the proceeds of the policy or policies of insurance, any amount so collected through the efforts of said Mortgagee or Mortgagees shall be applied as directed by said Mortgagee or Mortgagees. No provision hereof shall entitle an Owner or any other party to any priority over a Mortgagee with respect to the distribution of any insurance proceeds with respect to such Unit.

Section 9.06 Loss to Common Elements Only. In the event of the loss of or damage to only Common Elements, real or personal, by reason of fire or other casualties, which loss or damage is covered by fire and casualty insurance, the proceeds paid to the Association or the Insurance Trustee, as the case may be, to cover such loss or damage shall be applied to the repair, replacement or reconstruction of such loss or damage. If the insurance proceeds are in excess of the cost of the repair, replacement or reconstruction of such Common Elements, then such excess insurance proceeds shall be paid by the Insurance Trustee to the Owners of all Units, the distribution to be separately made to the Owner of each Unit and his respective Mortgagee, as their interests may appear, in such proportion that the share of such excess insurance proceeds paid to the Owner of each Unit and his Mortgagee shall bear the same ratio to the total excess insurance proceeds as the undivided interest in the Common Elements appurtenant to each Unit bears to the total undivided interest in the Common Elements appurtenant to all Units. If there is no insurance coverage for such loss or damage, or if it appears that the insurance proceeds covering the fire or casualty loss or damage payable to the Association or the Insurance Trustee are not sufficient to pay for the repair, replacement or reconstruction of the loss or damage, or that the insurance proceeds when collected will not be so sufficient, then the Association shall pay, or shall deposit with the Insurance Trustee, as the case may be, a sum, which together with the insurance proceeds received or to be received, if any, will enable said Insurance Trustee to completely pay for the repair, replacement or reconstruction of any loss or damage, as the case may be. The monies to be so paid, or deposited by the Association with the Insurance Trustee, may be paid by the Association out of its reserve for replacement fund and if the amount in such reserve for replacement fund is not sufficient, or if the Board of Directors determines not to use such fund for said purpose, then the Association shall levy and collect an assessment against the Owners of all Units in an amount which shall provide the funds required to pay for said repair, replacement or reconstruction.

Section 9.07 Loss to Common Elements, Limited Common Elements and/or Units. In the event of loss of or damage to Common Elements, Limited Common Elements and/or any Unit by reason of fire or other casualty, which loss or damage is covered by fire and casualty insurance, the proceeds paid to the Association or Insurance Trustee, as the case may be, to cover such loss or damage, shall be first applied to the repair, replacement or reconstruction of the Common Elements, then to the repair, replacement or reconstruction of the Limited Common Elements and any remaining insurance proceeds shall be applied to the repair, replacement or reconstruction of any Unit which may have sustained any loss or damage so covered. If the insurance proceeds are in excess of the cost of the repair, replacement or reconstruction of the Common Elements, the Limited Common Elements and the Units sustaining any loss or damage, then such excess insurance proceeds shall be paid and distributed by the Insurance Trustee to the Owners of all Units, and to their Mortgagees, as their respective interests may appear. Such distributions are to be made in the manner and in the proportions as are provided for the distribution of insurance proceeds under Section 9.06 above. If there is no insurance coverage for such loss or

damage, or if it appears that the insurance proceeds covering the fire and casualty loss or damage payable to the Association or the Insurance Trustee, as the case may be, are not sufficient to pay for the repair, replacement or reconstruction of the loss or damage, or that the insurance proceeds when collected will not be sufficient, then the Board of Directors of the Association shall, based on reliable and detailed estimates obtained by it from competent and qualified parties, determine and allocate the cost of repair, replacement or reconstruction among the Common Elements, the Limited Common Elements and the Units sustaining any loss or damage. If the proceeds of said fire or casualty insurance, if any, are sufficient to pay for the repair, replacement or reconstruction of any loss of or damage to the Common Elements and Limited Common Elements, but are not sufficient to repair, replace or reconstruct any loss of or damage to the Units sustaining damage, then the Association shall levy and collect an assessment from the respective Owners of the Units sustaining any loss or damage, and the assessment so collected from said Owners shall be deposited with the Insurance Trustee, so that the sum on deposit with said Insurance Trustee shall be sufficient to completely pay for the repair, replacement or reconstruction of all Common Elements, Limited Common Elements, and Units. In said latter event, the assessment to be levied and collected from the Owners of the Units shall be apportioned among such Owners in such manner that the assessment levied against each Owner of a Unit shall bear the same proportion to the total assessment levied against all of said Owners of Units sustaining loss or damage as the cost of repair, replacement or reconstruction of each Owner's Unit bears to the cost applicable to all of said Units sustaining loss or damage. If the fire or casualty insurance proceeds, if any, payable to the Association or the Insurance Trustee are not an amount which will pay for the complete repair, replacement or reconstruction of the Common Elements and Limited Common Elements, it being recognized that such insurance proceeds are to be first applied to the payment for repair, replacement or reconstruction of said Common Elements and Limited Common Elements before being applied to the repair, replacement or reconstruction of any Unit sustaining loss or damage, then the cost to repair, replace, or reconstruct said Common Elements and Limited Common Elements in excess of available fire and casualty insurance proceeds shall be levied and collected as an assessment from the Owners of all Units in the same manner as would be levied and collected had the loss or damage sustained been solely to the Common Elements and Limited Common Elements and the fire or casualty insurance proceeds had been insufficient to cover the cost of repair, replacement or reconstruction. The cost of repair, replacement or reconstruction of each Unit sustaining loss or damage shall then be levied and collected by assessment against the Owners of the Units sustaining the loss or damage in the same manner as is above provided for the apportionment of such assessment between Owners of any Units sustaining loss or damage.

Section 9.08 Estimates of Repair; Plans and Specifications; Payment of Assessments. In the event of loss or damage to Condominium Property for which there is complete or partial insurance coverage, the Association shall promptly repair or replace those portions of the Condominium Property for which the Association is required to obtain insurance coverage unless (i) the Condominium is terminated, or (ii) eighty percent (80%) of the Unit Owners, including every Owner of a Unit which Unit or appurtenant Limited Common Element will not be rebuilt, vote not to rebuild. The Association shall be appointed as attorney-in-fact for each Unit Owner for the purpose of representing the Unit Owners in any proceeding, negotiation, settlement, or agreement arising from any loss or damage to the Condominium Property. Whenever it shall appear that the insurance proceeds payable for such loss or damage will not be sufficient to defray the cost of repair, replacement or reconstruction thereof, the additional money

required to completely pay for such repair, replacement or reconstruction of said loss or damage whether to be paid by all of the Owners of Units or only by the Owners of Units sustaining loss or damage, or both, as herein provided, shall be paid to the Association and deposited with the Insurance Trustee, if any, not later than thirty (30) days from the date on which the Association or the Insurance Trustee, as the case may be, shall receive the monies payable from the policies of fire and casualty insurance.

ARTICLE X

CONDEMNATION

Section 10.01 Condemnation Considered a Casualty Loss. The taking of a portion of a Unit, the Common Elements or the Limited Common Elements by eminent domain shall be deemed to be a casualty loss, and except as otherwise provided in Section 10.02 below, the awards for such taking shall be deemed to be proceeds from insurance on account of the casualty and shall be applied and distributed by the Association in accordance with the provisions of Article IX. Even though the awards may be payable to the Owners, the Owners shall deposit the awards with the Association or Insurance Trustee, as the case may be; and in the event of failure to do so, in the discretion of the Board of Directors of the Association, a special assessment shall be made against a defaulting Owner in the amount of his award, or the amount of such award shall be set off against the sums hereinafter made payable to such Owner. If any Unit or portion thereof is made the subject matter of any condemnation or eminent domain proceeding or is otherwise sought to be acquired by a condemning authority, the Mortgagee of such Unit shall be entitled to timely written notice of any such proceeding or proposed acquisition as provided in Section 8.01, and no provision hereof shall entitle the Owner of such Unit or other party to priority over such Mortgagee with respect to the distribution of any award or settlement to the Owner of the Unit.

Section 10.02 Partial Condemnation. In the event that the Condominium Property is not to be terminated and one or more Units are taken in part, the taking shall have the following effects:

(a) If the taking reduces the size of a Unit and the remaining portion of that Unit can be made tenantable, the award for the taking for a portion of the Unit shall be used for the following purposes in the order stated, and the following changes shall be effected in the Condominium Property:

(i) The Unit shall be made tenantable and if the cost of such work exceeds the amount of the award, the additional funds shall be assessed against the Owner of the Unit.

(ii) The balance of the award, if any, shall be distributed to the Owner of the Unit and the Mortgagee of the Unit, as their respective interests may appear.

(iii) If there is a balance of the award distributed to the Owner and the Mortgagee, the share of the Common Elements or Limited Common Elements, if any, appurtenant to the Unit shall be equitably reduced. This shall be done by

reducing such share by the proportion which the balance of the award so distributed bears to the market value of the Unit immediately prior to the taking, and then recomputing the shares of all Owners in the Common Elements and the Owners of all Limited Common Elements as percentages of the total of their shares as reduced by the taking.

(b) If the taking destroys or so reduces the size of a Unit so that it may not be made tenantable, the award for the taking of the Unit shall be used for the following purposes in the order stated, and the following changes shall be effected in the Condominium Property:

(i) The market value of such Unit immediately prior to the taking, shall be paid to the Owner of the Unit and to each Mortgagee of the Unit, as their respective interests may appear.

(ii) The remaining portion of such Unit, if any, shall become a part of the Common Elements and shall be placed in condition for use by all of the Owners, in the manner approved by the Board of Directors of the Association; provided, however, that if the cost of such work shall exceed the balance of the fund from the award for the taking, such work shall be approved in the manner required for further improvement of the Common Elements under Section 6.04 above.

(iii) The shares in the Common Elements and Limited Common Elements appurtenant to the Units which continue as a part of the Condominium Property shall be equitably adjusted to distribute the ownership to the Common Elements among the reduced number of Owners. This shall be done by recomputing the shares of such continuing Owners in the Common Elements as percentages of the total of the shares of such Owners as they exist prior to the adjustment.

(iv) If the amount of the award for taking is not sufficient to pay the market value of the condemned Unit to the Owner and to restore the remaining portion of the Unit in condition for use as a part of the Common Elements, the additional funds required for such purposes shall be raised by assessments against all of the Owners who will continue as Owners of the Units after the changes in the Condominium Property affected by the taking. Such assessment shall be made in proportion to the share of such Owners in the Common Elements after the changes affected by the taking.

(c) If the market value of a Unit prior to the taking cannot be determined by agreement between the Owner and the Mortgagee and the Association within thirty (30) days after notice by any such party that agreement cannot be reached, such value shall be determined by three independent qualified appraisers with one appraiser to be selected by the Association, one appraiser to be selected by the Owner and Mortgagee, and the third appraiser to be selected by the two appraisers so appointed, and the fair market value of the Unit shall be deemed to be the average of the two appraisals of the fair market value of the Unit made by said appraisers having the least difference in amount. The cost of such

appraisal shall be assessed against all Owners in the shares of the Owners in the Common Elements as they existed prior to the changes affected by the taking.

(d) Changes in the Units, in the ownership of the Common Elements and Limited Common Elements, and in the share of liability for Common Expenses and Limited Common Expenses which are affected by eminent domain, shall be evidenced by an amendment of this Declaration which needs be approved only by a majority of the Board of Directors of the Association.

Section 10.03 Association Appointed As Attorney-In-Fact for Unit Owners.

The Association shall be appointed as attorney-in-fact for each Unit Owner for the purpose of representing such Unit Owners in any proceeding, negotiation, settlement or agreement arising from the condemnation or taking by eminent domain of the Condominium Property or any portion thereof.

ARTICLE XI

TERMINATION

Section 11.01 Termination by Consent. Except in the event of a condemnation of all Units by eminent domain, this Declaration and plan of condominium ownership established herein may only otherwise be terminated by the consent of the Owners of Units to which at least eighty (80%) of the votes in the Association are allocated and sixty-seven percent (67%) of the votes of all Mortgagees, in which event the termination of the Condominium shall be by such plans as may be then adopted by at least eighty (80%) percent of the votes in the Association and sixty-seven (67%) percent of the votes of the Mortgagees. Such election to terminate this Declaration and the plan of condominium ownership established herein shall be evidenced by a termination agreement executed in writing by all of the aforesaid parties in recordable form, and such instrument shall be recorded in the Probate Office. Any termination agreement and the ownership of the property which constituted the Condominium Property and all other assets of the Association shall be subject to Section 35-8A-218 of the Act.

Section 11.02 The Association Appointed as Attorney-In-Fact for Unit Owners. The Association shall be appointed as attorney-in-fact for each Unit Owner for the purpose of representing such Unit Owners in any proceeding, negotiation, settlement or agreement arising from the termination of this Declaration and plan of condominium ownership established herein.

ARTICLE XII

CONTROL OF THE ASSOCIATION

Section 12.01 Election of Board of Directors. Developer may control by appointing and removing officers and members of the Board until the earlier of (a) sixty (60) days have elapsed since seventy-five percent (75%) of the Units in the Condominium which may ever be created have been conveyed to purchasers of Units other than the Developer, (b) two (2) years

have elapsed since Developer has ceased offering Units in the Condominium for sale in the ordinary course of business, or (c) the Developer elects, at its option, to terminate control of the Association, whichever first occurs. Not later than ninety (90) days after conveyance of twenty-five percent (25%) of the Units which may ever be created to Unit Owners other than the Developer, the Unit Owners other than Developer shall be entitled to elect one member or twenty-five percent (25%) of the members of the Board. Not later than ninety (90) days after conveyance of fifty percent (50%) of the Units which may ever be created to Unit Owners other than Developer, not less than thirty-three and one-third percent (33 $\frac{1}{3}$ %) of the members of the Board may be elected by the Unit Owners. Within sixty (60) days of the date of termination of control of the Association by the Developer, the Board of Directors shall call and give not less than ten (10), nor more than thirty (30), days' notice of a special meeting of the membership for the purpose of electing the members of the Board of Directors.

Section 12.02 Notice of Meeting. Within sixty (60) days before the date of termination of control of the Association by the Developer, the Association shall call and give not less than ten (10) days nor more than thirty (30) days' notice of a meeting of the Unit Owners for the purpose of electing the members of the Board of Directors of the Association. Such meeting shall be called and the notice given in accordance with the Bylaws.

Section 12.03 Status of Unsold Units.

(a) Developer shall be deemed to be the Owner of each Unit which has not been conveyed to a person other than the Developer. Unless otherwise provided in the Condominium Documents, the Developer shall be entitled to all rights and privileges available to, and shall be subject to any and all obligations and duties imposed upon, the Owner of any such Unit under the Condominium Documents.

(b) Any person having a first mortgage lien against any Unit which has not been conveyed to a person other than Developer, whether under a blanket mortgage affecting the Condominium Property generally or under a mortgage on one or more specific Units, shall be deemed to be a Mortgagee with respect to any such Unit, and shall be entitled to all rights and privileges available to a Mortgagee of any such Unit under the Condominium Documents so long as the Mortgagee has given notice to the Association that it is a Mortgagee.

(c) During the first year of operation of the Association, the Association may modify the initial operating budget to account for items under warranty, less than full occupancy and all other startup cost savings. The working capital fund deposit of an amount equal to three (3) months assessment shall be based on the full estimated operating budget, however. Notwithstanding the provisions of Sections 4.02 and 12.03 (a) above, no assessments shall be imposed by the Association against the Developer as the Owner of unsold Units until sixty (60) days after the conveyance of the first Unit. During such period, Developer shall be responsible for the Common Expenses and Limited Common Expenses of the Condominium Property, except that the Developer shall be entitled to use and apply to the payment of such Common Expenses and Limited Common Expenses any and all assessments made against the Unit Owners other than Developer and collected by

the Association for Common Expenses and Limited Common Expenses, including the assessments paid by each Owner at closing as working capital.

Section 12.04 Professional Management and Other Contracts. Any management contract, employment contract or lease of recreational facilities or any agreement between the Association and an affiliate of the Developer entered into by the Association prior to the passage of control of the Association from the Developer pursuant to Section 12.01 above shall provide the following:

(a) The Association shall have the right of termination which is exercisable without penalty any time upon not more than ninety (90) days' written notice to the other party thereto; and

(b) The Association shall have a right of termination for cause which is exercisable without penalty at any time upon not more than thirty (30) days' written notice to the other party thereto.

ARTICLE XIII

AMENDMENT

Section 13.01 Amendment. The Declaration may be amended in the following manner:

(a) Developer.

(i) The Developer reserves the right to amend the Bylaws of the Association until such time as Developer relinquishes control of the Association as provided in Section 12.01.

(ii) The Developer reserves the right to amend the Declaration for any reason so long as there is no Unit Owner other than the Developer.

(iii) The Developer reserves the right at any time to amend the Declaration without the consent of other Owners if required by any Mortgagee as a condition of making a loan secured by an interest in a Unit in order to meet the requirements of the Federal Home Loan Mortgage Corporation or the Federal National Mortgage Association; provided, that any such changes or amendments requested by a Mortgagee shall not materially affect the rights of the Unit Owners or the value of the Condominium Unit or the undivided interest in the Common Elements or Limited Common Elements, if any, attributable to each Unit Owner.

(iv) The Developer reserves the right to amend the Declaration to exercise any and all development rights and/or special declarant rights set forth in the Declaration, and to make Limited Common Element assignments or reassignments or to correct any scrivener's errors in the Declaration.

(b) At such time as there is a Unit Owner other than the Developer, then, in addition to the amendments permitted under Paragraph (a) above, the Declaration may be amended in the following manner:

(i) A proposal to amend the Declaration may be considered at any meeting of the members of the Association called for that purpose in accordance with the provisions of the Bylaws; provided that the Association provides prior written notice of such meeting to the Mortgagees as provided in Section 8.01 of the Declaration. The proposal to amend the Declaration must be approved by the affirmative vote of the members representing not less than sixty-seven percent (67%) of the total allocated votes of the Association and by the affirmative vote of the Mortgagees representing fifty-one percent (51%) of the total allocated votes of the Units subject to Mortgages.

(ii) Notwithstanding the foregoing, no amendment to the Declaration shall:

(A) change a Unit, including the ownership in Common Elements, responsibility for Common Expenses and voting rights, without the prior written approval of the Unit Owner or Unit Owners so affected and prior written approval of the holders of record of any mortgage or other liens on the Unit or Units so affected unless amended pursuant to Developer's right to create additional Units; or

(B) change, impair or prejudice the rights of Developer or change the provisions of this Declaration with respect to the Developer's rights hereunder without Developer's prior written approval.

Section 13.02 Effectiveness of Amendments. A copy of each amendment adopted pursuant to Section 13.01(a) above need only be signed by the Developer and shall be effective when recorded in the Probate Office. A copy of each amendment adopted shall be certified by the President or a Vice President and Secretary of the Association as having been duly adopted, and shall be effective when recorded in the Probate Office.

ARTICLE XIV

DISPUTE RESOLUTION

Section 14.01 Agreement to Resolve Disputes Without Litigation.

(a) Developer, the Association and its officers, directors, and committee members, all Owners, all persons subject to this Declaration, and any person not otherwise subject to this Declaration who agrees to submit to this Article (collectively, "Bound Party"), agree that it is in the best interest of all concerned to resolve disputes involving the Condominium, the Association and/or the Owners without the emotional and financial costs of litigation. Accordingly, each Bound Party agrees not to file suit in any court with

respect to a Claim (hereinafter defined), and to submit such Claim to the alternative dispute resolution procedures set forth in Section 14.02 in a good faith effort to resolve such Claim.

(b) As used in this Article, the term “Claim” shall refer to any claim, grievance or dispute arising out of or relating to:

- (i) the interpretation, application, or enforcement of the Condominium Documents;
- (ii) the rights, obligations and duties of any Bound Party under the Condominium Documents or related argument; or
- (iii) the construction of the Condominium Property;

except that the following shall not be considered “Claims” unless all parties to the matter otherwise agree to submit the matter to the procedures set forth in Section 14.02:

- (iv) any suit by the Association to collect Assessments or other amounts due from any Owner;
- (v) any suit by the Association to obtain a temporary restraining order (or emergency equitable relief) and such ancillary relief as the court may deem necessary in order to maintain the status quo and preserve the Association’s ability to enforce the provisions of this Declaration;
- (vi) any suit between Owners, which does not include Developer or the Association as a party, if such suit asserts a Claim which would constitute a cause of action independent of the Condominium Documents;
- (vii) any suit in which any indispensable party is not a Bound Party except the construction contractor or sales contractor or Condominium architect.
- (viii) any suit as to which any applicable statute of limitations would expire within one hundred eighty (180) days of giving the Notice required by Section 14.02(a), unless the party or parties against whom the Claim is made agree to toll the statute of limitations as to such Claim for such period as may reasonably be necessary to comply with this Article.

Section 14.02 Dispute Resolution Procedures.

(a) Notice. The Bound Party asserting a Claim (“Claimant”) against another Bound Party (“Respondent”) shall give written notice (“Notice”) to each Respondent and to the Board stating plainly and concisely:

- (i) the nature of the Claim, including the persons involved and the Respondent’s role in the Claim;

(ii) the legal basis of the Claim (i.e., the specific authority out of which the Claim arises);

(iii) the Claimant's proposed resolution or remedy; and

(iv) the Claimant's desire to meet with the Respondent to discuss in good faith ways to resolve the Claim.

(b) Negotiation. The Claimant and Respondent shall make every reasonable effort to meet in person and confer for the purpose of resolving the Claim by good faith negotiation. If requested in writing, accompanied by a copy of the Notice, the Board may appoint a representative to assist the parties in negotiating a resolution of the Claim.

(c) Mediation. If the parties have not resolved the Claim through negotiation within thirty (30) days of the date of the Notice described in Section 14.02(a) (or within such other period as the parties may agree upon), the Claimant shall have thirty (30) additional days to submit the Claim to mediation with an entity designated by the Association (if the Association is not a party to the Claim) or to an independent agency or individual providing dispute resolution services in the State of Alabama selected by both sides if the Association is a party. If the Claimant does not submit the Claim to mediation within such time, or does not appear for the mediation when scheduled, the Claimant shall be deemed to have waived the Claim, and the Respondent shall be relieved of any and all liability to the Claimant (but not third parties) on account of such Claim. If the parties do not settle the Claim within thirty (30) days after submission of the matter to mediation, or within such time as determined reasonable by the mediator, the mediator shall issue a notice of termination of the mediation proceedings indicating that the parties are at an impasse and the date that mediation was terminated. The Claimant shall thereafter be required to initiate arbitration proceedings on the Claim, as set forth in Section 14.02(e) below. Each party shall bear its own costs of the mediation, including attorneys' fees, and each party shall share equally all fees charged by the mediator.

(d) Settlement. Any settlement of the Claim through negotiation or mediation shall be documented in writing and signed by the parties. If any party thereafter fails to abide by the terms of such agreement, then any other party may file suit or initiate administrative proceedings to enforce such agreement without the need to again comply with the procedures set forth in this Section. In such event, the party taking action to enforce the agreement or award shall, upon prevailing, be entitled to recover from the non-complying party (or if more than one non-complying party, from all such parties in equal proportions) all costs incurred in enforcing such agreement or award, including, without limitation, attorneys' fees and court costs.

(e) **Arbitration; No Trial by Jury**. All Claims, Disputes regarding Alleged Defects or other matters in question arising out of, or relating in any way to the Condominium or the breach of and contract between the Bound Parties that are not resolved by negotiation or mediation shall be resolved by binding arbitration by a single arbitrator in Jefferson County, Alabama in accordance with the Commercial Arbitration Rules of the American Arbitration Association then in effect.

EACH PARTY ACKNOWLEDGES THAT HE OR SHE IS KNOWINGLY WAIVING THE RIGHT TO A TRIAL BY JURY RELATING TO ALL CLAIMS.

All disputes concerning the arbitrability of any Claim or the enforceability or scope of this provision shall be subject to the same binding arbitration. The parties shall bear equally the cost of the arbitrator, and each party shall otherwise bear their own costs; provided, the arbitrator shall have the authority to award costs as a part of this award to the prevailing party. The arbitrator shall follow the law applicable to any Claim and shall be empowered to award any damages or other relief which would be available under the law applicable to any such Claim. In no event shall the demand for arbitration be made after the date when institution of legal or equitable proceedings based on such claim, dispute or other matter in question would be barred by the applicable statute of limitations. The determination of the arbitrator shall be final, binding on the parties, and non-appealable and may be entered in any court of competent jurisdiction to enforce it. The parties acknowledge and agree that the transactions contemplated by, and relating to, the Condominium, which may include the use of materials and components which are obtained from out-of-state and which otherwise include the use of interstate mails, roadways and commerce, involve interstate commerce, as that term is defined in the Federal Arbitration Act, 9 U.S.C. § 2.

Section 14.03 Initiation of Litigation by Association. In addition to compliance with the foregoing alternative dispute resolution procedures, if applicable, the Association shall not initiate any judicial or administrative proceedings, or arbitration unless first approved by a vote of the members entitled to cast sixty-six and two-thirds percent (66.67%) of the votes in the Association, except that no such approval shall be required for actions or proceedings:

- (a) initiated during the period that the Developer controls the Association;
- (b) initiated to enforce the provisions of this Declaration, including collection of assessments and foreclosure of liens;
- (c) initiated to challenge property taxation or condemnation proceedings;
- (d) initiated against any contractor, vendor, or supplier of goods or services arising out of a contract for services or supplies; or
- (e) to defend claims filed against the Association or to assert counterclaims in proceedings instituted against it.

This Section 14.03 shall not be amended unless such amendment is approved by the same percentage of votes necessary to institute proceedings.

ARTICLE XV

MISCELLANEOUS

Section 15.01 Rights and Powers of Successors and Assignees. The rights and powers reserved to or exercisable by the Developer under the Condominium Documents or the Act may be exercised by any successor or assignee of the Developer (i) who acquires title from the Developer by foreclosure or other judicial sale or deed in lieu of foreclosure, or (ii) to whom the Developer specifically assigns such rights and powers in an instrument recorded in the Probate Office.

Section 15.02 Headings. The captions herein are used solely as a matter of convenience and shall not define, limit or expand any term or provision of this Declaration.

Section 15.03 Mold and Mildew; Potential for Water Intrusion. Mold and/or mildew can grow in any portion of the Condominium that is exposed to elevated levels of moisture. Each Unit Owner agrees to: (1) regularly inspect the parts of the Condominium that the Unit Owners maintain; and which are visible and accessible without having to first conduct invasive testing, for the existence of mold, mildew, and/or water intrusion and/or damage; (2) upon discovery, immediately repair in a good and workmanlike condition the source of any water intrusion in the parts of the Condominium that they respectively maintain; (3) remediate or replace any building material located in the parts of the Condominium that they maintain that has absorbed water or moisture as a result of water intrusion; and (4) promptly and regularly remediate all mold and/or mildew discovered in the parts of the Condominium that they maintain in accordance with current industry-accepted methods. In addition, each Unit Owner shall notify the Association and the Developer of the discovery of mold, mildew, and/or water intrusion and/or damage in their Units, and the Association shall notify the Developer of the discovery of mold, mildew, and/or water intrusion and/or damage in any part of the Condominium should the Developer own any Units at that time.

Section 15.04 Gender/Number. Whenever the context so permits, the use of the plural shall include the singular, the singular shall include the plural, and any gender shall be deemed to include all genders.

Section 15.05 Exhibits. Exhibits “A,” “B,” “C,” “D,” “E,” “F” and “G” attached to this Declaration are an integral part of this Declaration.

Section 15.06 Invalidity and Severability. It is the intention of the Developer that the provisions of this Declaration are severable so that if any provision is invalid or void under any applicable federal, state or local law or ordinance, decree, order, judgment or otherwise, the remainder shall be unaffected thereby.

Section 15.07 Interpretation. The provisions of this Declaration shall be liberally construed to effectuate its purpose of creating a uniform plan for the development and operation of a condominium project. Failure to enforce any provision hereof shall not constitute a waiver of the right to enforce said provision or any other provision hereof.

[SIGNATURE PAGE FOLLOWS]

IN WITNESS WHEREOF, the Developer has hereunto set its signature and seal on the day and year first above written.

[XYZ] DEVELOPMENT, LLC, an Alabama limited liability company

By:
Its:_____

STATE OF ALABAMA)
COUNTY OF JEFFERSON)

I, the undersigned, a Notary Public in and for said County in said State, hereby certify that _____ as _____ of **[XYZ] DEVELOPMENT, LLC**, an Alabama limited liability company whose name is signed to the foregoing Declaration of Condominium, and who is known to me, acknowledged before me on this day that, being informed of the contents of the above and foregoing Declaration of Condominium, executed the same voluntarily on the date the same bears date on behalf of said company.

Given under my hand and official seal of office this _____ day of _____ 20____.

[NOTARIAL SEAL]

Notary Public
My Commission Expires:_____

[MORTGAGEE]

By: _____
Name: _____
Title: _____

STATE OF _____)
COUNTY OF _____)

I, the undersigned, a Notary Public in and for said County in said State, hereby certify that _____ as _____ of **[MORTGAGEE]**, whose name is signed to the foregoing Declaration of Condominium, and who is known to me, acknowledged before me on this day that, being informed of the contents of the above and foregoing Declaration of Condominium, executed the same voluntarily on the date the same bears date on behalf of said company.

Given under my hand and official seal of office this _____ day of _____ 20__.

Notary Public

My Commission Expires: _____

[NOTARIAL SEAL]

EXHIBIT A
LEGAL DESCRIPTION OF PROPERTY

EXHIBIT B
ADDITIONAL PROPERTY

EXHIBIT C
BYLAWS OF
[XYZ] CONDOMINIUM ASSOCIATION, INC.

EXHIBIT D
PLAT AND PLANS

[See Attached]

EXHIBIT E**COMMON ELEMENT ALLOCATED INTERESTS, LIMITED
COMMON ELEMENT ASSIGNMENTS AND VOTES**

Unit #	Limited Common Element Parking Space Assignment	Limited Common Element Storage Space Assignment	Vote(s)	% Common Element Allocated Interest
Unit				%
Unit				%
TOTAL				100%

EXHIBIT F**ALLOCATED INTEREST UPON
ADDITION OF ADDITIONAL PROPERTY**

Upon addition of any portion of the Additional Property or any additional Units to the Condominium, the Common Element and Limited Common Element Allocated Interest assigned to the additional Units shall be calculated by dividing the approximate square footage of each additional Unit by the total square footage of all Units then-existing in the Condominium. The Allocated Interest of all previously-existing Units in the Condominium will likewise be reduced by dividing the approximate square footage of the Unit by the square footage of all Units then-existing. The square footage of the Unit to be used for each Unit is the square footage calculated from the architectural plans by a computer program measuring from the interior surface of the exterior boundary walls of the Unit. Upon adjustment of the Allocated Interests, the Limited Common Expense liability shall likewise be adjusted.

Upon addition of any portion of the Additional Property, the votes for each additional Unit shall be the comparable number of votes assigned to Units previously existing in the Condominium of a comparable size.

EXHIBIT G

EASEMENTS AND RESTRICTIONS OF RECORD